



SLIMLINE/FRONTLINE

01.01.2023



SLIMLINE/FRONTLINE

Our Slimline/Frontline Shelving Systems are the essence of many years of experience and success. This flexible product concept has evolved over the years and the modular structure and the large number of standard components ensure ideal room utilization and rational accommodation of all relevant functions. In addition the flexibility of the system allows a variety of individual solutions which our design teams bring to life for the individual library.

You will find all our standard products in this overview. For additional inspiration we invite you to visit our website where you can find project inspiration from our latest projects around the world.

The Slimline/Frontline shelving systems are shown in many creative configurations and our broad portfolio of library furniture provides endless possibilities. Please contact our professional sales teams for inspiration.



FSC	4
DESIGN OPTIONS	7
TECHNICAL SPECIFICATIONS	10

CONFIGURATIONS

SLIMLINE SHELVING SYSTEM	14
Single-sided configurations with shelves	16
Double-sided configurations with shelves	18
End panel bay configurations with shelves	20
FRONTLINE SHELVING SYSTEM (FSC)	22
Single-sided configurations without shelves - 22 mm	24
Double-sided configurations without shelves - 22 mm	26
Single-sided configurations with shelves - 22 mm	28
Double-sided configurations with shelves - 22 mm	30
Single-sided configurations with shelves - 38 mm	32
Double-sided configurations with shelves - 38 mm	33
End panel bay configurations with shelves	34
FRONTLINE SQUARE (FSC)	36
Configurations without shelves - veneer	38
Configurations without shelves - painted.....	39
Configurations with shelves - veneer	40
Configurations with shelves - painted	41
ORDRUP SQUARE	42
Configurations - veneer	44
Configurations - painted.....	45

COMPONENTS

CHECK LIST	47
PANELS	48
Panels.....	48
Display end panels.....	51
BACK PANELS	52
Back panels.....	52
METAL BACK FRAMES	54
Metal back frame.....	54
OTHER COMPONENTS	55
Plinths, frame for castors & castors	55
SHELVES	56
Steel shelves	56
Steel top shelves	58
Steel sloping shelves	61
Wooden shelves	62
Wooden top shelves	63
Wooden bottom shelves	64
Wooden sloping shelves	64
FUNCTIONS	66
Book supports.....	67
Browsers	68
Multimedia	72
Magazine display & storage	74
Cabinets.....	77
Work stations	78
Signage.....	79
LIGHTING	80
Book Big lighting.....	81



WOOD FROM SUSTAINABLE FORESTRY

We are committed to increasing the share of sustainable raw wooden material in our products and thereby support sustainable forestry – for a better world.

Governments and local authorities are specifying the supply of legal and responsibly sourced wood in their procurement policies.

We have invested in a Chain-of-Custody Multi-site certificate (FSC-C 144988), issued by FSC®, which documents, that we can offer wood from sustainable forestry. FSC (Forest Stewardship Council) is an international labelling scheme, that documents that FSC labelled products originate from sustainable forestry.

Working with certified suppliers, we can now offer our Frontline shelving system as fully FSC Mix certified (noted in this document with FSC).



WHAT IS SUSTAINABLE FORESTRY?

According to the FSC, forests, managed according to their principles and criteria, mean fair conditions for workers, respect for indigenous communities and local populations as well as strict environmental controls.

The FSC label guarantees that the trees that are harvested are replaced or allowed to regenerate naturally.

All the wood is tracked from the forest to the store. Every link between the forest and the consumer is certified to make it clearly identifiable which wood is from sustainable forestry and which is not.

Source: Forest Stewardship Council
<http://www.fsc-uk.org/en-uk>



Frontline shelving system
Wood from sustainable forestry



Frontline shelving system
Wood from sustainable forestry



DESIGN OPTIONS

STEEL COMPONENTS - PAINTED

A PRICE GROUP - BASIS PRICE (smooth finish)



A03
Traffic white
RAL 9016
Gloss 75-90



A02
Oyster white
RAL 1013
Gloss 40-50



A22
Moss green
RAL 6005
Gloss 71-85

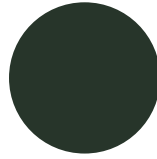

A26
Fir green
RAL 6009
Gloss 71-85

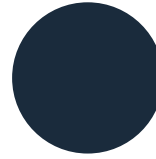

A12
Steel blue
RAL 5011
Gloss 71-85



A13
Light grey
RAL 7035
Gloss 71-85

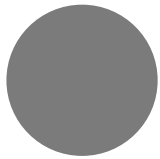

A15
Dusty grey
RAL 7037
Gloss 71-85

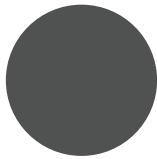

A16
Traffic grey
RAL 7043
Gloss 71-85

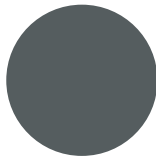

A17
Basalt grey
RAL 7012
Gloss 71-85

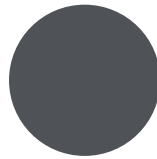

A18
Slate grey
RAL 7015
Gloss 71-85

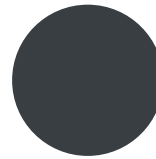

A19
Anthracite grey
RAL 7016
Gloss 71-85

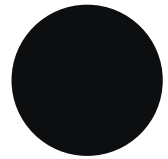

A25
Jet black
RAL 9005
Gloss 71-85

B PRICE GROUP - BASIS PRICE WITH 7% SURCHARGE (smooth finish)



A01
Pure white
RAL 9010
Gloss 71-85

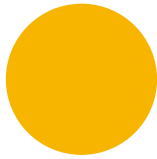

A04
Traffic yellow
RAL 1023
Gloss 71-85

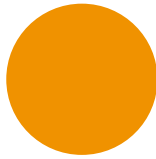

A05
Sun yellow
RAL 1037
Gloss 71-85

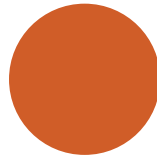

A06
Signal orange
RAL 2010
Gloss 71-85

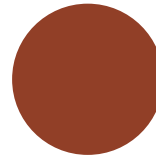

A07
Pearl orange
RAL 2013
Gloss 65-85

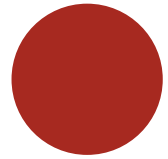

A08
Flame red
RAL 3000
Gloss 71-85

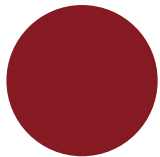

A09
Ruby red
RAL 3003
Gloss 71-85



A21
Reseda green
RAL 6011
Gloss 71-85

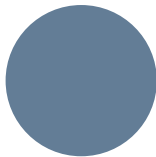

A10
Pigeon blue
RAL 5014
Gloss 71-85

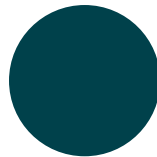

A11
Ocean blue
RAL 5020
Gloss 71-85

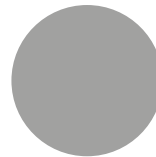

A14
White aluminium
RAL 9006
Gloss 50-70

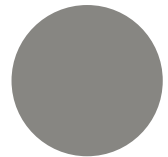

A31
Grey aluminium
RAL 9007
Gloss 50-70

B PRICE GROUP - BASIS PRICE WITH 7% SURCHARGE (textured finish)



A27
Pure white
RAL 9010

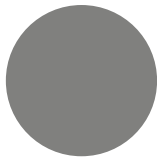

A29
Concertina grey

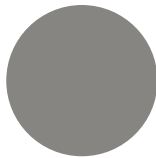

A28
Grey aluminium
RAL 9007

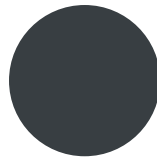

A23
Anthracite grey
RAL 7016

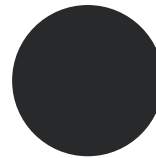

A24
Graphite black
RAL 9011

Note:

- Other RAL/NCS colours have a starter fee of GBP 215 / EUR 250 and a surcharge of 15%. A higher surcharge for colours with "metallic" look or different surface textures must be expected.
- See specific colour for steel gloss specification. Special requests outside specified gloss range are not covered by the above surcharges.
- Chrome, electro galvanised and aluminium parts are not available in other colours.
- Products such as e.g. castors and accurides cannot be produced in other colours than described in the price list.

DESIGN OPTIONS

WOODEN COMPONENTS - PAINTED

A PRICE GROUP - BASIS PRICE

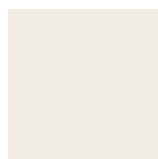

A01
Pure white
RAL 9010
Gloss 20-30



A02
Oyster white
RAL 1013
Gloss 20-30

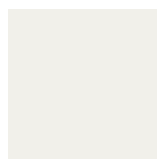

A03
Traffic white
RAL 9016
Gloss 20-30



A04
Traffic yellow
RAL 1023
Gloss 20-30



A05
Sun yellow
RAL 1037
Gloss 20-30



A06
Signal orange
RAL 2010
Gloss 20-30



A07
Pearl orange
RAL 2013
Gloss 20-30



A08
Flame red
RAL 3000
Gloss 20-30



A09
Ruby red
RAL 3003
Gloss 20-30



A21
Reseda green
RAL 6011
Gloss 20-30



A22
Moss green
RAL 6005
Gloss 20-30



A26
Fir green
RAL 6009
Gloss 20-30



A10
Pigeon blue
RAL 5014
Gloss 20-30



A11
Ocean blue
RAL 5020
Gloss 20-30



A12
Steel blue
RAL 5011
Gloss 20-30



A13
Light grey
RAL 7035
Gloss 20-30



A14
White aluminium
RAL 9006
Gloss 20-30



A31
Grey aluminium
RAL 9007
Gloss 20-30



A15
Dusty grey
RAL 7037
Gloss 20-30

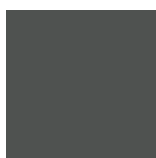

A16
Traffic grey
RAL 7043
Gloss 20-30



A17
Basalt grey
RAL 7012
Gloss 20-30



A18
Slate grey
RAL 7015
Gloss 20-30



A19
Anthracite grey
RAL 7016
Gloss 20-30



A25
Jet black
RAL 9005
Gloss 20-30

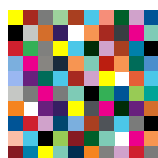

Any RAL/NCS colour
Gloss 20-30

Note:

- The above selection of colours match our steel colours. Note that you can order any RAL/NCS colour without surcharge.
- A surcharge for colours with "metallic" look or different surface textures must be expected, please contact Customer Service.

DESIGN OPTIONS

WOODEN COMPONENTS - VENEER

A PRICE GROUP - BASIS PRICE



69
Birch



55
Light steamed
beech



66
Oak



67
Maple

D PRICE GROUP - BASIS PRICE WITH 20% SURCHARGE



68
Ash

Note:

- The wooden veneers can also be stained for a surcharge, please contact Customer Service. Samples will be forwarded for approval.

TECHNICAL SPECIFICATIONS

GENERAL SPECIFICATIONS

DIMENSIONS

Dimensions of complete bays in available modules and heights can be found in each catalogue section which include complete configurations. See index page for overview.

MAXIMUM LOAD

Steel top shelf without backedge - max. load of 25 kg

Steel shelf with backedge - max. load of 80 kg

Wooden top shelf without backedge - particleboard - max. load of 25 kg

Wooden shelf with/without backedge - block board - max. load of 80 kg

Steel browser with pull-out frame - max. load of 40 kg

MOBILE SHELVING UNITS/WHEEL STANDS AND CASTORS

Only double-sided shelving units with a max. height of 152 cm and maximum 3 bays can be mounted with castors. Castors are available with or without brakes. Max. load of 90 kg per castor.

STABILITY

All panels are provided with adjustable feet that can be adjusted even when the system is loaded. Single-sided shelving is supplied with wall securement.

ROUNDED EDGES

All storage units and brackets have rounded edges.

BROWSERS

It is important to remember the following, when installing browsers in a shelving system:

- Browsers without tubes are meant for low medias with a maximum height of 20 cm, meaning they are not suited for e.g. picture books, as they may tip over the edge. If you wish to use store/display tall medias in browsers, then it is recommended to use single browsers with tubes, 20 cm in height and to place the books as far back as possible.
- The panel must minimally be the same depth as the browser, meaning that a 30 cm deep browser must only be installed on a 30 or 40 cm deep panel and a 40 cm deep browser on a 40 cm deep panel.
- We recommend that all shelving systems with browsers are either fixed to the floor or wall.
- Ensure that children do not play/crawl/hang on the shelving system.
- The maximum weight for each pull-out browser is 45 kg.

ASSEMBLY

All wooden shelving units come knocked-down. Assembly guidelines can be found on our website.

TECHNICAL SPECIFICATIONS

STEEL COMPONENTS

STEEL COMPONENTS

are powder coated with standard polyester based powders that secures high UV resistance. Powders comply with EN 45545 (fire protection - similar to DIN 4201). Thickness of the coating is 60-80 µm.

The powder used includes:

- no azo dyes that can release a leaving carcinogenic amine component
- no triglycidylisocyanurate (TGIC)
- no heavy steel-containing pigments such as lead and cadmium
- no volatiles

Antibacterial equipping of surfaces upon request.

STEEL METAL FRAMES

are made of 30 x 20 x 1.5 mm steel tubes. The metal frame is easy to assemble between the panels.

STEEL BRACKETS

are made of 1.4 mm sheet steel.

STEEL SHELVES/BROWSERS/CABINETS/PULL-OUT SHELVES

are made of 0.9 mm sheet steel. The flat steel shelves have a 25 mm high front edge. Flat steel shelves can be mounted in a sloping position by changing brackets.

TECHNICAL SPECIFICATIONS

WOODEN COMPONENTS

DENSITY

Particle board has a density of 600-700 kg/m³

Block board has a density of 602 kg/m³ (+/- 2 %)

MDF has a density of 700 kg/m³ (+/- 5-7 %)

VENEERED WOODEN COMPONENTS

are mainly lacquered with UV-lacquer. See Design Options for veneer specifications.

VENEERED PANELS

are made of 22 mm particle board and are veneered with 0.6 mm veneer. All edges on the panels have a 2 mm veneer edge. The panels have two holes in the bottom for adjustable feet.

VENEERED DISPLAY END PANELS

are made of 22 mm MDF and are veneered with 0.6 mm veneer. All edges on Frontline panels have a 2 mm veneer edge. Slimline panels have vertical edges with a 32 mm solid wooden edge and horizontal edges with a 2 mm veneer edge. The panels have two holes in the bottom for adjustable feet.

VENEERED END PANELS FOR FRONTLINE SQUARE

are made of 22 mm MDF and are veneered with 0.6 mm veneer. All edges have a 2 mm veneer edge.

VENEERED BACK PANELS

are made of 16 mm particle board and are veneered with 0.6 mm veneer. The horizontal edges have a 2 mm veneer edge. The vertical edges are not banded, as they are not exposed after assembly of the back panel.

VENEERED SHELVES

are made of 22 mm block board and are veneered with 0.6 mm veneer. The front and back edges have a 2 mm veneer edge.

VENEERED TOP SHELVES

are made of 22 mm particleboard and are veneered with 0.6 mm veneer. The front and back edges have a 2 mm veneer edge.

VENEERED CORNER SHELVES

are made of 22 mm particleboard and are veneered with 0.6 mm veneer. The straight edges have a 2 mm veneer edge and the front has a 1 mm wooden edge strip.

VENEERED PLINTHS

are made of 19 mm particleboard and are veneered with 0.6 mm veneer on the front. The top edge have a 2 mm veneer edge.

PAINTED WOODEN COMPONENTS

are made of MDF (medium density fibre board) which is painted with acid lacquer. Standard components have gloss 20 - 30. See Design Options for colour specifications.

PAINTED PANELS

are made of 22 mm MDF. The panels have a wooden based edge on the lower edge to strengthen the end panel and have two holes in the bottom for adjustable feet.

PAINTED DISPLAY END PANELS

are made of 22 mm MDF. The panels have a wooden based edge on the lower edge to strengthen the end panel and have two holes in the bottom for adjustable feet.

PAINTED END PANELS FOR FRONTLINE SQUARE

are made of 22 mm MDF.

TECHNICAL SPECIFICATIONS

WOODEN COMPONENTS

PAINTED BACK PANELS

are made of 16 mm MDF and are painted on all sides and edges.

PAINTED SHELVES

are made of 22 mm blockboard with 3 mm MDF.

PAINTED TOP SHELVES

are made of 22 mm MDF.

PAINTED PLINTHS

are made of 19 mm MDF.

MELAMINE COATED WOODEN COMPONENTS

MELAMINE BACK PANELS

are made of 16 mm particleboard. The horizontal edges are banded with a 4 mm flat edging of ABS. The vertical edges are not banded, as they are not exposed after assembly of the back panel.

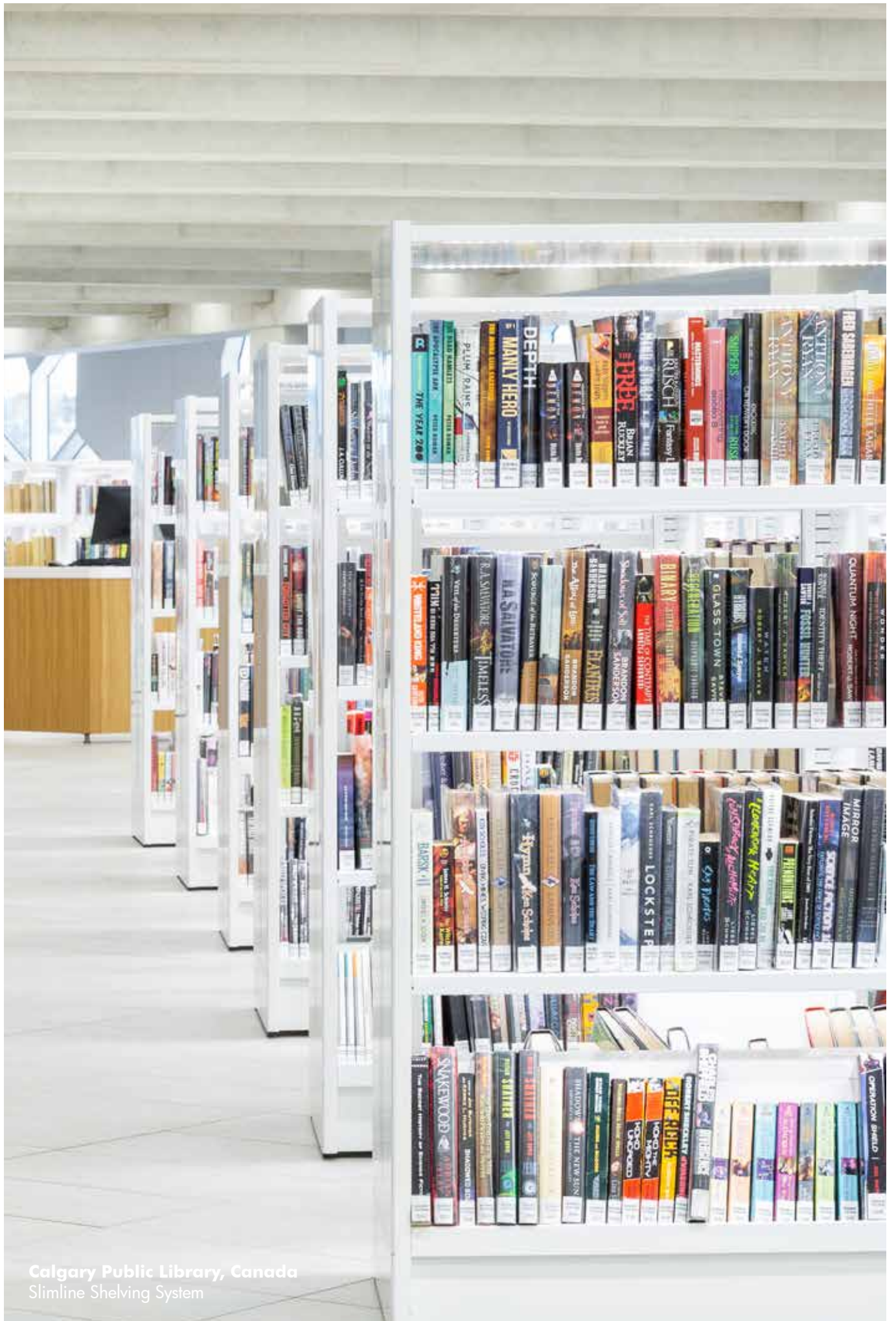

Calgary Public Library, Canada
Slimline Shelving System

SLIMLINE SHELVING SYSTEM

The following pages will show basic configurations of the Slimline Shelving System.

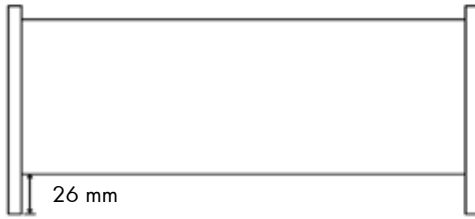

Slimline comes with a 4 mm flat front edge of solid wood. The distance between the front edge of the end panel and the front edge of the shelf is 26 mm.

Slimline configurations are delivered as standard in light steamed beech veneer, no. 55 or birch veneer, no. 69. They can also be delivered in painted MDF in any NCS or RAL colour upon request (see Design Options pages 7-9).

HEIGHTS

Slimline shelving comes in 5 heights; 92, 122, 152, 182 and 212 cm. Heights include adjustable feet (max. 2 cm). The shelves are adjustable in 2.5 cm increments.

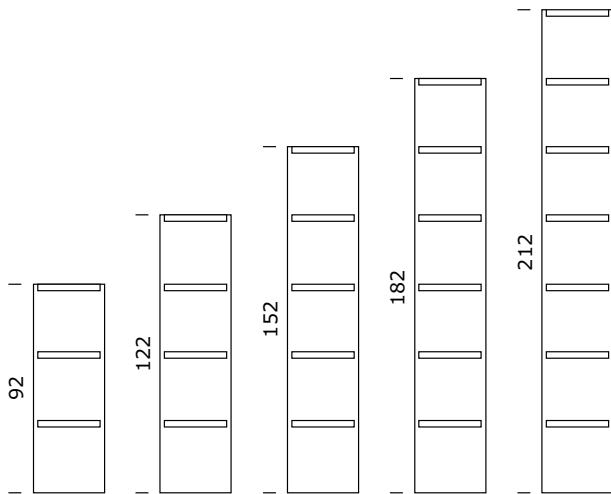

WIDTHS

The bays are available in 75, 90 and 100 cm modules and as starter and add-on bays. A starter bay has two outside panels while an add-on bay has one intermediate panel.

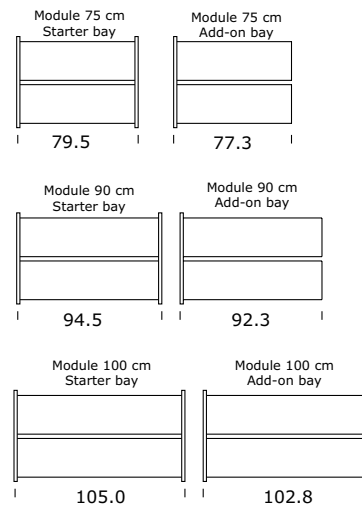

DEPTHS

The panels come in 6 depths:

- 30.8 cm for 25 cm deep shelves
- 35.8 cm for 30 cm deep shelves
- 45.8 cm for 40 cm deep shelves
- 58.9 cm for 2 x 25 cm deep shelves
- 68.9 cm for 2 x 30 cm deep shelves
- 88.9 cm for 2 x 40 cm deep shelves

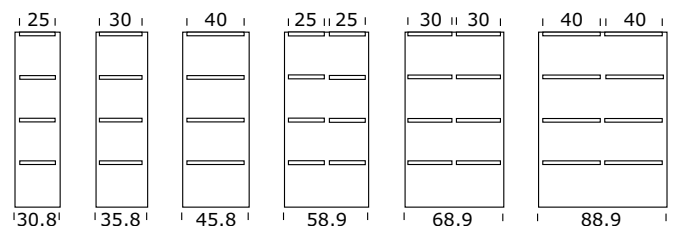

SLIMLINE SHELVING SYSTEM

SINGLE-SIDED - WITH SHELVES

Complete shelving system with panels, metal frame, steel shelves with acrylic backedge, steel top shelf without backedge, brackets, fittings and wall securement. Number of shelves are calculated for optimal shelf spacing for fiction.

Height 92 cm (2 shelves + top shelf)

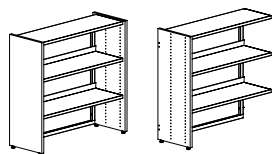

Module cm	Shelf depth cm	Starter bay Item no.	Add-on bay Item no.
75	25	BB78200727122245	BB78201727122245
75	30	BB78200737122245	BB78201737122245
75	40	BB78200747122245	BB78201747122245
90	25	BB78200729122245	BB78201729122245
90	30	BB78200739122245	BB78201739122245
90	40	BB78200749122245	BB78201749122245
100	25	BB78200721122245	BB78201721122245
100	30	BB78200731122245	BB78201731122245
100	40	BB78200741122245	BB78201741122245

Height 122 cm (3 shelves + top shelf)

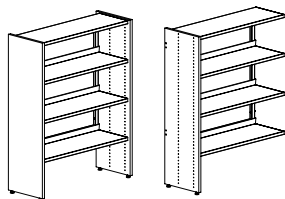

Module cm	Shelf depth cm	Starter bay Item no.	Add-on bay Item no.
75	25	BB78200227123245	BB78201227123245
75	30	BB78200237123245	BB78201237123245
75	40	BB78200247123245	BB78201247123245
90	25	BB78200229123245	BB78201229123245
90	30	BB78200239123245	BB78201239123245
90	40	BB78200249123245	BB78201249123245
100	25	BB78200221123245	BB78201221123245
100	30	BB78200231123245	BB78201231123245
100	40	BB78200241123245	BB78201241123245

Height 152 cm (4 shelves + top shelf)

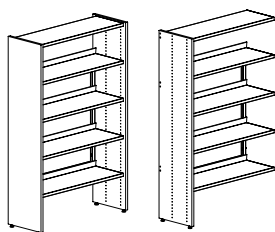

Module cm	Shelf depth cm	Starter bay Item no.	Add-on bay Item no.
75	25	BB78200527124245	BB78201527124245
75	30	BB78200537124245	BB78201537124245
75	40	BB78200547124245	BB78201547124245
90	25	BB78200529124245	BB78201529124245
90	30	BB78200539124245	BB78201539124245
90	40	BB78200549124245	BB78201549124245
100	25	BB78200521124245	BB78201521124245
100	30	BB78200531124245	BB78201531124245
100	40	BB78200541124245	BB78201541124245

Height 182 cm (5 shelves + top shelf)

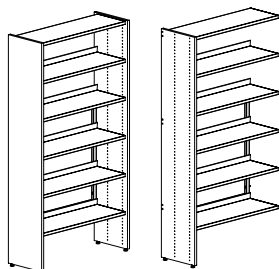

Module cm	Shelf depth cm	Starter bay Item no.	Add-on bay Item no.
75	25	BB78200827125245	BB78201827125245
75	30	BB78200837125245	BB78201837125245
75	40	BB78200847125245	BB78201847125245
90	25	BB78200829125245	BB78201829125245
90	30	BB78200839125245	BB78201839125245
90	40	BB78200849125245	BB78201849125245
100	25	BB78200821125245	BB78201821125245
100	30	BB78200831125245	BB78201831125245
100	40	BB78200841125245	BB78201841125245

SLIMLINE SHELVING SYSTEM

SINGLE-SIDED - WITH SHELVES

Complete shelving system with panels, metal frame, steel shelves with acrylic backedge, steel top shelf without backedge, brackets, fittings and wall securement. Number of shelves are calculated for optimal shelf spacing for fiction.

Height 212 cm (6 shelves + top shelf)

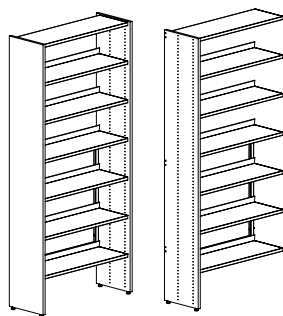

Module cm	Shelf depth cm	Starter bay Item no.	Add-on bay Item no.
75	25	BB78200127126245	BB78201127126245
75	30	BB78200137126245	BB78201137126245
75	40	BB78200147126245	BB78201147126245
90	25	BB78200129126245	BB78201129126245
90	30	BB78200139126245	BB78201139126245
90	40	BB78200149126245	BB78201149126245
100	25	BB78200121126245	BB78201121126245
100	30	BB78200131126245	BB78201131126245
100	40	BB78200141126245	BB78201141126245

SLIMLINE SHELVING SYSTEM

DOUBLE-SIDED - WITH SHELVES

Complete shelving system with panels, metal frame, steel shelves with acrylic backedge, steel top shelf without backedge, brackets, fittings and wall securement. Number of shelves are calculated for optimal shelf spacing for fiction.

Height 92 cm (2 shelves + top shelf on each side)

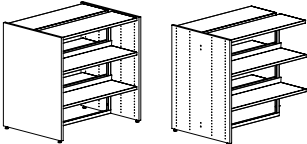
	Module cm	Shelf depth cm	Starter bay Item no.	Add-on bay Item no.
	75	25	BB78200727222245	BB78201727222245
	75	30	BB78200737222245	BB78201737222245
	75	40	BB78200747222245	BB78201747222245
	90	25	BB78200729222245	BB78201729222245
	90	30	BB78200739222245	BB78201739222245
	90	40	BB78200749222245	BB78201749222245
	100	25	BB78200721222245	BB78201721222245
	100	30	BB78200731222245	BB78201731222245
	100	40	BB78200741222245	BB78201741222245

Height 122 cm (3 shelves + top shelf on each side)

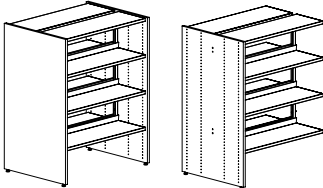
	Module cm	Shelf depth cm	Starter bay Item no.	Add-on bay Item no.
	75	25	BB78200227223245	BB78201227223245
	75	30	BB78200237223245	BB78201237223245
	75	40	BB78200247223245	BB78201247223245
	90	25	BB78200229223245	BB78201229223245
	90	30	BB78200239223245	BB78201239223245
	90	40	BB78200249223245	BB78201249223245
	100	25	BB78200221223245	BB78201221223245
	100	30	BB78200231223245	BB78201231223245
	100	40	BB78200241223245	BB78201241223245

Height 152 cm (4 shelves + top shelf on each side)

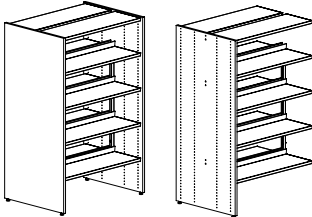
	Module cm	Shelf depth cm	Starter bay Item no.	Add-on bay Item no.
	75	25	BB78200527224245	BB78201527224245
	75	30	BB78200537224245	BB78201537224245
	75	40	BB78200547224245	BB78201547224245
	90	25	BB78200529224245	BB78201529224245
	90	30	BB78200539224245	BB78201539224245
	90	40	BB78200549224245	BB78201549224245
	100	25	BB78200521224245	BB78201521224245
	100	30	BB78200531224245	BB78201531224245
	100	40	BB78200541224245	BB78201541224245

Height 182 cm (5 shelves + top shelf on each side)

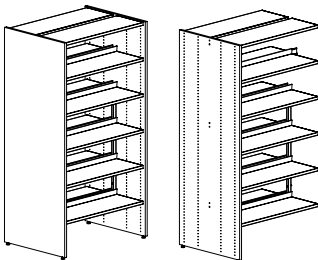
	Module cm	Shelf depth cm	Starter bay Item no.	Add-on bay Item no.
	75	25	BB78200827225245	BB78201827225245
	75	30	BB78200837225245	BB78201837225245
	75	40	BB78200847225245	BB78201847225245
	90	25	BB78200829225245	BB78201829225245
	90	30	BB78200839225245	BB78201839225245
	90	40	BB78200849225245	BB78201849225245
	100	25	BB78200821225245	BB78201821225245
	100	30	BB78200831225245	BB78201831225245
	100	40	BB78200841225245	BB78201841225245

SLIMLINE SHELVING SYSTEM

DOUBLE-SIDED - WITH SHELVES

Complete shelving system with panels, metal frame, steel shelves with acrylic backedge, steel top shelf without backedge, brackets, fittings and wall securement. Number of shelves are calculated for optimal shelf spacing for fiction.

Height 212 cm (6 shelves + top shelf on each side)

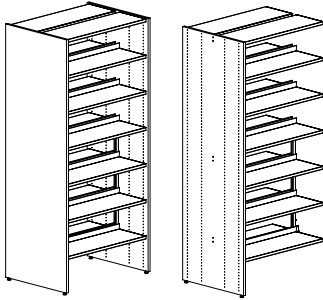

Module cm	Shelf depth cm	Starter bay Item no.	Add-on bay Item no.
75	25	BB78200127226245	BB78201127226245
75	30	BB78200137226245	BB78201137226245
75	40	BB78200147226245	BB78201147226245
90	25	BB78200129226245	BB78201129226245
90	30	BB78200139226245	BB78201139226245
90	40	BB78200149226245	BB78201149226245
100	25	BB78200121226245	BB78201121226245
100	30	BB78200131226245	BB78201131226245
100	40	BB78200141226245	BB78201141226245

SLIMLINE SHELVING SYSTEM

END PANEL BAYS - WITH SHELVES

Complete shelving bay with wooden panels, wooden back panel, wooden shelves, wooden top shelf and fittings. Place the end panel bay against a 25/25 (53.3 cm) or 30/30 (63.3 cm) double-sided end panel.

Height 122 cm (3 shelves + top shelf)

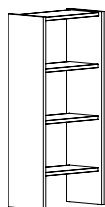

Depth of shelving system - cm

25/25
30/30

Shelf depth cm

25
25

Item no.

BB78210228
BB78210229

Height 152 cm (4 shelves + top shelf)



Depth of shelving system - cm

25/25
30/30

Shelf depth cm

25
25

Item no.

BB78210528
BB78210529

Height 182 cm (5 shelves + top shelf)



Depth of shelving system - cm

25/25
30/30

Shelf depth cm

25
25

Item no.

BB78210828
BB78210829

Height 212 cm (6 shelves + top shelf)

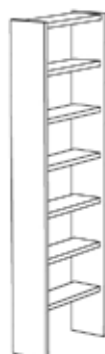

Depth of shelving system - cm

25/25
30/30

Shelf depth cm

25
25

Item no.

BB78210128
BB78210129

SLIMLINE SHELVING SYSTEM

ACCESSORIES FOR END PANEL BAYS

Clear acrylic sloping shelf incl. fittings



Bay cm

53
63

Item no.

B7840358
B7840359

Top wooden shelf incl. fittings

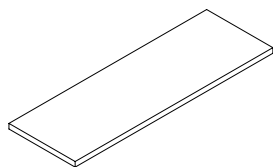

Bay cm

53
63

Item no.

B7840288
B7840289

Wooden shelf incl. fittings

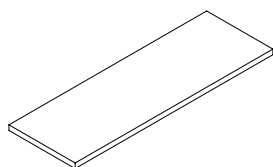

Bay cm

53
63

Item no.

B7840308
B7840309

Bottom wooden shelf incl. fittings

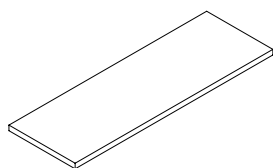

Bay cm

53
63

Item no.

B7840328
B7840329

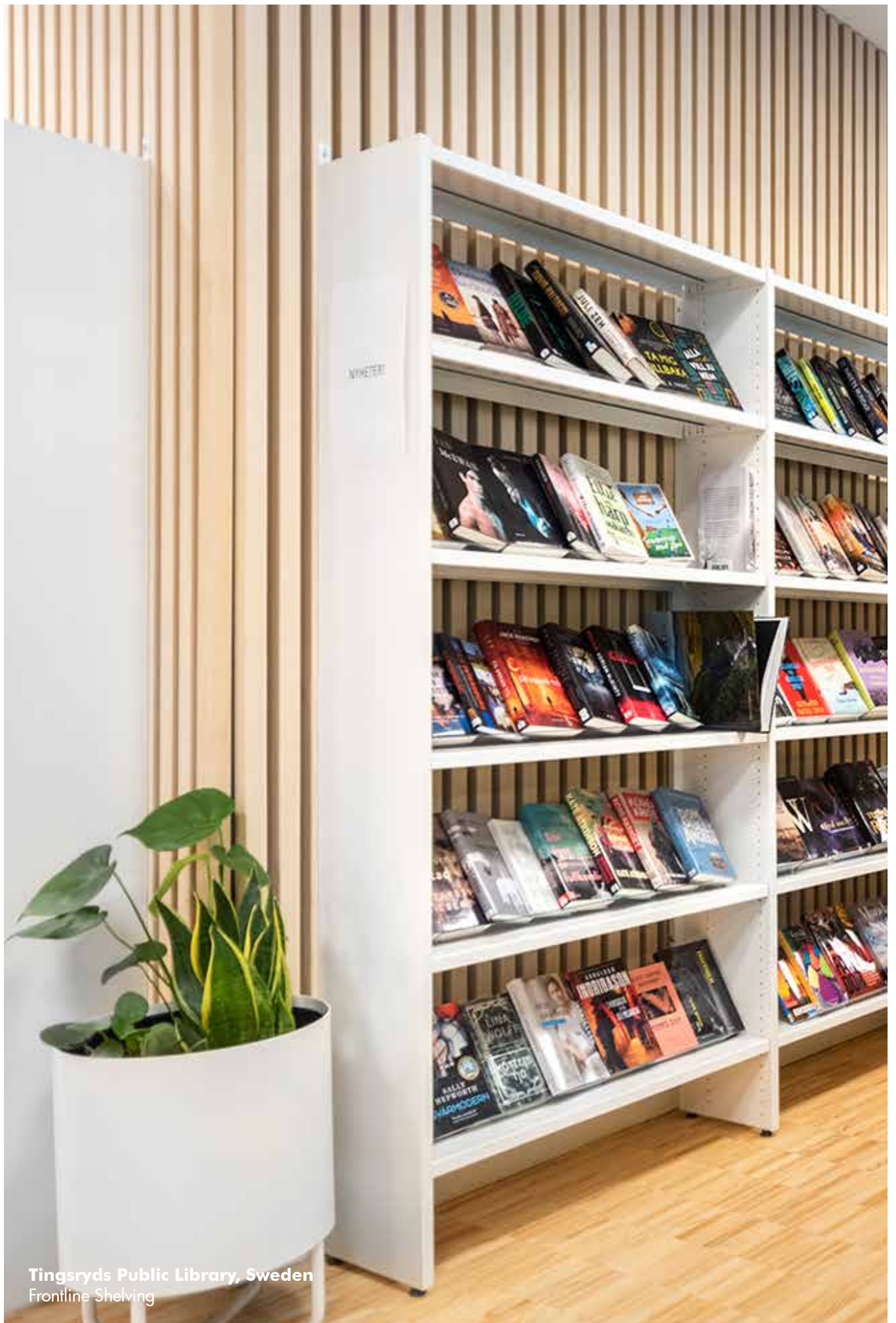

Tingsryds Public Library, Sweden
Frontline Shelving

FRONTLINE SHELVING SYSTEM (FSC)

The following pages will show 3 basic configurations of the Frontline Shelving System with either 22 or 38 mm thick panels:
 Frontline with 22 mm panels and no shelves.
 Frontline with 22 mm panels and x pcs. of steel shelves.
 Frontline with 38 mm panels, 38 mm top and bottom shelf and x pcs. of steel shelves.



The Frontline end panel has a 4 mm flat front edge of solid wood. The distance between the front edge of the end panel and the front edge of the shelf is 5 mm.

Standard Frontline configurations are delivered in light steamed beech veneer no. 55 and birch veneer no. 69. They can also be delivered in painted MDF in any NCS or RAL colour upon request (see Design Options page 7-9).

HEIGHTS

Frontline 22 shelving is available in 5 heights; 92, 122, 152, 182 and 212 cm and Frontline 38 is available in 4 heights; 122, 152, 182 and 212 cm. Heights include adjustable feet (max. 2 cm). The shelves are adjustable in 2.5 cm increments.

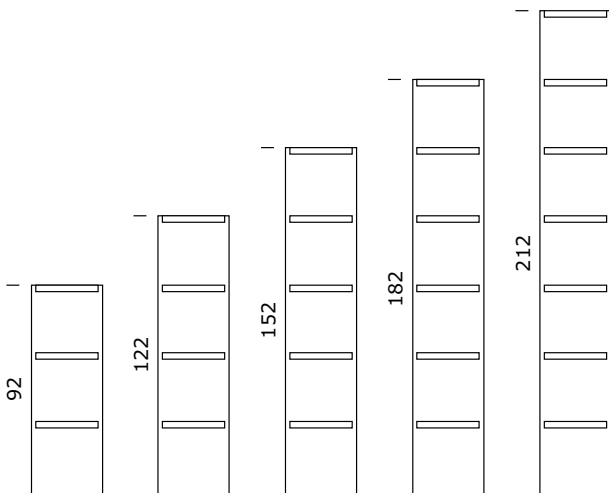

WIDTHS

The bays are available in 75, 90 and 100 cm modules and as starter and add-on bays. A starter bay has two outside panels while an add-on bay has one intermediate panel.

Frontline 22

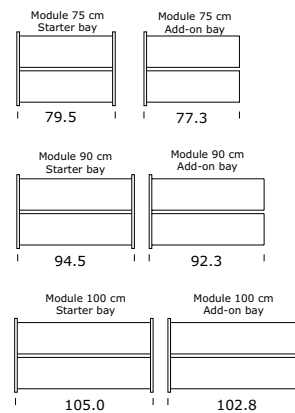

Frontline 38

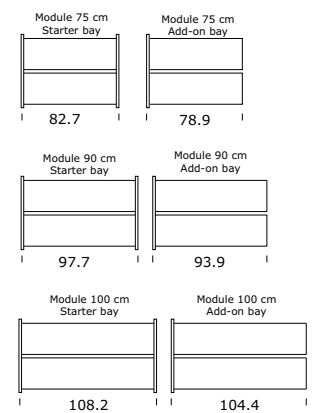

DEPTHS

The panels are available in 6 depths:
 28.7 cm for 25 cm deep shelves
 33.7 cm for 30 cm deep shelves
 43.7 cm for 40 cm deep shelves
 54.7 cm for 2 x 25 cm deep shelves
 64.7 cm for 2 x 30 cm deep shelves
 84.7 cm for 2 x 40 cm deep shelves

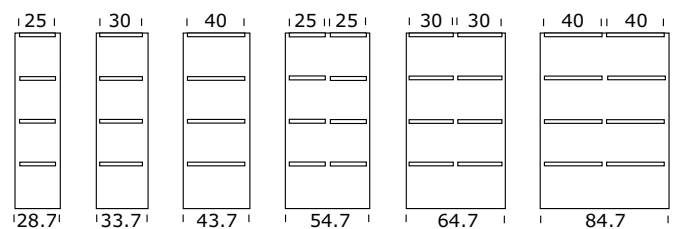

FRONTLINE SHELVING SYSTEM (FSC)

22 MM SINGLE-SIDED - WITHOUT SHELVES

Shelving system with 22 mm wooden panels, metal frame and wall securement. For shelves and functions see from page 56.

Height 92 cm

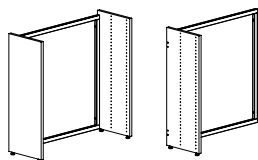

Module cm	Shelf depth cm	Starter bay Item no.	Add-on bay Item no.
75	25	BB783027271100451	BB783037271100451
75	30	BB783027371100451	BB783037371100451
75	40	BB783027471100451	BB783037471100451
90	25	BB783027291100451	BB783037291100451
90	30	BB783027391100451	BB783037391100451
90	40	BB783027491100451	BB783037491100451
100	25	BB783027211100451	BB783037211100451
100	30	BB783027311100451	BB783037311100451
100	40	BB783027411100451	BB783037411100451

Height 122 cm

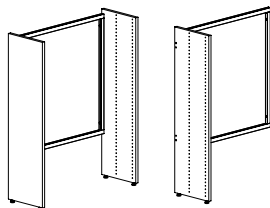

Module cm	Shelf depth cm	Starter bay Item no.	Add-on bay Item no.
75	25	BB783022271100451	BB783032271100451
75	30	BB783022371100451	BB783032371100451
75	40	BB783022471100451	BB783032471100451
90	25	BB783022291100451	BB783032291100451
90	30	BB783022391100451	BB783032391100451
90	40	BB783022491100451	BB783032491100451
100	25	BB783022211100451	BB783032211100451
100	30	BB783022311100451	BB783032311100451
100	40	BB783022411100451	BB783032411100451

Height 152 cm

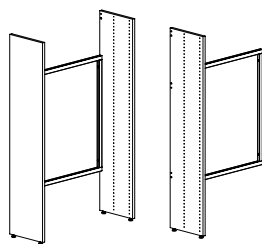

Module cm	Shelf depth cm	Starter bay Item no.	Add-on bay Item no.
75	25	BB783025271100451	BB783035271100451
75	30	BB783025371100451	BB783035371100451
75	40	BB783025471100451	BB783035471100451
90	25	BB783025291100451	BB783035291100451
90	30	BB783025391100451	BB783035391100451
90	40	BB783025491100451	BB783035491100451
100	25	BB783025211100451	BB783035211100451
100	30	BB783025311100451	BB783035311100451
100	40	BB783025411100451	BB783035411100451

Height 182 cm

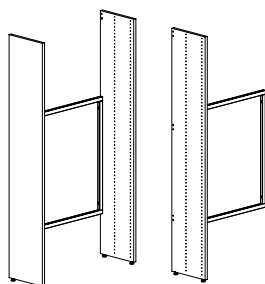

Module cm	Shelf depth cm	Starter bay Item no.	Add-on bay Item no.
75	25	BB783028271100451	BB783038271100451
75	30	BB783028371100451	BB783038371100451
75	40	BB783028471100451	BB783038471100451
90	25	BB783028291100451	BB783038291100451
90	30	BB783028391100451	BB783038391100451
90	40	BB783028491100451	BB783038491100451
100	25	BB783028211100451	BB783038211100451
100	30	BB783028311100451	BB783038311100451
100	40	BB783028411100451	BB783038411100451

FRONTLINE SHELVING SYSTEM (FSC)

22 MM SINGLE-SIDED - WITHOUT SHELVES

Shelving system with 22 mm wooden panels, metal frame and wall securement. For shelves and functions see from page 56.

Height 212 cm

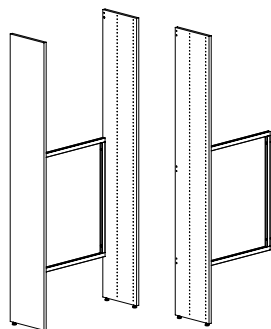

Module cm	Shelf depth cm	Starter bay Item no.	Add-on bay Item no.
75	25	BB783021271100451	BB783031271100451
75	30	BB783021371100451	BB783031371100451
75	40	BB783021471100451	BB783031471100451
90	25	BB783021291100451	BB783031291100451
90	30	BB783021391100451	BB783031391100451
90	40	BB783021491100451	BB783031491100451
100	25	BB783021211100451	BB783031211100451
100	30	BB783021311100451	BB783031311100451
100	40	BB783021411100451	BB783031411100451

Crossbar

Recommended for use with shelving systems without shelves with heights of 152 cm or more for stabilization. 1 per section. Available with holes for signage.



Module cm	Without/with holes	Starter bay Item no.	Add-on bay Item no.
75	Without	B7822187001	B7822187002
75	With	B7822187011	B7822187012
90	Without	B7822189001	B7822189002
90	With	B7822189011	B7822189012
100	Without	B7822181001	B7822181002
100	With	B7822181011	B7822181012

FRONTLINE SHELVING SYSTEM (FSC)

22 MM DOUBLE-SIDED - WITHOUT SHELVES

Shelving system with 22 mm wooden panels, metal frame and wall securement. For shelves and functions see from page 54.

Height 92 cm

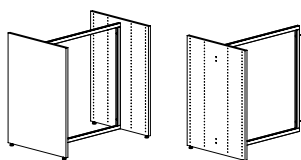

Module cm	Shelf depth cm	Starter bay Item no.	Add-on bay Item no.
75	25	BB783027272100451	BB783037272100451
75	30	BB783027372100451	BB783037372100451
75	40	BB783027472100451	BB783037472100451
90	25	BB783027292100451	BB783037292100451
90	30	BB783027392100451	BB783037392100451
90	40	BB783027492100451	BB783037492100451
100	25	BB783027212100451	BB783037212100451
100	30	BB783027312100451	BB783037312100451
100	40	BB783027412100451	BB783037412100451

Height 122 cm

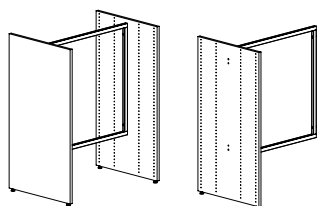

Module cm	Shelf depth cm	Starter bay Item no.	Add-on bay Item no.
75	25	BB783022272100451	BB783032272100451
75	30	BB783022372100451	BB783032372100451
75	40	BB783022472100451	BB783032472100451
90	25	BB783022292100451	BB783032292100451
90	30	BB783022392100451	BB783032392100451
90	40	BB783022492100451	BB783032492100451
100	25	BB783022212100451	BB783032212100451
100	30	BB783022312100451	BB783032312100451
100	40	BB783022412100451	BB783032412100451

Height 152 cm

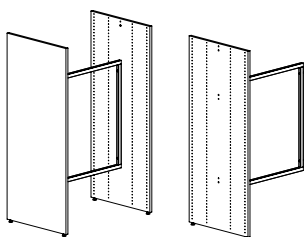

Module cm	Shelf depth cm	Starter bay Item no.	Add-on bay Item no.
75	25	BB783025272100451	BB783035272100451
75	30	BB783025372100451	BB783035372100451
75	40	BB783025472100451	BB783035472100451
90	25	BB783025292100451	BB783035292100451
90	30	BB783025392100451	BB783035392100451
90	40	BB783025492100451	BB783035492100451
100	25	BB783025212100451	BB783035212100451
100	30	BB783025312100451	BB783035312100451
100	40	BB783025412100451	BB783035412100451

Height 182 cm

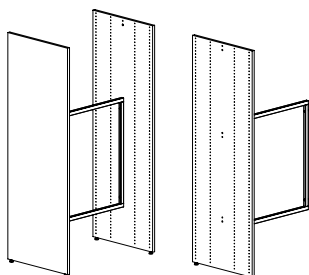

Module cm	Shelf depth cm	Starter bay Item no.	Add-on bay Item no.
75	25	BB783028272100451	BB783038272100451
75	30	BB783028372100451	BB783038372100451
75	40	BB783028472100451	BB783038472100451
90	25	BB783028292100451	BB783038292100451
90	30	BB783028392100451	BB783038392100451
90	40	BB783028492100451	BB783038492100451
100	25	BB783028212100451	BB783038212100451
100	30	BB783028312100451	BB783038312100451
100	40	BB783028412100451	BB783038412100451

FRONTLINE SHELVING SYSTEM (FSC)

22 MM DOUBLE-SIDED - WITHOUT SHELVES

Shelving system with 22 mm wooden panels, metal frame and wall securement. For shelves and functions see from page 54.

Height 212 cm

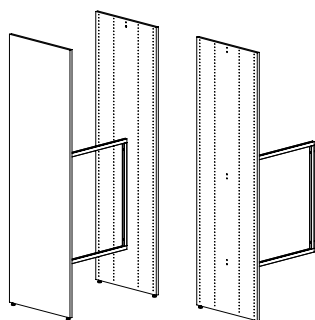

Module cm	Shelf depth cm	Starter bay Item no.	Add-on bay Item no.
75	25	BB783021272100451	BB783031272100451
75	30	BB783021372100451	BB783031372100451
75	40	BB783021472100451	BB783031472100451
90	25	BB783021292100451	BB783031292100451
90	30	BB783021392100451	BB783031392100451
90	40	BB783021492100451	BB783031492100451
100	25	BB783021212100451	BB783031212100451
100	30	BB783021312100451	BB783031312100451
100	40	BB783021412100451	BB783031412100451

Crossbar

Recommended for use with shelving systems without shelves with heights of 152 cm or more for stabilization. 1 per section. Available with holes for signage.



Module cm	Without/with holes	Starter bay Item no.	Add-on bay Item no.
75	Without	B7822187001	B7822187002
75	With	B7822187011	B7822187012
90	Without	B7822189001	B7822189002
90	With	B7822189011	B7822189012
100	Without	B7822181001	B7822181002
100	With	B7822181011	B7822181012

FRONTLINE SHELVING SYSTEM (FSC)

22 MM SINGLE-SIDED - WITH SHELVES

Complete shelving system with 22 mm wooden panels, metal frame, steel shelves with steel backedge, steel top shelf without backedge, brackets, fittings and wall securement. Number of shelves are calculated for optimal shelf spacing for fiction.

Height 92 cm (2 shelves + top shelf)

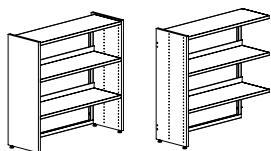

Module cm	Shelf depth cm	Starter bay Item no.	Add-on bay Item no.
75	25	BB783027271121451	BB783037271121451
75	30	BB783027371121451	BB783037371121451
75	40	BB783027471121451	BB783037471121451
90	25	BB783027291121451	BB783037291121451
90	30	BB783027391121451	BB783037391121451
90	40	BB783027491121451	BB783037491121451
100	25	BB783027211121451	BB783037211121451
100	30	BB783027311121451	BB783037311121451
100	40	BB783027411121451	BB783037411121451

Height 122 cm (3 shelves + top shelf)

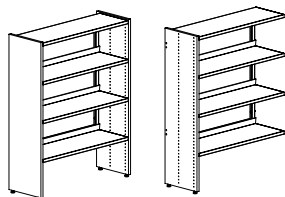

Module cm	Shelf depth cm	Starter bay Item no.	Add-on bay Item no.
75	25	BB783022271131451	BB783032271131451
75	30	BB783022371131451	BB783032371131451
75	40	BB783022471131451	BB783032471131451
90	25	BB783022291131451	BB783032291131451
90	30	BB783022391131451	BB783032391131451
90	40	BB783022491131451	BB783032491131451
100	25	BB783022211131451	BB783032211131451
100	30	BB783022311131451	BB783032311131451
100	40	BB783022411131451	BB783032411131451

Height 152 cm (4 shelves + top shelf)

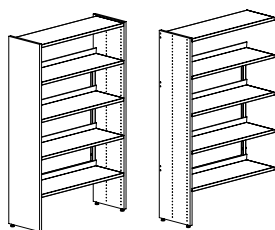

Module cm	Shelf depth cm	Starter bay Item no.	Add-on bay Item no.
75	25	BB783025271141451	BB783035271141451
75	30	BB783025371141451	BB783035371141451
75	40	BB783025471141451	BB783035471141451
90	25	BB783025291141451	BB783035291141451
90	30	BB783025391141451	BB783035391141451
90	40	BB783025491141451	BB783035491141451
100	25	BB783025211141451	BB783035211141451
100	30	BB783025311141451	BB783035311141451
100	40	BB783025411141451	BB783035411141451

Height 182 cm (5 shelves + top shelf)

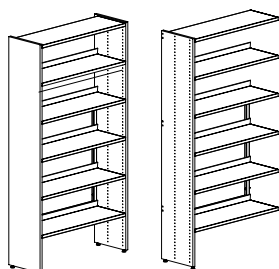

Module cm	Shelf depth cm	Starter bay Item no.	Add-on bay Item no.
75	25	BB783028271151451	BB783038271151451
75	30	BB783028371151451	BB783038371151451
75	40	BB783028471151451	BB783038471151451
90	25	BB783028291151451	BB783038291151451
90	30	BB783028391151451	BB783038391151451
90	40	BB783028491151451	BB783038491151451
100	25	BB783028211151451	BB783038211151451
100	30	BB783028311151451	BB783038311151451
100	40	BB783028411151451	BB783038411151451

FRONTLINE SHELVING SYSTEM (FSC)

22 MM SINGLE-SIDED - WITH SHELVES

Complete shelving system with 22 mm wooden panels, metal frame, steel shelves with steel backedge, steel top shelf without backedge, brackets, fittings and wall securement. Number of shelves are calculated for optimal shelf spacing for fiction.

Height 212 cm (6 shelves + top shelf)

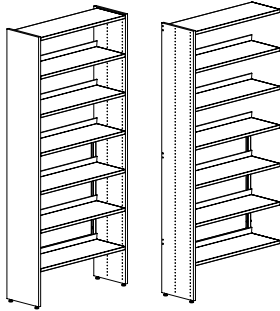

Module cm	Shelf depth cm	Starter bay Item no.	Add-on bay Item no.
75	25	BB783021271161451	BB783031271161451
75	30	BB783021371161451	BB783031371161451
75	40	BB783021471161451	BB783031471161451
90	25	BB783021291161451	BB783031291161451
90	30	BB783021391161451	BB783031391161451
90	40	BB783021491161451	BB783031491161451
100	25	BB783021211161451	BB783031211161451
100	30	BB783021311161451	BB783031311161451
100	40	BB783021411161451	BB783031411161451

FRONTLINE SHELVING SYSTEM (FSC)

22 MM DOUBLE-SIDED - WITH SHELVES

Complete shelving system with 22 mm wooden panels, metal frame, steel shelves with steel backedge, steel top shelf without backedge, brackets, fittings and wall securement. Number of shelves are calculated for optimal shelf spacing for fiction.

Height 92 cm (2 shelves + top shelf on each side)

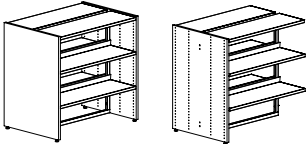
	Module cm	Shelf depth cm	Starter bay Item no.	Add-on bay Item no.
	75	25	BB783027272121451	BB783037272121451
	75	30	BB783027372121451	BB783037372121451
	75	40	BB783027472121451	BB783037472121451
	90	25	BB783027292121451	BB783037292121451
	90	30	BB783027392121451	BB783037392121451
	90	40	BB783027492121451	BB783037492121451
	100	25	BB783027212121451	BB783037212121451
	100	30	BB783027312121451	BB783037312121451
	100	40	BB783027412121451	BB783037412121451

Height 122 cm (3 shelves + top shelf on each side)

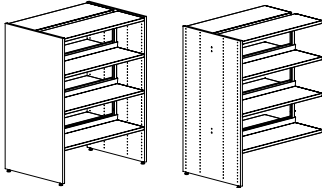
	Module cm	Shelf depth cm	Starter bay Item no.	Add-on bay Item no.
	75	25	BB783022272131451	BB783032272131451
	75	30	BB783022372131451	BB783032372131451
	75	40	BB783022472131451	BB783032472131451
	90	25	BB783022292131451	BB783032292131451
	90	30	BB783022392131451	BB783032392131451
	90	40	BB783022492131451	BB783032492131451
	100	25	BB783022212131451	BB783032212131451
	100	30	BB783022312131451	BB783032312131451
	100	40	BB783022412131451	BB783032412131451

Height 152 cm (4 shelves + top shelf on each side)

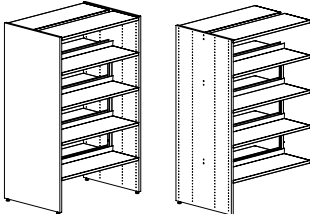
	Module cm	Shelf depth cm	Starter bay Item no.	Add-on bay Item no.
	75	25	BB783025272141451	BB783035272141451
	75	30	BB783025372141451	BB783035372141451
	75	40	BB783025472141451	BB783035472141451
	90	25	BB783025292141451	BB783035292141451
	90	30	BB783025392141451	BB783035392141451
	90	40	BB783025492141451	BB783035492141451
	100	25	BB783025212141451	BB783035212141451
	100	30	BB783025312141451	BB783035312141451
	100	40	BB783025412141451	BB783035412141451

Height 182 cm (5 shelves + top shelf on each side)

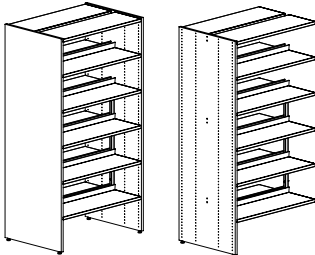
	Module cm	Shelf depth cm	Starter bay Item no.	Add-on bay Item no.
	75	25	BB783028272151451	BB783038272151451
	75	30	BB783028372151451	BB783038372151451
	75	40	BB783028472151451	BB783038472151451
	90	25	BB783028292151451	BB783038292151451
	90	30	BB783028392151451	BB783038392151451
	90	40	BB783028492151451	BB783038492151451
	100	25	BB783028212151451	BB783038212151451
	100	30	BB783028312151451	BB783038312151451
	100	40	BB783028412151451	BB783038412151451

FRONTLINE SHELVING SYSTEM (FSC)

22 MM DOUBLE-SIDED - WITH SHELVES

Complete shelving system with 22 mm wooden panels, metal frame, steel shelves with steel backedge, steel top shelf without backedge, brackets, fittings and wall securement. Number of shelves are calculated for optimal shelf spacing for fiction.

Height 212 cm (6 shelves + top shelf on each side)

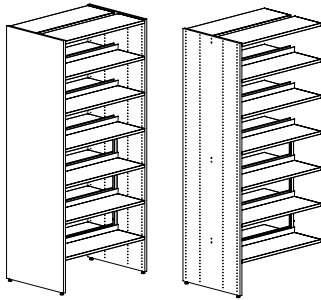

Module cm	Shelf depth cm	Starter bay Item no.	Add-on bay Item no.
75	25	BB783021272161451	BB783031272161451
75	30	BB783021372161451	BB783031372161451
75	40	BB783021472161451	BB783031472161451
90	25	BB783021292161451	BB783031292161451
90	30	BB783021392161451	BB783031392161451
90	40	BB783021492161451	BB783031492161451
100	25	BB783021212161451	BB783031212161451
100	30	BB783021312161451	BB783031312161451
100	40	BB783021412161451	BB783031412161451

FRONTLINE SHELVING SYSTEM (FSC)

38 MM SINGLE-SIDED - WITH SHELVES

Complete shelving system with 38 mm panels, metal frame, steel shelves with steel backedge, 38 mm wooden top and bottom shelves, brackets, fittings and wall securement. Number of shelves are calculated for optimal shelf spacing for fiction.

Height 122 cm (3 shelves, 1 top and 1 bottom shelf)

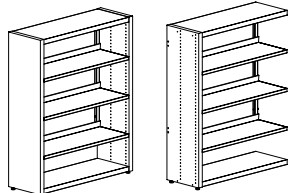
	Module cm	Shelf depth cm	Starter bay Item no.	Add-on bay Item no.
	75	25	BB7830822711311	BB7830922711311
	75	30	BB7830823711311	BB7830923711311
	75	40	BB7830824711311	BB7830924711311
	90	25	BB7830822911311	BB7830922911311
	90	30	BB7830823911311	BB7830923911311
	90	40	BB7830824911311	BB7830924911311
	100	25	BB7830822111311	BB7830922111311
	100	30	BB7830823111311	BB7830923111311
	100	40	BB7830824111311	BB7830924111311

Height 152 cm (4 shelves, 1 top and 1 bottom shelf)

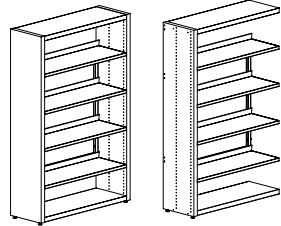
	Module cm	Shelf depth cm	Starter bay Item no.	Add-on bay Item no.
	75	25	BB7830852711411	BB7830952711411
	75	30	BB7830853711411	BB7830953711411
	75	40	BB7830854711411	BB7830954711411
	90	25	BB7830852911411	BB7830952911411
	90	30	BB7830853911411	BB7830953911411
	90	40	BB7830854911411	BB7830954911411
	100	25	BB7830852111411	BB7830952111411
	100	30	BB7830853111411	BB7830953111411
	100	40	BB7830854111411	BB7830954111411

Height 182 cm (5 shelves, 1 top and 1 bottom shelf)

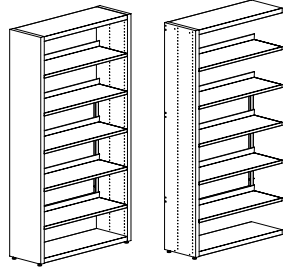
	Module cm	Shelf depth cm	Starter bay Item no.	Add-on bay Item no.
	75	25	BB7830882711511	BB7830982711511
	75	30	BB7830883711511	BB7830983711511
	75	40	BB7830884711511	BB7830984711511
	90	25	BB7830882911511	BB7830982911511
	90	30	BB7830883911511	BB7830983911511
	90	40	BB7830884911511	BB7830984911511
	100	25	BB7830882111511	BB7830982111511
	100	30	BB7830883111511	BB7830983111511
	100	40	BB7830884111511	BB7830984111511

Height 212 cm (6 shelves, 1 top and 1 bottom shelf)

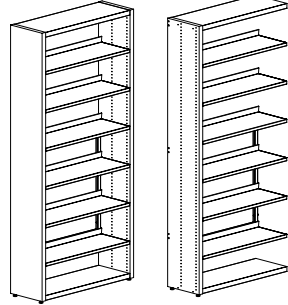
	Module cm	Shelf depth cm	Starter bay Item no.	Add-on bay Item no.
	75	25	BB7830812711611	BB7830912711611
	75	30	BB7830813711611	BB7830913711611
	75	40	BB7830814711611	BB7830914711611
	90	25	BB7830812911611	BB7830912911611
	90	30	BB7830813911611	BB7830913911611
	90	40	BB7830814911611	BB7830914911611
	100	25	BB7830812111611	BB7830912111611
	100	30	BB7830813111611	BB7830913111611
	100	40	BB7830814111611	BB7830914111611

FRONTLINE SHELVING SYSTEM (FSC)

38 MM DOUBLE-SIDED - WITH SHELVES

Complete shelving system with 38 mm panels, metal frame, steel shelves with steel backedge, 38 mm wooden top and bottom shelves, brackets, fittings and wall securement. Number of shelves are calculated for optimal shelf spacing for fiction.

Height 122 cm (6 shelves, 1 top and 1 bottom shelf in full depth)

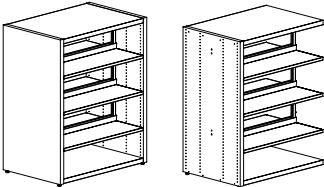
	Module cm	Shelf depth cm	Starter bay Item no.	Add-on bay Item no.
	75	25	BB7830822721311	BB7830922721311
	75	30	BB7830823721311	BB7830923721311
	75	40	BB7830824721311	BB7830924721311
	90	25	BB7830822921311	BB7830922921311
	90	30	BB7830823921311	BB7830923921311
	90	40	BB7830824921311	BB7830924921311
	100	25	BB7830822121311	BB7830922121311
	100	30	BB7830823121311	BB7830923121311
	100	40	BB7830824121311	BB7830924121311

Height 152 cm (8 shelves, 1 top and 1 bottom shelf in full depth)

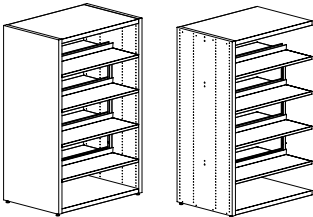
	Module cm	Shelf depth cm	Starter bay Item no.	Add-on bay Item no.
	75	25	BB7830852721411	BB7830952721411
	75	30	BB7830853721411	BB7830953721411
	75	40	BB7830854721411	BB7830954721411
	90	25	BB7830852921411	BB7830952921411
	90	30	BB7830853921411	BB7830953921411
	90	40	BB7830854921411	BB7830954921411
	100	25	BB7830852121411	BB7830952121411
	100	30	BB7830853121411	BB7830953121411
	100	40	BB7830854121411	BB7830954121411

Height 182 cm (10 shelves, 1 top and 1 bottom shelf in full depth)

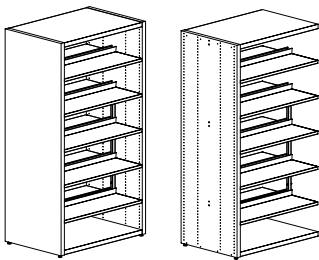
	Module cm	Shelf depth cm	Starter bay Item no.	Add-on bay Item no.
	75	25	BB7830882721511	BB7830982721511
	75	30	BB7830883721511	BB7830983721511
	75	40	BB7830884721511	BB7830984721511
	90	25	BB7830882921511	BB7830982921511
	90	30	BB7830883921511	BB7830983921511
	90	40	BB7830884921511	BB7830984921511
	100	25	BB7830882121511	BB7830982121511
	100	30	BB7830883121511	BB7830983121511
	100	40	BB7830884121511	BB7830984121511

Height 212 cm (12 shelves, 1 top and 1 bottom shelf in full depth)

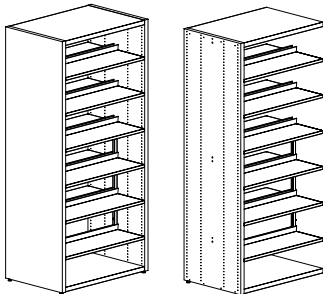
	Module cm	Shelf depth cm	Starter bay Item no.	Add-on bay Item no.
	75	25	BB7830812721611	BB7830912721611
	75	30	BB7830813721611	BB7830913721611
	75	40	BB7830814721611	BB7830914721611
	90	25	BB7830812921611	BB7830912921611
	90	30	BB7830813921611	BB7830913921611
	90	40	BB7830814921611	BB7830914921611
	100	25	BB7830812121611	BB7830912121611
	100	30	BB7830813121611	BB7830913121611
	100	40	BB7830814121611	BB7830914121611

FRONTLINE SHELVING SYSTEM (FSC)

END PANEL BAYS - WITH SHELVES

Complete end panel bay with wooden panels, wooden back panel, wooden shelves, wooden top shelf and fittings. Place the end panel shelving unit against a 25/25 (54.4 cm) or 30/30 (64.4 cm) double-sided end panel.

Height 122 cm (3 shelves + top shelf)

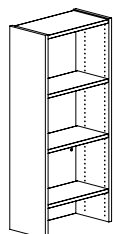

Depth of shelving system - cm	Shelf depth cm	Item no.
25/25	25	BB78311226
30/30	25	BB78311227

Height 152 cm (4 shelves + top shelf)

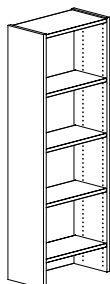

Depth of shelving system - cm	Shelf depth cm	Item no.
25/25	25	BB78311526
30/30	25	BB78311527

Height 182 cm (5 shelves + top shelf)

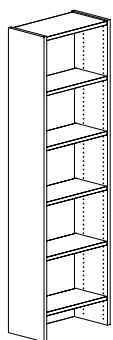

Depth of shelving system - cm	Shelf depth cm	Item no.
25/25	25	BB78311826
30/30	25	BB78311827

Height 212 cm (6 shelves + top shelf)

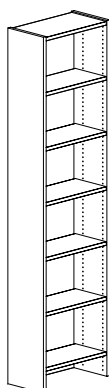

Depth of shelving system - cm	Shelf depth cm	Item no.
25/25	25	BB78311126
30/30	25	BB78311127

FRONTLINE SHELVING SYSTEM (FSC)

ACCESSORIES FOR END PANEL BAYS

Clear acrylic sloping shelf incl. fittings



Bay cm

55
65

Item no.

B7840356
B7840357

Top wooden shelf incl. fittings

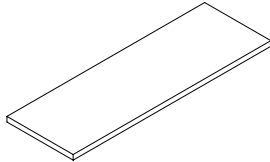

Bay cm

55
65

Item no.

B7840286
B7840287

Wooden shelf incl. fittings

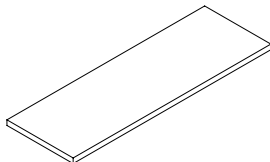

Bay cm

55
65

Item no.

B7840306
B7840307

Bottom wooden shelf incl. fittings

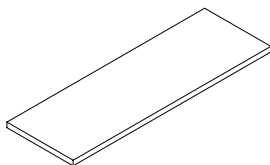

Bay cm

55
65

Item no.

B7840326
B7840327

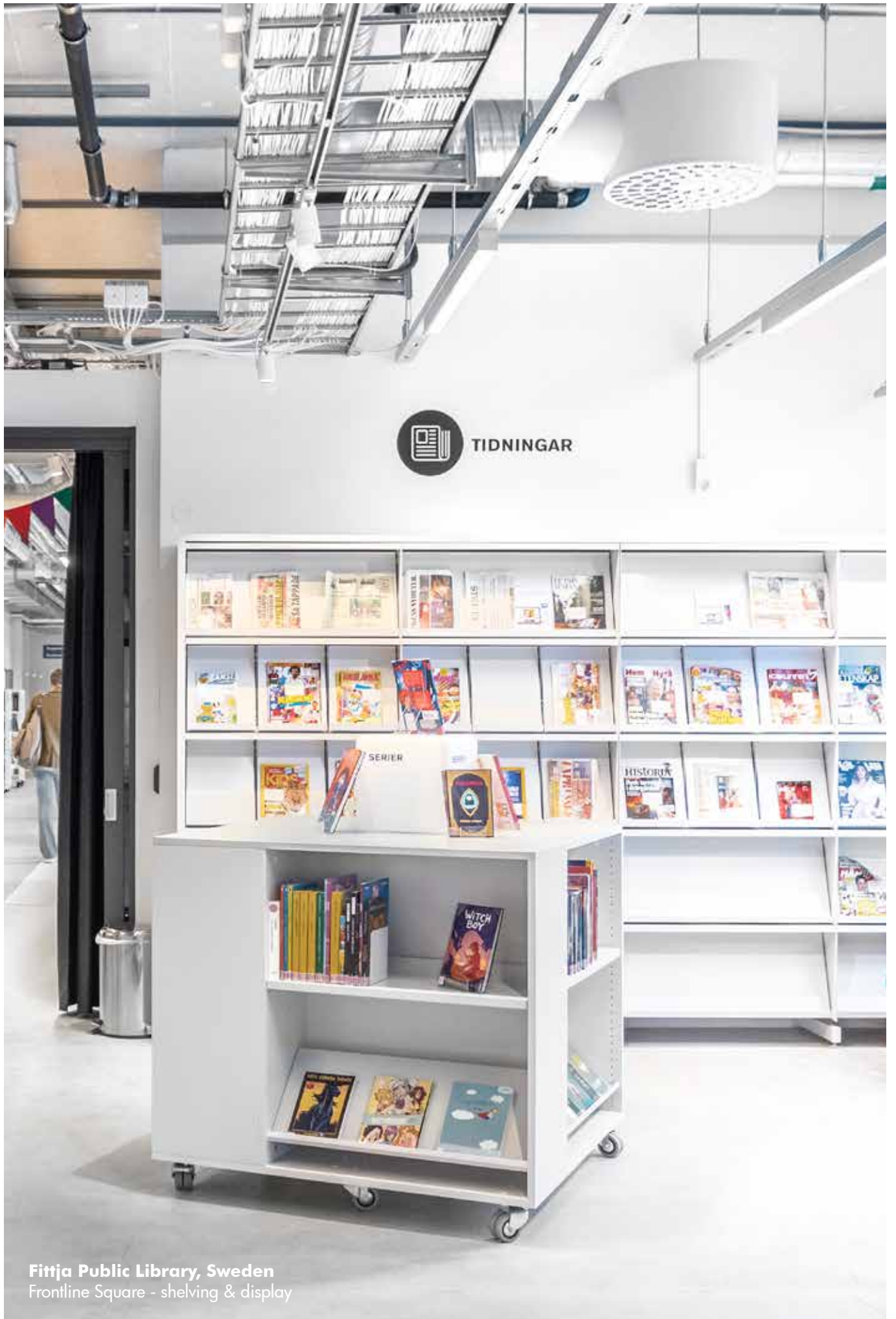

 TIDNINGAR

Fitja Public Library, Sweden
Frontline Square - shelving & display

FRONTLINE SQUARE (FSC)

The following pages will show basic configurations of Frontline Square - shelving and display.

Frontline Square can be used in different environments for display, storage, exhibition and more. The top plate which is also available in laminate can also serve as a worktable, display or a play area.



Configurations are available both with and without shelves. All standard models are equipped with 8 castors, so you can move the unit to the position you want. The panels are ideal for graphics and signage which can emphasize a theme, a classification or general information. This combined with colour can create the atmosphere you want to tempt your visitors to borrow books or just to enjoy their stay.

Frontline Square configurations are delivered as standard in MDF in any NCS or RAL colour, light steamed beech veneer no. 55 and birch veneer no. 69 (see Design Options page 7-9).

HEIGHTS

The shelving system comes in 4 heights (with castors Ø8 cm); 92 (105.2), 122 (135.2), 152 (165.2) and 182 (195.2) cm. The shelves are adjustable in 2.5 cm increments.

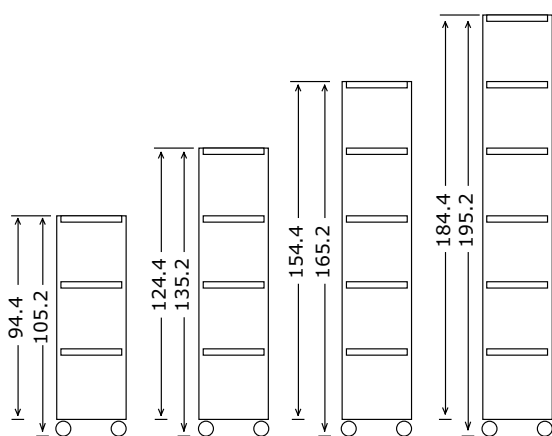

WIDTHS

The shelving system comes with two shelf widths; 75 and 90 cm. The total width of the unit depends on your choice of both shelf width and shelf depth; 108.2, 113.2, 123.2 and 128.2 cm.

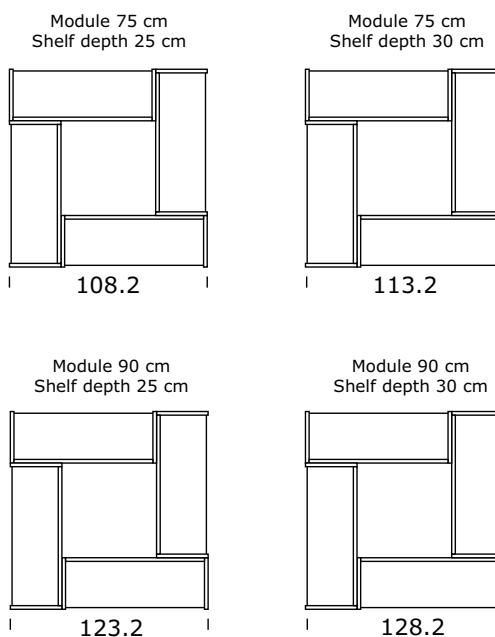

DEPTHS

The panels come in 2 depths;
29 cm for 25 cm deep shelves
34 cm for 30 cm deep shelves

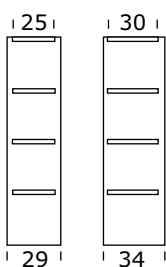

FRONTLINE SQUARE (FSC)

CONFIGURATIONS WITHOUT SHELVES - VENEER

Square shelving with end panels, back panels, top and bottom plate and fittings. Add shelves and functions of your choice, see from page 56. There are 8 castors in total (2 with brake). The maximum load is 600 kg. Available in veneer, painted or painted with laminated top.

Height 92 (105.2) cm - veneer

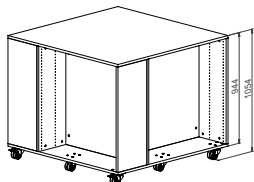

Type	Module cm	Shelf depth cm	Total width cm	Item no.
Veneer	75	25	108,2	BB784117272ZZZ1ZZZZZZZ00000
Veneer	75	30	113,2	BB784117372ZZZ1ZZZZZZZ00000
Veneer	90	25	123,2	BB784117292ZZZ1ZZZZZZZ00000
Veneer	90	30	128,2	BB784117392ZZZ1ZZZZZZZ00000

Height 122 (135.2) cm - veneer

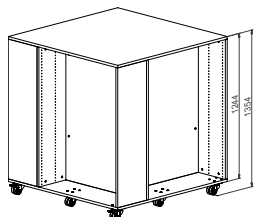

Type	Module cm	Shelf depth cm	Total width cm	Item no.
Veneer	75	25	108,2	BB784112272ZZZ1ZZZZZZZ00000
Veneer	75	30	113,2	BB784112372ZZZ1ZZZZZZZ00000
Veneer	90	25	123,2	BB784112292ZZZ1ZZZZZZZ00000
Veneer	90	30	128,2	BB784112392ZZZ1ZZZZZZZ00000

Height 152 (165.2) cm - veneer

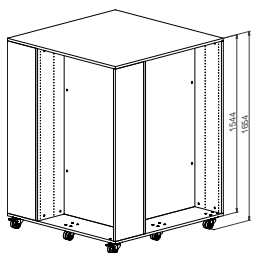

Type	Module cm	Shelf depth cm	Total width cm	Item no.
Veneer	75	25	108,2	BB784115272ZZZ1ZZZZZZZ00000
Veneer	75	30	113,2	BB784115372ZZZ1ZZZZZZZ00000
Veneer	90	25	123,2	BB784115292ZZZ1ZZZZZZZ00000
Veneer	90	30	128,2	BB784115392ZZZ1ZZZZZZZ00000

Height 182 (195.2) cm - veneer

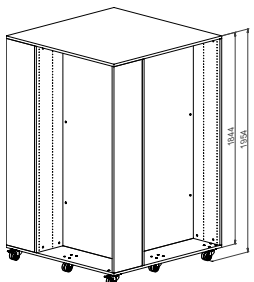

Type	Module cm	Shelf depth cm	Total width cm	Item no.
Veneer	75	25	108,2	BB784118272ZZZ1ZZZZZZZ00000
Veneer	75	30	113,2	BB784118372ZZZ1ZZZZZZZ00000
Veneer	90	25	123,2	BB784118292ZZZ1ZZZZZZZ00000
Veneer	90	30	128,2	BB784118392ZZZ1ZZZZZZZ00000

FRONTLINE SQUARE (FSC)

CONFIGURATIONS WITHOUT SHELVES - PAINTED

Square shelving with end panels, back panels, top and bottom plate and fittings. Add shelves and functions of your choice, see from page 56. There are 8 castors in total (2 with brake). The maximum load is 600 kg. Available in veneer, painted or painted with laminated top.

Height 92 (105.2) cm - painted / painted with laminated top

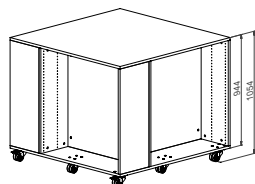

Type	Module cm	Shelf depth cm	Total width cm	Item no.
Painted	75	25	108,2	BB784117272ZZZ5ZZZZZZZ00000
Painted	75	30	113,2	BB784117372ZZZ5ZZZZZZZ00000
Painted	90	25	123,2	BB784117292ZZZ5ZZZZZZZ00000
Painted	90	30	128,2	BB784117392ZZZ5ZZZZZZZ00000
Laminated top	75	25	108,2	BB784117271BBB5ZZZZZZZ00000
Laminated top	75	30	113,2	BB784117371BBB5ZZZZZZZ00000
Laminated top	90	25	123,2	BB784117291BBB5ZZZZZZZ00000
Laminated top	90	30	128,2	BB784117391BBB5ZZZZZZZ00000

Height 122 (135.2) cm - painted / painted with laminated top

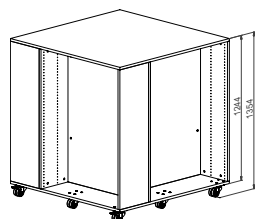

Type	Module cm	Shelf depth cm	Total width cm	Item no.
Painted	75	25	108,2	BB784112272ZZZ5ZZZZZZZ00000
Painted	75	30	113,2	BB784112372ZZZ5ZZZZZZZ00000
Painted	90	25	123,2	BB784112292ZZZ5ZZZZZZZ00000
Painted	90	30	128,2	BB784112392ZZZ5ZZZZZZZ00000
Laminated top	75	25	108,2	BB784112271BBB5ZZZZZZZ00000
Laminated top	75	30	113,2	BB784112371BBB5ZZZZZZZ00000
Laminated top	90	25	123,2	BB784112291BBB5ZZZZZZZ00000
Laminated top	90	30	128,2	BB784112391BBB5ZZZZZZZ00000

Height 152 (165.2) cm - painted/painted with laminated top

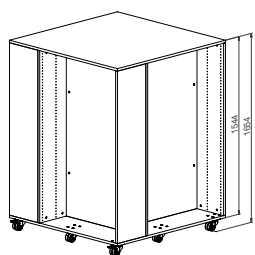

Type	Module cm	Shelf depth cm	Total width cm	Item no.
Painted	75	25	108,2	BB784115272ZZZ5ZZZZZZZ00000
Painted	75	30	113,2	BB784115372ZZZ5ZZZZZZZ00000
Painted	90	25	123,2	BB784115292ZZZ5ZZZZZZZ00000
Painted	90	30	128,2	BB784115392ZZZ5ZZZZZZZ00000
Laminated top	75	25	108,2	BB784115271BBB5ZZZZZZZ00000
Laminated top	75	30	113,2	BB784115371BBB5ZZZZZZZ00000
Laminated top	90	25	123,2	BB784115291BBB5ZZZZZZZ00000
Laminated top	90	30	128,2	BB784115391BBB5ZZZZZZZ00000

Height 182 (195.2) cm - painted / painted with laminated top

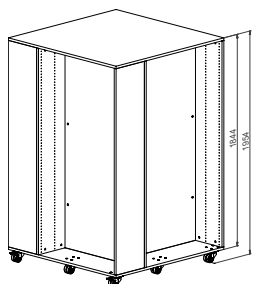

Type	Module cm	Shelf depth cm	Total width cm	Item no.
Painted	75	25	108,2	BB784118272ZZZ5ZZZZZZZ00000
Painted	75	30	113,2	BB784118372ZZZ5ZZZZZZZ00000
Painted	90	25	123,2	BB784118292ZZZ5ZZZZZZZ00000
Painted	90	30	128,2	BB784118392ZZZ5ZZZZZZZ00000
Laminated top	75	25	108,2	BB784118271BBB5ZZZZZZZ00000
Laminated top	75	30	113,2	BB784118371BBB5ZZZZZZZ00000
Laminated top	90	25	123,2	BB784118291BBB5ZZZZZZZ00000
Laminated top	90	30	128,2	BB784118391BBB5ZZZZZZZ00000

FRONTLINE SQUARE (FSC)

CONFIGURATIONS WITH SHELVES - VENEER

Complete square shelving with end panels, back panel, shelves, top and bottom plate, brackets and fittings. There are 8 castors in total (2 with brake). The maximum load is 600 kg. and the shelves are steel shelves with steel backedge. The number of shelves are calculated for optimal shelf spacing for fiction. Available in veneer, painted or painted with laminated top.

Height 92 (105.2) cm - 8 shelves, 2 on each side - veneer

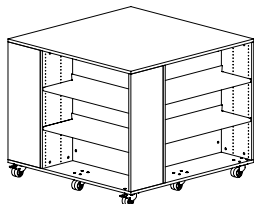

Type	Module cm	Shelf depth cm	Total width cm	Veneer Item no.
Veneer	75	25	108,2	BB784117272ZZZ1ZZZZZZZ10800
Veneer	75	30	113,2	BB784117372ZZZ1ZZZZZZZ10800
Veneer	90	25	123,2	BB784117292ZZZ1ZZZZZZZ10800
Veneer	90	30	128,2	BB784117392ZZZ1ZZZZZZZ10800

Height 122 (135.2) cm - 12 shelves, 3 on each side - veneer

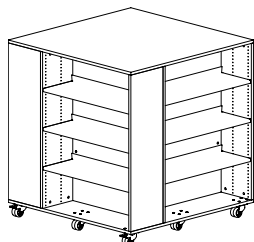

Type	Module cm	Shelf depth cm	Total width cm	Veneer Item no.
Veneer	75	25	108,2	BB784112272ZZZ1ZZZZZZZ11200
Veneer	75	30	113,2	BB784112372ZZZ1ZZZZZZZ11200
Veneer	90	25	123,2	BB784112292ZZZ1ZZZZZZZ11200
Veneer	90	30	128,2	BB784112392ZZZ1ZZZZZZZ11200

Height 152 (165.2) cm - 16 shelves, 4 on each side - veneer

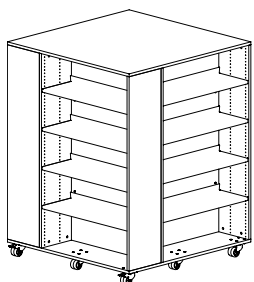

Type	Module cm	Shelf depth cm	Total width cm	Veneer Item no.
Veneer	75	25	108,2	BB784115272ZZZ1ZZZZZZZ11600
Veneer	75	30	113,2	BB784115372ZZZ1ZZZZZZZ11600
Veneer	90	25	123,2	BB784115292ZZZ1ZZZZZZZ11600
Veneer	90	30	128,2	BB784115392ZZZ1ZZZZZZZ11600

Height 182 (195.2) cm - 20 shelves, 5 on each side - veneer

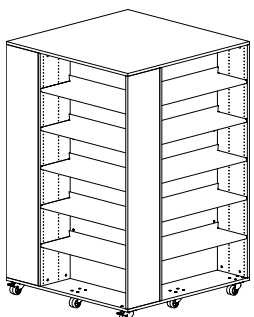

Type	Module cm	Shelf depth cm	Total width cm	Veneer Item no.
Veneer	75	25	108,2	BB784118272ZZZ1ZZZZZZZ12000
Veneer	75	30	113,2	BB784118372ZZZ1ZZZZZZZ12000
Veneer	90	25	123,2	BB784118292ZZZ1ZZZZZZZ12000
Veneer	90	30	128,2	BB784118392ZZZ1ZZZZZZZ12000

FRONTLINE SQUARE (FSC)

CONFIGURATIONS WITH SHELVES - PAINTED

Complete square shelving with end panels, back panel, shelves, top and bottom plate, brackets and fittings. There are 8 castors in total (2 with brake). The maximum load is 600 kg. and the shelves are steel shelves with steel backedge. The number of shelves are calculated for optimal shelf spacing for fiction. Available in veneer, painted or painted with laminated top.

Height 92 (105.2) cm - 8 shelves, 2 on each side - painted / painted with laminated top

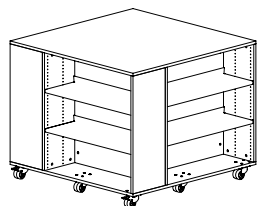

Type	Module cm	Shelf depth cm	Total width cm	Item no.
Painted	75	25	108,2	BB784117272ZZZ5ZZZZZZZ10800
Painted	75	30	113,2	BB784117372ZZZ5ZZZZZZZ10800
Painted	90	25	123,2	BB784117292ZZZ5ZZZZZZZ10800
Painted	90	30	128,2	BB784117392ZZZ5ZZZZZZZ10800
Laminated top	75	25	108,2	BB784117271BBB5ZZZZZZZ10800
Laminated top	75	30	113,2	BB784117371BBB5ZZZZZZZ10800
Laminated top	90	25	123,2	BB784117291BBB5ZZZZZZZ10800
Laminated top	90	30	128,2	BB784117391BBB5ZZZZZZZ10800

Height 122 (135.2) cm - 12 shelves, 3 on each side - painted / painted with laminated top

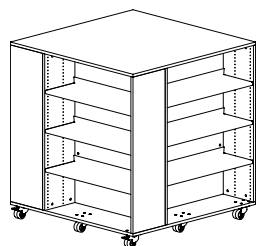

Type	Module cm	Shelf depth cm	Total width cm	Item no.
Painted	75	25	108,2	BB784112272ZZZ5ZZZZZZZ11200
Painted	75	30	113,2	BB784112372ZZZ5ZZZZZZZ11200
Painted	90	25	123,2	BB784112292ZZZ5ZZZZZZZ11200
Painted	90	30	128,2	BB784112392ZZZ5ZZZZZZZ11200
Laminated top	75	25	108,2	BB784112271BBB5ZZZZZZZ11200
Laminated top	75	30	113,2	BB784112371BBB5ZZZZZZZ11200
Laminated top	90	25	123,2	BB784112291BBB5ZZZZZZZ11200
Laminated top	90	30	128,2	BB784112391BBB5ZZZZZZZ11200

Height 152 (165.2) cm - 16 shelves, 4 on each side - painted / painted with laminated top

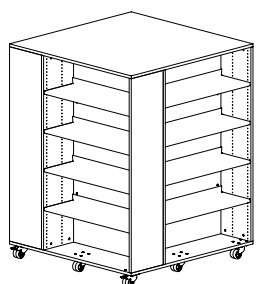

Type	Module cm	Shelf depth cm	Total width cm	Item no.
Painted	75	25	108,2	BB784115272ZZZ5ZZZZZZZ11600
Painted	75	30	113,2	BB784115372ZZZ5ZZZZZZZ11600
Painted	90	25	123,2	BB784115292ZZZ5ZZZZZZZ11600
Painted	90	30	128,2	BB784115392ZZZ5ZZZZZZZ11600
Laminated top	75	25	108,2	BB784115271BBB5ZZZZZZZ11600
Laminated top	75	30	113,2	BB784115371BBB5ZZZZZZZ11600
Laminated top	90	25	123,2	BB784115291BBB5ZZZZZZZ11600
Laminated top	90	30	128,2	BB784115391BBB5ZZZZZZZ11600

Height 182 (195.2) cm - 20 shelves, 5 on each side - painted / painted with laminated top

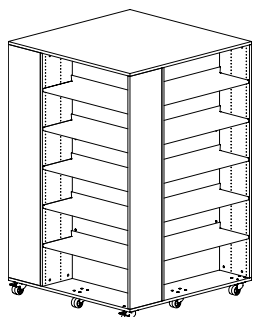

Type	Module cm	Shelf depth cm	Total width cm	Item no.
Painted	75	25	108,2	BB784118272ZZZ5ZZZZZZZ12000
Painted	75	30	113,2	BB784118372ZZZ5ZZZZZZZ12000
Painted	90	25	123,2	BB784118292ZZZ5ZZZZZZZ12000
Painted	90	30	128,2	BB784118392ZZZ5ZZZZZZZ12000
Laminated top	75	25	108,2	BB784118271BBB5ZZZZZZZ12000
Laminated top	75	30	113,2	BB784118291BBB5ZZZZZZZ12000
Laminated top	90	25	123,2	BB784118371BBB5ZZZZZZZ12000
Laminated top	90	30	128,2	BB784118391BBB5ZZZZZZZ12000



Dokk1 Public Library, Århus, Denmark
Ordrup Square

ORDRUP SQUARE

The following pages will show basic configurations of Ordrup Square.

Ordrup Square is a combined magazine display and storage unit on castors. It is based on Slimline upright panels with end panels and cabinet doors with acrylic display. Behind the cabinet doors with acrylic display are compartments providing A4 vertical storage boxes for older versions of the magazines. The end panel comes with a 4 mm flat front edge of solid wood. The top plate can also serve as a display or play area, depending on the height of the furniture.

All standard models are equipped with 8 castors, so you can move the unit to the position you want. The end panels are ideal for graphics and signage which can emphasize a theme, a classification or general information.

Ordrup Square configurations are delivered as standard in MDF in any NCS or RAL colour, light steamed beech veneer no. 55 and birch veneer no. 69 (see Design Options page 7-9).

HEIGHTS

The shelving system comes in 4 heights (with castors Ø7.5 cm); 92 (105.2), 122 (135.2), 152 (165.2) and 182 (195.2) cm.

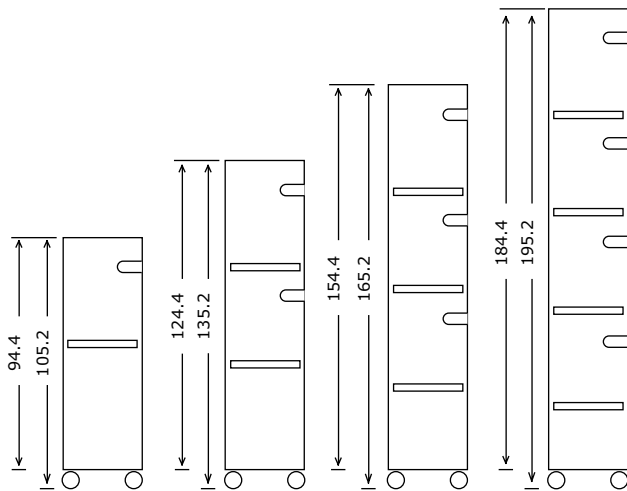

WIDTHS

The shelving system comes with 3 widths; 1, 2 or 3 columns. The total width of the unit depends on the amount of columns.

1 column

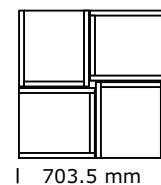

703.5 mm

2 columns

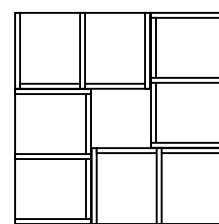

1027.5 mm

3 columns

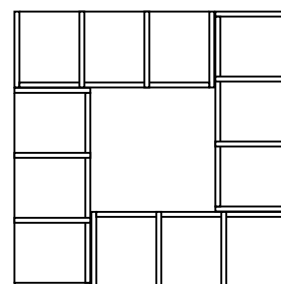

1351.5 mm

DEPTHS

The depth of the Ordrup Square is 36 cm.

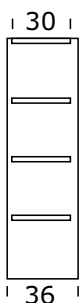

ORDRUP SQUARE

CONFIGURATIONS - VENEER

Complete square shelving with end panels, full back, top and bottom plate, doors with acrylic display and cabinet protection pads, shelves and fittings. There are 8 castors in total (2 with brake). The maximum load is 600 kg.

Height 92 (105.2 cm) - with 1 cupboard in height

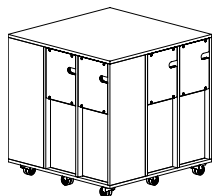

Type	Coloumns	Total width cm	Item no.
Veneer	1	703.5	BB78840711
Veneer	2	1027.5	BB78840721
Veneer	3	1351.5	BB78840731

Height 122 (135.2 cm) - with 2 cupboards in height

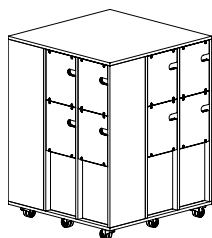

Type	Coloumns	Total width cm	Item no.
Veneer	1	703.5	BB78840211
Veneer	2	1027.5	BB78840221
Veneer	3	1351.5	BB78840231

Height 152 (165.2 cm) - with 3 cupboards in height

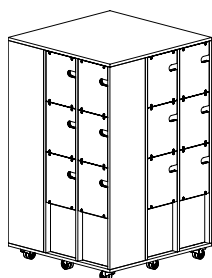

Type	Coloumns	Total width cm	Item no.
Veneer	1	703.5	BB78840511
Veneer	2	1027.5	BB78840521
Veneer	3	1351.5	BB78840531

Height 182 (195.2 cm) - with 4 cupboards in height

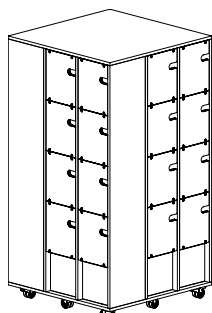

Type	Coloumns	Total width cm	Item no.
Veneer	-	-	-
Veneer	2	1027.5	BB78840821
Veneer	3	1351.5	BB78840831

ORDRUP SQUARE

CONFIGURATIONS - PAINTED

Complete square shelving with end panels, full back, top and bottom plate, doors with acrylic display and cabinet protection pads, shelves and fittings. There are 8 castors in total (2 with brake). The maximum load is 600 kg.

Height 92 (105.2 cm) - with 1 cupboard in height

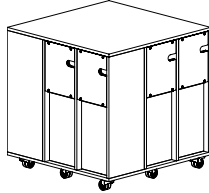

Type	Coloumns	Total width cm	Item no.
Painted	1	703.5	BB78840715
Painted	2	1027.5	BB78840725
Painted	3	1351.5	BB78840735

Height 122 (135.2 cm) - with 2 cupboards in height

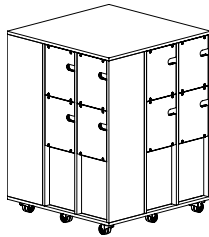

Type	Coloumns	Total width cm	Item no.
Painted	1	703.5	BB78840215
Painted	2	1027.5	BB78840225
Painted	3	1351.5	BB78840235

Height 152 (165.2 cm) - with 3 cupboards in height

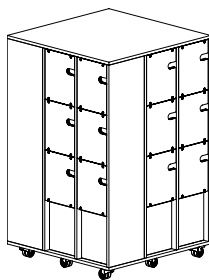

Type	Coloumns	Total width cm	Item no.
Painted	1	703.5	BB78840515
Painted	2	1027.5	BB78840525
Painted	3	1351.5	BB78840535

Height 182 (195.2 cm) - with 4 cupboards in height

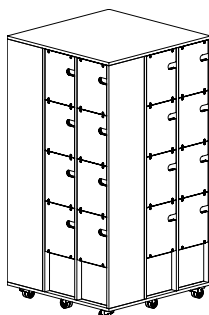

Type	Coloumns	Total width cm	Item no.
Painted	-	-	-
Painted	2	1027.5	BB78840825
Painted	3	1351.5	BB78840835



Centria Kirjasto Kokkola, Finland
Slimline shelving system

WOODEN SHELVING

CHECK LIST

When constructing your own shelving, there are many factors to be taken into consideration and most importantly, you must remember to order all parts. Below you will find a check list of components you need to consider when constructing your own wooden shelving.



PANELS

Before constructing your shelving system you must know the height and depth of your finished shelving. You must then choose which end panel (the main component of your shelving) you would like – Slimline or Frontline - see from page 48. For double-sided shelving you also have the option of choosing an end panel bay for Slimline or Frontline - see page 20 and 34.

BACK PANELLING

To support the shelving you must choose between either a steel back frame or a back panel. Steel back frame is standard in wooden shelving configurations. See from page 52.

COMPONENTS - PLINTHS & CASTORS

Extra components to complete the function and design of your shelving. See page 55.

SHELVES & BRACKETS

There are some variables to consider when choosing shelves: vertical or sloping, wood or steel, and which type of top shelf should complete the shelving. Remember to order brackets, when not included. See from page 56.

FUNCTIONS

A variety of possibilities to create the exact shelving you wish. Exchange shelving for one of the many options: browsers, cabinets, work stations or multimedia storage. See from page 66.

PANELS

FRONTLINE 22 MM PANELS

Frontline (FSC) 22 mm panels, for description see page 22.

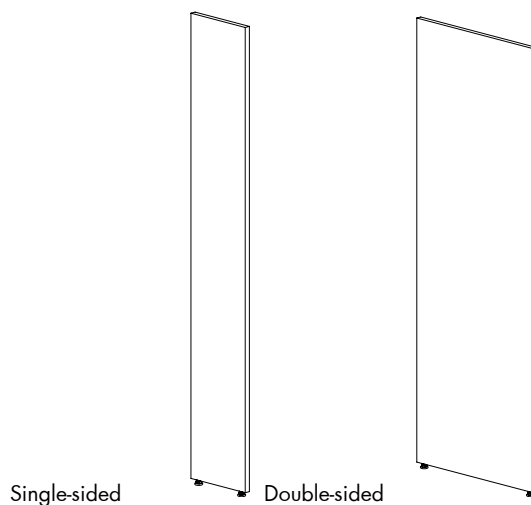

Frontline (FSC) panels - single-sided

Height	Shelf depth cm	Left Item no.	Right Item no.	Intermediate Item no.
92	25	B7800167216	B7800167217	B7800167218
92	30	B7800167316	B7800167317	B7800167318
92	40	B7800167416	B7800167417	B7800167418
122	25	B7800162216	B7800162217	B7800162218
122	30	B7800162316	B7800162317	B7800162318
122	40	B7800162416	B7800162417	B7800162418
152	25	B7800165216	B7800165217	B7800165218
152	30	B7800165316	B7800165317	B7800165318
152	40	B7800165416	B7800165417	B7800165418
182	25	B7800168216	B7800168217	B7800168218
182	30	B7800168316	B7800168317	B7800168318
182	40	B7800168416	B7800168417	B7800168418
212	25	B7800161216	B7800161217	B7800161218
212	30	B7800161316	B7800161317	B7800161318
212	40	B7800161416	B7800161417	B7800161418

Frontline (FSC) panels - double-sided

Height	Shelf depth cm	Outside Item no.	Intermediate Item no.
92	25	B7800167229	B7800167228
92	30	B7800167329	B7800167328
92	40	B7800167429	B7800167428
122	25	B7800162229	B7800162228
122	30	B7800162329	B7800162328
122	40	B7800162429	B7800162428
152	25	B7800165229	B7800165228
152	30	B7800165329	B7800165328
152	40	B7800165429	B7800165428
182	25	B7800168229	B7800168228
182	30	B7800168329	B7800168328
182	40	B7800168429	B7800168428
212	25	B7800161229	B7800161228
212	30	B7800161329	B7800161328
212	40	B7800161429	B7800161428

Frontline (FSC) 38 mm panels, for description see page 22.

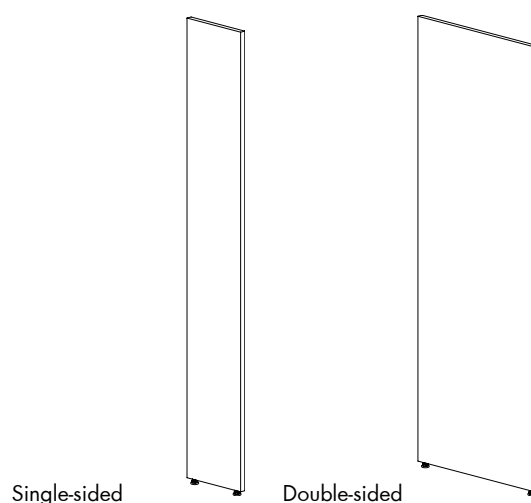

Frontline (FSC) 38 panels - single-sided

Height	Shelf depth cm	Left Item no.	Right Item no.	Intermediate Item no.
122	25	B7820042216	B7820042217	B7820042218
122	30	B7820042316	B7820042317	B7820042318
122	40	B7820042416	B7820042417	B7820042418
152	25	B7820045216	B7820045217	B7820045218
152	30	B7820045316	B7820045317	B7820045318
152	40	B7820045416	B7820045417	B7820045418
182	25	B7820048216	B7820048217	B7820048218
182	30	B7820048316	B7820048317	B7820048318
182	40	B7820048416	B7820048417	B7820048418
212	25	B7820041216	B7820041217	B7820041218
212	30	B7820041316	B7820041317	B7820041318
212	40	B7820041416	B7820041417	B7820041418

Frontline (FSC) 38 panels - double-sided

Height	Shelf depth cm	Outside Item no.	Intermediate Item no.
122	25	B7820042229	B7820042228
122	30	B7820042329	B7820042328
122	40	B7820042429	B7820042428
152	25	B7820045229	B7820045228
152	30	B7820045329	B7820045328
152	40	B7820045429	B7820045428
182	25	B7820048229	B7820048228
182	30	B7820048329	B7820048328
182	40	B7820048429	B7820048428
212	25	B7820041229	B7820041228
212	30	B7820041329	B7820041328
212	40	B7820041429	B7820041428

PANELS

SLIMLINE PANELS

Slimline panels, for description see page 14.

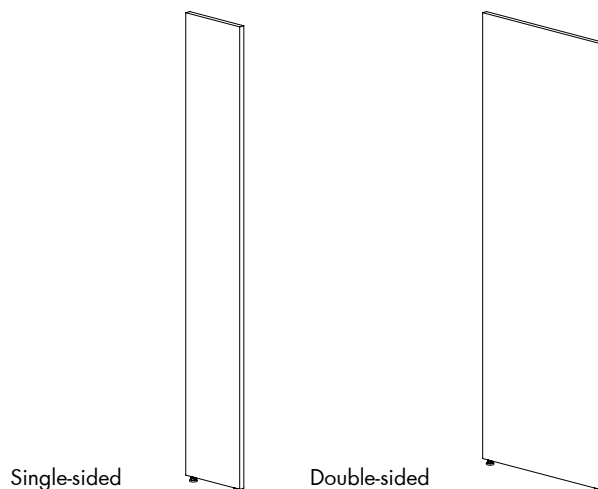

Slimline panels - single-sided

Height	Shelf depth cm	Left Item no.	Right Item no.	Intermediate Item no.
92	25	B7800027216	B7800027217	B7800027218
92	30	B7800027316	B7800027317	B7800027318
92	40	B7800027416	B7800027417	B7800027418
122	25	B7800022216	B7800022217	B7800022218
122	30	B7800022316	B7800022317	B7800022318
122	40	B7800022416	B7800022417	B7800022418
152	25	B7800025216	B7800025217	B7800025218
152	30	B7800025316	B7800025317	B7800025318
152	40	B7800025416	B7800025417	B7800025418
182	25	B7800028216	B7800028217	B7800028218
182	30	B7800028316	B7800028317	B7800028318
182	40	B7800028416	B7800028417	B7800028418
212	25	B7800021216	B7800021217	B7800021218
212	30	B7800021316	B7800021317	B7800021318
212	40	B7800021416	B7800021417	B7800021418

Slimline panels - double-sided

Height	Shelf depth cm	Outside Item no.	Intermediate Item no.
92	25	B7800027229	B7800027228
92	30	B7800027329	B7800027328
92	40	B7800027429	B7800027428
122	25	B7800022229	B7800022228
122	30	B7800022329	B7800022328
122	40	B7800022429	B7800022428
152	25	B7800025229	B7800025228
152	30	B7800025329	B7800025328
152	40	B7800025429	B7800025428
182	25	B7800028229	B7800028228
182	30	B7800028329	B7800028328
182	40	B7800028429	B7800028428
212	25	B7800021229	B7800021228
212	30	B7800021329	B7800021328
212	40	B7800021429	B7800021428

PANELS

DISPLAY END PANELS

Slimline display end panels - double-sided

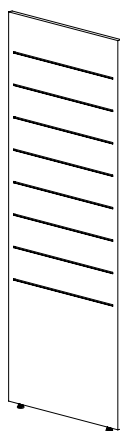

Height	Shelf depth cm	Slimline Item no.
92	25+25	B78000672
92	30+30	B78000673
122	25+25	B78000622
122	30+30	B78000623
152	25+25	B78000652
152	30+30	B78000653
182	25+25	B78000682
182	30+30	B78000683
212	25+25	B78000612
212	30+30	B78000613

Frontline (FSC) display end panels - double-sided



Height	Shelf depth cm	Frontline Item no.
92	25+25	B78001872
92	30+30	B78001873
122	25+25	B78001822
122	30+30	B78001823
152	25+25	B78001852
152	30+30	B78001853
182	25+25	B78001882
182	30+30	B78001883
212	25+25	B78001812
212	30+30	B78001813

BACK PANELS

veneER AND PAINTED BACK PANELS

Wooden back panel (FSC) for use with steel or wooden top shelf with standard depth

Use with steel top shelf on pages 58-60 or with wooden top shelf - standard depth on page 55.

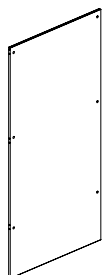

Height cm	Module cm	Veneer Item no.	Painted Item no.
92	75	B7822047742	B7822047744
92	90	B7822047942	B7822047944
92	100	B7822047142	B7822047144
122	75	B7822042742	B7822042744
122	90	B7822042942	B7822042944
122	100	B7822042142	B7822042144
152	75	B7822045742	B7822045744
152	90	B7822045942	B7822045944
152	100	B7822045142	B7822045144
182	75	B7822048742	B7822048744
182	90	B7822048942	B7822048944
182	100	B7822048142	B7822048144
212	75	B7822041742	B7822041744
212	90	B7822041942	B7822041944
212	100	B7822041142	B7822041144

Wooden back panel (FSC) for use with wooden top shelf in full depth

Use with wooden top shelf - full depth on page 57.

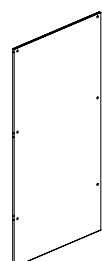

Height cm	Module cm	Veneer Item no.	Painted Item no.
92	75	B7822047762	B7822047764
92	90	B7822047962	B7822047964
92	100	B7822047162	B7822047164
122	75	B7822042762	B7822042764
122	90	B7822042962	B7822042964
122	100	B7822042162	B7822042164
152	75	B7822045762	B7822045764
152	90	B7822045962	B7822045964
152	100	B7822045162	B7822045164
182	75	B7822048762	B7822048764
182	90	B7822048962	B7822048964
182	100	B7822048162	B7822048164
212	75	B7822041762	B7822041764
212	90	B7822041962	B7822041964
212	100	B7822041162	B7822041164

Wooden back panel (FSC) - for Frontline 38 mm top and bottom shelf in full depth

A back panel is used instead of the steel frame. Use with Frontline 38 mm top and bottom shelf on page 55.



Height cm	Module cm	Veneer Item no.	Painted Item no.
122	75	B782005272	B782005274
122	90	B782005292	B782005294
152	75	B782005572	B782005574
152	90	B782005592	B782005594
182	75	B782005872	B782005874
182	90	B782005892	B782005894
212	75	B782005172	B782005174
212	90	B782005192	B782005194

BACK PANELS

MELAMINE BACK PANELS

Wooden back panel (FSC) for use with steel top shelf or wooden top with standard depth

Use with steel top shelf on pages 68-70
or with wooden top shelf - standard
depth on page 57.

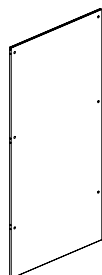

Height cm	Module cm	Melamine Item no.
92	75	B7822047746
92	90	B7822047946
92	100	B7822047146
122	75	B7822042746
122	90	B7822042946
122	100	B7822042146
152	75	B7822045746
152	90	B7822045946
152	100	B7822045146
182	75	B7822048746
182	90	B7822048946
182	100	B7822048146
212	75	B7822041746
212	90	B7822041946
212	100	B7822041146

Wooden back panel (FSC) for use with wooden top shelf in full depth

Use with wooden top shelf - full depth on
page 55.

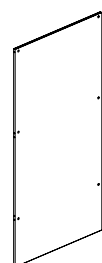

Height cm	Module cm	Melamine Item no.
92	75	B7822047766
92	90	B7822047966
92	100	B7822047166
122	75	B7822042766
122	90	B7822042966
122	100	B7822042166
152	75	B7822045766
152	90	B7822045966
152	100	B7822045166
182	75	B7822048766
182	90	B7822048966
182	100	B7822048166
212	75	B7822041766
212	90	B7822041966
212	100	B7822041166

BACK FRAMES

STEEL BACK FRAME

Steel back frame (incl. fittings)

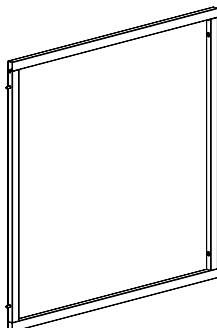

Height cm	Module cm	Starter bay Item no.	Price EUR	Add-on bay Item no.
All heights	75	B7822137ZZZ8	-	B7822137ZZZ9
	90	B7822139ZZZ8	-	B7822139ZZZ9
	100	B7822131ZZZ8	-	B7822131ZZZ9

COMPONENTS

PLINTHS, WHEEL STANDS AND CASTORS

Plinth (FSC)

Incl. fittings. H12 cm. Cannot be used with frame for castors.

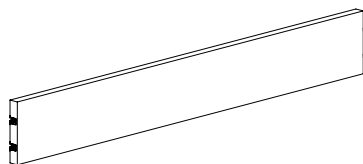

Module
cm

75

90

100

Item no.

B7820017

B7820019

B7820011

Frame for castors

A set of 2 frames for 4 castors. Only to be used for double-sided shelving, max. height 152 cm.
Excl. castors.

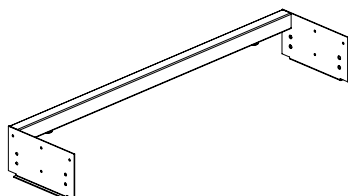

Module
cm

75

90

100

Item no.

B7860007

B7860009

B7860001

Castors

H 11.2 cm, Ø8 cm.

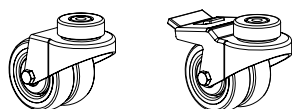

Type

Without brake

With brake

Item no.

B7860100

B7860101

SHELVES

STEEL SHELVES - FOR HANGING/BACKEDGE BOOK SUPPORT

Steel shelf with acrylic backedge and brackets - for hanging book support

Acrylic backedge 17 mm.

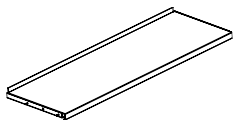

Module cm	Shelf depth cm	With. brackets Item no.
75	25	BB4007741127
75	30	BB4007741137
75	40	BB4007741147
90	25	BB4007741129
90	30	BB4007741139
90	40	BB4007741149
100	25	BB4007741121
100	30	BB4007741131
100	40	BB4007741141

Steel shelf with acrylic backedge and without brackets - for hanging book support

Acrylic backedge 17 mm. Brackets must be ordered separately. See next page.

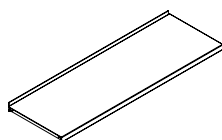

Module cm	Shelf depth cm	Without brackets Item no.
75	25	B40101327
75	30	B40101337
75	40	B40101347
90	25	B40101329
90	30	B40101339
90	40	B40101349
100	25	B40101321
100	30	B40101331
100	40	B40101341

Steel shelf with steel backedge and brackets - for backedge book support

Steel backedge 47 mm.

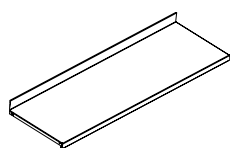

Module cm	Shelf depth cm	With. brackets Item no.
75	25	BB4007641127
75	30	BB4007641137
75	40	BB4007641147
90	25	BB4007641129
90	30	BB4007641139
90	40	BB4007641149
100	25	BB4007641121
100	30	BB4007641131
100	40	BB4007641141

Steel shelf with steel backedge and without brackets - for backedge book support

Steel backedge 47 mm. Brackets must be ordered separately. See next page.

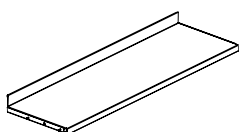

Module cm	Shelf depth cm	Without brackets Item no.
75	25	B40100127
75	30	B40100137
75	40	B40100147
90	25	B40100129
90	30	B40100139
90	40	B40100149
100	25	B40100121
100	30	B40100131
100	40	B40100141

SHELVES

BRACKETS FOR STEEL SHELVES

Bracket for steel shelves with steel or acrylic backedge

* Can be used for D25 and 30 cm shelves.

** Can be used for D25, 30 and 40 cm shelves.

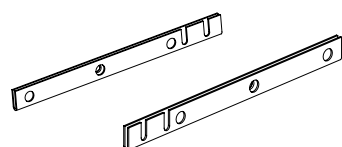

Type	Shelf depth cm	Item no.
Left	25	B78300128
Right	25	B78300129
Left*	30	B78300138
Right*	30	B78300139
Left**	40	B78300148
Right**	40	B78300149

45°/60° steel plate bracket for steel shelf with steel backedge

Can only be used with D30 cm shelves.

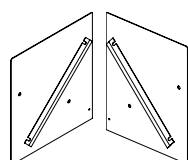

Type	Degree	Panel depth cm	Item no.
Left	45	30, 40	B7857018
Right	45	30, 40	B7857019
Left	60	25, 30, 40	B7856028
Right	60	25, 30, 40	B7856029

7.5° reverse tilted steel plate bracket for steel shelf with steel backedge

* Use with min. D30 cm

** Use with min. D40 cm

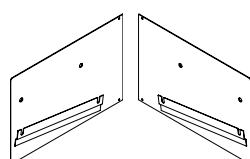

Type	Shelf depth cm	Item no.
Left*	25	B783017238
Right*	25	B783017239
Left**	30	B783017348
Right**	30	B783017349

Acrylic backedge

Spare part. Included when ordering metal shelf with acrylic backedge

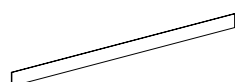

Module cm	Item no.
75	B4010127
90	B4010129
100	B4010121

SHELVES

STEEL TOP SHELVES - FOR HANGING BOOK SUPPORT

Steel top shelf with brackets - to be used with shelves for hanging book support

	Module	Shelf depth	With brackets
	cm	cm	Item no.
	75	25	BB4007741227
	75	30	BB4007741237
	75	40	BB4007741247
	90	25	BB4007741229
	90	30	BB4007741239
	90	40	BB4007741249
	100	25	BB4007741221
	100	30	BB4007741231
	100	40	BB4007741241

Steel top shelf without brackets - to be used with shelves for hanging book support

Brackets must be ordered separately. See below.

	Module	Shelf depth	Without brackets
	cm	cm	Item no.
	75	25	B40101127
	75	30	B40101137
	75	40	B40101147
	90	25	B40101129
	90	30	B40101139
	90	40	B40101149
	100	25	B40101121
	100	30	B40101131
	100	40	B40101141

Steel brackets for steel top shelf

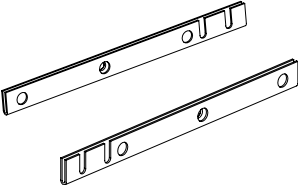
	Type	Shelf depth	Item no.
		cm	
	Left	25	B78300128
	Right	25	B78300129
	Left	30	B78300138
	Right	30	B78300139
	Left	40	B78300148
	Right	40	B78300149

Shelf bridge for steel top shelf

Used to minimize gap between top shelves without acrylic backedge on double-sided shelving.

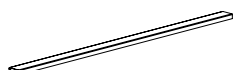

Module	Item no.
cm	
75	B7860157
90	B7860159

Extra fittings for top and bottom bracket

Spare part. Are included when ordering brackets for top and bottom shelves.

Item no.

B784738

SHELVES

STEEL TOP SHELVES - FOR BACKEDGE BOOK SUPPORT

Steel top shelf with brackets - to be used with steel shelves for backedge book support

	Module	Shelf depth	With brackets
	cm	cm	Item no.
	75	25	BB4007641227
	75	30	BB4007641237
	75	40	BB4007641247
	90	25	BB4007641229
	90	30	BB4007641239
	90	40	BB4007641249
	100	25	BB4007641221
	100	30	BB4007641231
	100	40	BB4007641241

Steel top shelf without brackets - to be used with steel shelves for backedge book support

Brackets must be ordered separately.
See below.

	Module	Shelf depth	Without brackets
	cm	cm	Item no.
	75	25	B40100327
	75	30	B40100337
	75	40	B40100347
	90	25	B40100329
	90	30	B40100339
	90	40	B40100349
	100	25	B40100321
	100	30	B40100331
	100	40	B40100341

Steel brackets for steel top shelf

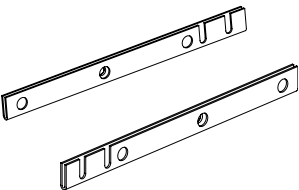
	Type	Shelf depth	Item no.
		cm	
	Left	25	B78300128
	Right	25	B78300129
	Left	30	B78300138
	Right	30	B78300139
	Left	40	B78300148
	Right	40	B78300149

Extra fittings for top and bottom bracket

Spare part. Are included when ordering
brackets for top and bottom shelves.

Item no.

B784738

SHELVES

STEEL TOP SHELVES WITH SIGN PROFILE - FOR BACKEDGE BOOK SUPPORT

Steel top shelf with sign profile with brackets - to be used with steel shelves for backedge book support

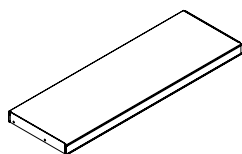

Module cm	Shelf depth cm	With brackets Item no.
75	25	BB400754127
75	30	BB400754137
75	40	BB400754147
90	25	BB400754129
90	30	BB400754139
90	40	BB400754149
100	25	BB400754121
100	30	BB400754131
100	40	BB400754141

Steel top shelf with sign profile without brackets - to be used with steel shelves for backedge book support

Brackets must be ordered separately.
See below.

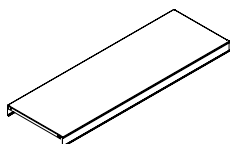

Module cm	Shelf depth cm	Without brackets Item no.
75	25	B40100527
75	30	B40100537
75	40	B40100547
90	25	B40100529
90	30	B40100539
90	40	B40100549
100	25	B40100521
100	30	B40100531
100	40	B40100541

Steel bracket for steel top shelf

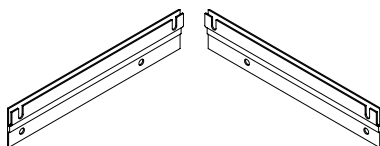

Type	Shelf depth cm	Item no.
Left	25	B78301528
Right	25	B78301529
Left	30	B78301538
Right	30	B78301539
Left	40	B78301548
Right	40	B78301549

Label for top shelf with sign profile

H41 x L1000 mm. To be inserted in the profile on topshelves with sign profile.
To be cut to the required length by the customer.

Item no.

B40113002

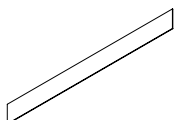

SHELVES

STEEL SLOPING SHELVES

Steel sloping shelf - ideal for magazines and newspapers

Incl. fittings. Can be positioned in either 45° or 60° angle. With 25 mm edge with frontlip.

Module cm	Depth of shelving - cm
75	25/30/40
90	25/30/40

Item no.

B7830207

B7830209

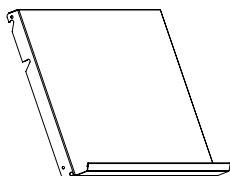

Steel sloping shelf - ideal for books

Incl. fittings. Can be positioned in either 45° or 60° angle. With 27 mm edge.

Module cm	Depth of shelving - cm
75	25/30/40
90	25/30/40
100	25/30/40

Item no.

B7830257

B7830259

B7830251

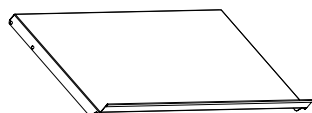

SHELVES

WOODEN SHELVES

Wooden intermediate shelf (FSC) - without backedge

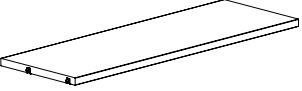
Incl. fittings	Module cm	Shelf depth cm	Item no.
	75	25	B78210327
	75	30	B78210337
	75	40	B78210347
	90	25	B78210329
	90	30	B78210339
	90	40	B78210349

Wooden intermediate shelf (FSC) - with steel backedge for backedge book support

Incl. fittings	Module cm	Shelf depth cm	Item no.
	75	25	B78211127
	75	30	B78211137
	75	40	B78211147
	90	25	B78211129
	90	30	B78211139
	90	40	B78211149

SHELVES

WOODEN TOP SHELVES

Wooden top shelf (FSC) - standard depth

Incl. fittings. Can be used with back panels on pages 52-53.



Module cm	Shelf depth cm	Single-sided bay Item no.
75	25	B782101278
75	30	B782101378
75	40	B782101478
90	25	B782101298
90	30	B782101398
90	40	B782101498
100	25	B782101218
100	30	B782101318
100	40	B782101418

Wooden top shelf (FSC) - full depth

Incl. fittings. Can be used with back panels on pages 52-53.

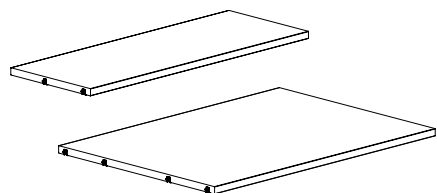

Module cm	Shelf depth cm	Single-sided bay Item no.	Double-sided bay Item no.
75	25 = 28/53,7	B782101279	B78210727
75	30 = 33/63,7	B782101379	B78210737
75	40 = 43/83,7	B782101479	B78210747
90	25 = 28/53,7	B782101299	B78210729
90	30 = 33/63,7	B782101399	B78210739
90	40 = 43/83,7	B782101499	B78210749
100	25 = 28/53,7	B782101219	B78210721
100	30 = 33/63,7	B782101319	B78210731
100	40 = 43/83,7	B782101419	B78210741

Wooden top and bottom shelf (FSC)- only for Frontline 38 mm

Incl. fittings. To be used with back panel B782007xxx for Frontline 38 shown on page 53.

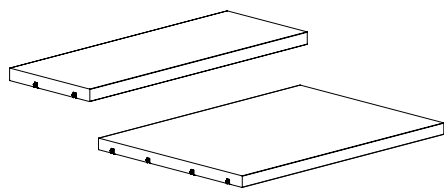

Module cm	Shelf depth cm	Single-sided bay Item no.	Double-sided bay Item no.
75	25 = 28.3/54.3	B782009271	B782009272
75	30 = 33.3/64.3	B782009371	B782009372
75	40 = 43.3/84.3	B782009471	B782009472
90	25 = 28.3/54.3	B782009291	B782009292
90	30 = 33.3/64.3	B782009391	B782009392
90	40 = 43.3/84.3	B782009491	B782009492
100	25 = 28.3/54.3	B782009211	B782009212
100	30 = 33.3/64.3	B782009311	B782009312
100	40 = 43.3/84.3	B782009411	B782009412

SHELVES

WOODEN BOTTOM SHELVES

Wooden bottom shelf (FSC) - without backedge

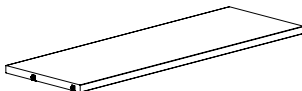
Incl. fittings	Module cm	Shelf depth cm	Item no.
	75	25	B78210527
	75	30	B78210537
	75	40	B78210547
	90	25	B78210529
	90	30	B78210539
	90	40	B78210549

Wooden bottom shelf (FSC) - with steel backedge for backedge book support

Incl. fittings	Module cm	Shelf depth cm	Item no.
	75	25	B78211327
	75	30	B78211337
	75	40	B78211347
	90	25	B78211329
	90	30	B78211339
	90	40	B78211349

SHELVES

WOODEN SLOPING AND ANGLED SHELVES

Wooden sloping shelf - 60° - for Slimline

Incl. fittings	Module cm	Depth of shelving - cm	Item no.
	90	25, 30, 40	B7821099

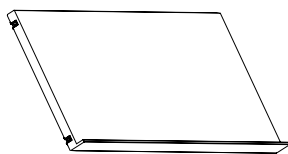

Steel angled bottom shelf

Incl. fittings	Module cm	Depth of shelving - cm	Item no.
	75	25, 30, 40	B7825907
	90	25, 30, 40	B7825909

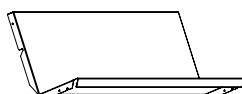

Wooden corner shelf for double-sided shelving system

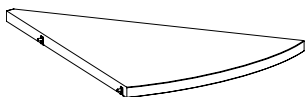
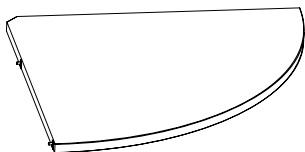
Incl. fittings	Degree of angle	Depth of shelving - cm	Item no.
	45°	25/25	B7840071
	90°	25/25	B7840072
	45°	30/30	B7840073
	90°	30/30	B7840074

FUNCTIONS

Add multiple functionalities to your wooden shelving system! The wooden shelving systems provides a framework for building your own personalized shelving system that fits the requirements of your library and target group. This can be done by replacing shelves with functional components.

Choose one or more of the following function components to personalise and accommodate your own requirements into the shelving system:



Book supports



Browsers



Multimedia storage



Magazine display and storage



Cabinets and doors



Workstations



Signage

Backedge book support for steel shelf with steel backedge

Chromed steel, Ø6 mm, with a nylon glider. The back edge book supports come in 2 models; "standard" supports books on the left hand side of the book support, while "laterally" supports books on the right hand side.

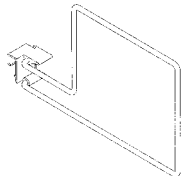

	Shelf depth cm	Item no.
Standard model	22.5/25	B4011221
Standard model	30	B4011222
High model	25/30	B4011223
Laterally reversed	22.5/25	B4011224
Laterally reversed	30	B4011225

Hanging book support for steel shelf with acrylic backedge

Available in chrome steel or BCI standard steel colours.



Type	Height cm	Item no.
Normal	20	B4011242
Folio	25	B4011245

Rail for hanging book support for wooden shelves

Incl. fittings

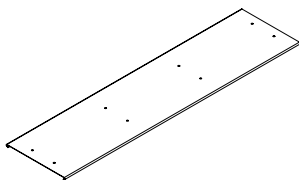

Module	Shelf depth cm	Item no.
75	25, 30, 40	B4022007
90	25, 30, 40	B4022009

Angled book support

W15 x H15 x D15 cm. Available in BCI standard steel colours.

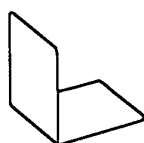

Item no.

B401120

FUNCTIONS

BROWSERS

Single browser - one level - without/with pull-out frame

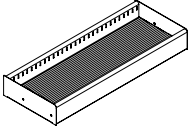
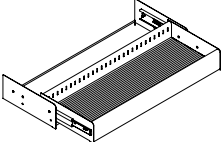
W75 cm. Incl. fittings and rubber mat. Excl. tubes	Panel depth cm	Height cm	Depth cm	No. of dividers	Item no.	
					Without pull-out function	With pull-out function
 	30	10	30 *1	0	B405070473100	B405070473500
	30	10	30	1	B405070473101	B405070473501
	30	10	30	2	B405070473102	B405070473502
	30	10	30	4	B405070473104	B405070473504
	40	10	30	0	B405070474100	B405070474500
	40	10	30	1	B405070474101	B405070474501
	40	10	30	2	B405070474102	B405070474502
	40	10	30	4	B405070474104	B405070474504

Single browser - one level - without/with pull-out frame

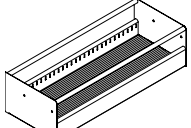
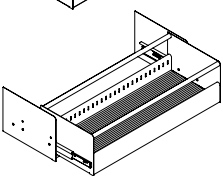
W75 cm. Incl. fittings, rubber mat and tubes.	Panel depth cm	Height cm	Depth cm	No. of dividers	Item no.	
					Without pull-out function	With pull-out function
 	30	20	30 *2	0	B405070473200	B405070473600
	30	20	30	1	B405070473201	B405070473601
	30	20	30	2	B405070473202	B405070473602
	30	20	30	4	B405070473204	B405070473604
	40	20	30	0	B405070474200	B405070474600
	40	20	30	1	B405070474201	B405070474601
	40	20	30	2	B405070474202	B405070474602
	40	20	30	4	B405070474204	B405070474604

Single browser - one level - without/with pull-out frame

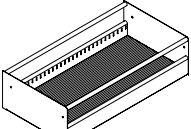
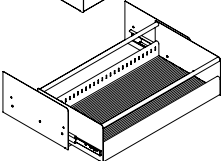
W75 cm. Incl. fittings, rubber mat and tubes.	Panel depth cm	Height cm	Depth cm	No. of dividers	Item no.	
					Without pull-out function	With pull-out function
 	30	20	40 *3	0	B405070473300	Not available
	30	20	40	1	B405070473301	Not available
	30	20	40	2	B405070473302	Not available
	30	20	40	4	B405070473304	Not available
	40	20	40	0	B405070474300	B405070474700
	40	20	40	1	B405070474301	B405070474701
	40	20	40	2	B405070474302	B405070474702
	40	20	40	4	B405070474304	B405070474704

Double browser - two levels - without/with pull-out frame

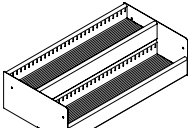
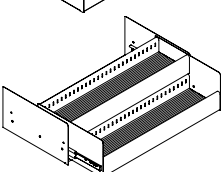
W75 cm. Incl. fittings and rubber mat. Excl. tubes	Panel depth cm	Height cm	Depth cm	No. of dividers	Item no.	
					Without pull-out function	With pull-out function
 	30	20	40 *4	0	B405070473400	Not available
	30	20	40	2	B405070473402	Not available
	30	20	40	4	B405070473404	Not available
	30	20	40	8	B405070473408	Not available
	40	20	40	0	B405070474400	B405070474800
	40	20	40	2	B405070474402	B405070474802
	40	20	40	4	B405070474404	B405070474804
	40	20	40	8	B405070474408	B405070474808

Single browser - one level - without/with pull-out frame

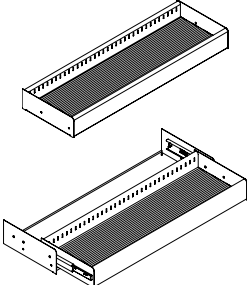
W90 cm. Incl. fittings and rubber mat. Excl. tubes	Panel depth cm	Height cm	Depth cm	No. of dividers	Item no. Without pull-out function	Item no. With pull-out function
	30	10	30 *1	0	B405070493100	B405070493500
	30	10	30	2	B405070493102	B405070493502
	30	10	30	4	B405070493104	B405070493504
	30	10	30	5	B405070493105	B405070493505
	40	10	30	0	B405070494100	B405070494500
	40	10	30	2	B405070494102	B405070494502
	40	10	30	4	B405070494104	B405070494504
	40	10	30	5	B405070494105	B405070494505

Single browser - one level - without/with pull-out frame

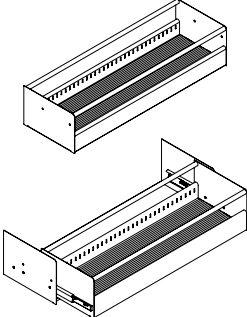
W90 cm. Incl. fittings, rubber mat and tubes.	Panel depth cm	Height cm	Depth cm	No. of dividers	Item no. Without pull-out function	Item no. With pull-out function
	30	20	30 *2	0	B405070493200	B405070493600
	30	20	30	2	B405070493202	B405070493602
	30	20	30	4	B405070493204	B405070493604
	30	20	30	5	B405070493205	B405070493605
	40	20	30	0	B405070494200	B405070494600
	40	20	30	2	B405070494202	B405070494602
	40	20	30	4	B405070494204	B405070494604
	40	20	30	5	B405070494205	B405070494605

Single browser - one level - without/with pull-out frame

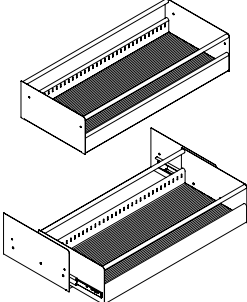
W90 cm. Incl. fittings, rubber mat and tubes.	Panel depth cm	Height cm	Depth cm	No. of dividers	Item no. Without pull-out function	Item no. With pull-out function
	30	20	40 *3	0	B405070493300	Not available
	30	20	40	2	B405070493302	Not available
	30	20	40	4	B405070493304	Not available
	30	20	40	5	B405070493305	Not available
	40	20	40	0	B405070494300	B405070494700
	40	20	40	2	B405070494302	B405070494702
	40	20	40	4	B405070494304	B405070494704
	40	20	40	5	B405070494305	B405070494705

Double browser - two levels - without/with pull-out frame

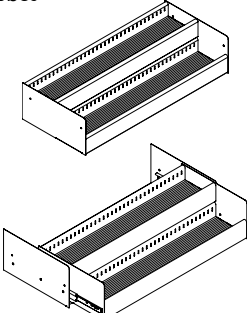
W90 cm. Incl. fittings and rubber mat. Excl. tubes	Panel depth cm	Height cm	Depth cm	No. of dividers	Item no. Without pull-out function	Item no. With pull-out function
	30	20	40 *4	0	B405070493400	Not available
	30	20	40	4	B405070493404	Not available
	30	20	40	8	B405070493408	Not available
	30	20	40	10	B405070493410	Not available
	40	20	40	0	B405070494400	B405070494800
	40	20	40	4	B405070494404	B405070494804
	40	20	40	8	B405070494408	B405070494808
	40	20	40	10	B405070494410	B405070494810

FUNCTIONS

BROWSERS

Dividers for browsers

Chromed steel.

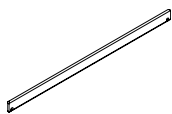

Type	Height cm	Depth cm	Item no.
Single	10	30	B4011603
Single	20	30	B4011603
Single	20	40	B4011604
Double	20	40	B4011601

Capacity examples for 75 cm single/double browser without pullout (see page 68-69)

Type	W cm	H x D cm	CD cases	DVD cases	CD pockets	Picture books	Comic picture books	
			5 rows	5 rows	5 rows	3 rows	2 rows	
*1	Single	75	10 x 30	100	75	325	-	-
*2	Single	75	20 x 30	100	75	325	90	40
*3	Single	75	20 x 40	150	105	325	120	50
			2 x 5 rows	2 x 5 rows	2 x 5 rows	3 rows	2 rows	
*4	Double	75	20 x 40	130	95	400	-	-

Capacity examples for 75 cm single/double browser with pullout (see page 68-69)

Type	W cm	H x D cm	CD cases	DVD cases	CD pockets	Picture books	Comic picture books	
			5 rows	5 rows	5 rows	3 rows	2 rows	
*1	Single	75 cm	10 x 30	80	60	260	-	-
*2	Single	75 cm	20 x 30	80	60	260	90	40
*3	Single	75 cm	20 x 40	120	84	340	120	50
			2 x 5 rows	2 x 5 rows	2 x 5 rows	3 rows	2 rows	
*4	Double	75 cm	20 x 40	104	76	320	-	-

Capacity examples for 90 cm single/double browser without pullout (see page 68-69)

Type	W cm	H x D cm	CD cases	DVD cases	CD pockets	Picture books	Comic picture books	
			6 rows	6 rows	6 rows	4 rows	3 rows	
*1	Single	90 cm	10 x 30	120	90	390	-	-
*2	Single	90 cm	20 x 30	120	90	390	120	60
*3	Single	90 cm	20 x 40	180	126	510	180	75
			2 x 6 rows	2 x 6 rows	2 x 6 rows	4 rows	3 rows	
*4	Double	90 cm	20 x 40	156	114	480	-	-

Capacity examples for 90 cm single/double browser with pullout (see page 68-69)

Type	W cm	H x D cm	CD cases	DVD cases	CD pockets	Picture books	Comic picture books	
			6 rows	6 rows	6 rows	4 rows	3 rows	
*1	Single	90 cm	10 x 30	100	75	325	-	-
*2	Single	90 cm	20 x 30	100	75	325	120	60
*3	Single	90 cm	20 x 40	150	105	425	160	75
			2 x 6 rows	2 x 6 rows	2 x 6 rows	4 rows	3 rows	
*4	Double	90 cm	20 x 40	130	95	400	-	-

FUNCTIONS

BROWSERS

Wooden picture book browser with 4 adjustable compartments (FSC)

Incl. 3 dividers and fittings.
W90 x H22/12 x D30 cm

Module
cm

Depth
cm

Item no.

90 30

B784002

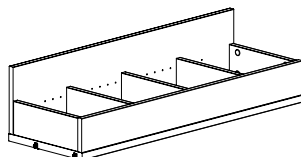

Wooden CD/DVD browser with 5 adjustable compartments (FSC)

Incl. 4 dividers and pull out fittings with
100% expansion. W90 x H17/13 x
D30

Module
cm

Depth
cm

Item no.

90 30

B7840045

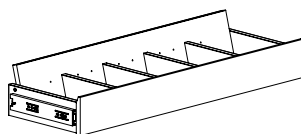

FUNCTIONS

MULTIMEDIA

Steel shelf with 5 sliding dividers

Incl. fittings. H40 x D40 cm. Can be used under browsers with D40 cm on page 69. Capacity: 75 picture books/100 music books.

Module
cm

90

Item no.

B785080

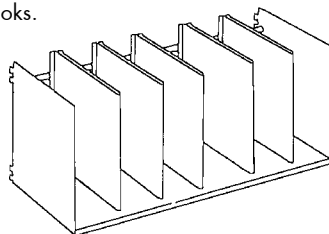

Steel shelf for CD - 5 compartments (W17.8) with 4 steel dividers

Incl. fittings. W90 x H15 x D22.5 cm.
Capacity: 75 CD's

Item no.

B785130

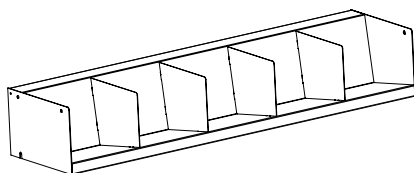

Steel shelf - 4 compartments (W22.4 cm) with 3 steel dividers

Incl. fittings. W90 x H20 x DXX cm.
Capacity: 75 picture books

Depth
cm

25

30

Item no.

B7850412

B7850413

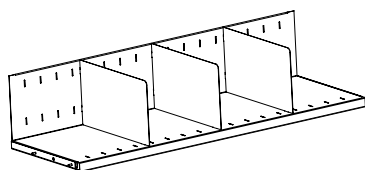

Extra steel dividers for steel shelf B785041x

H17.5 cm

Depth
cm

22.5

30

Item no.

B4010401

B4010403

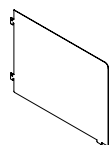

Steel shelf for pocket book/CD/DVD's

Incl. fittings. W90 x H20 x D22.5 cm
Capacity: 50-60 books.

Item no.

B785150

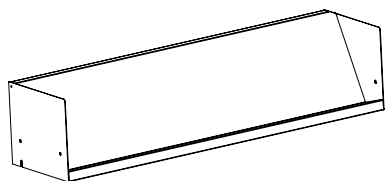

Steel shelf for CD

Incl. fittings. H17.5 x D20 cm
Capacity: cases 75 CD's

Module
cm

Item no.

75
90

B7851737
B7851739

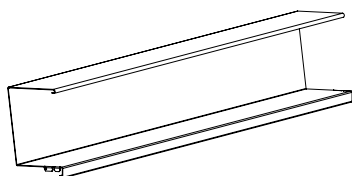

Steel shelf for DVD

Incl. fittings. H27.3 x D30 cm.
Capacity: 50-60 pocket books
/ 75 DVD's

Module
cm

Item no.

75
90

B7851707
B7851709

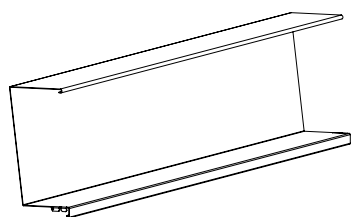

Wooden shelf (FSC) for Daisy talking book cases

Incl. moveable wooden strip to adjust
depth. W90.

Module
cm

Depth
cm

Item no.

90 25
90 30

B7840262
B7840263



FUNCTIONS

MAGAZINE DISPLAY & STORAGE

Magazine display - with 1 tip up sloping shelf

W90 x H40 x D40 cm. With space for storage of either magazines piled horizontally or vertical binders (up to 32 cm in height).

Item no.

B785100

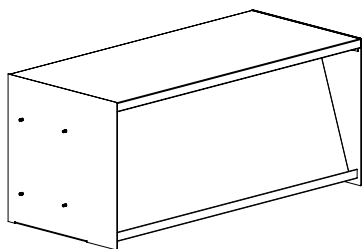

Magazine display - with 1 tip up sloping shelf and moveable dividers

W90 x H40 x D40 cm. With space for separate storage of either magazines piled horizontally or vertical binders (up to 32 cm in height). Dividers can be moved 5 cm either way.

Item no.

B785110

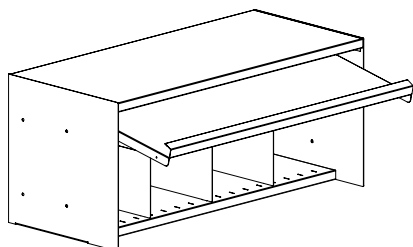

Magazine display - with 3 tip up sloping shelves

W90 x H40 x D40 cm. With space for separate storage of either magazines piled horizontally or vertical binders (up to 32 cm in height).

Item no.

B785120

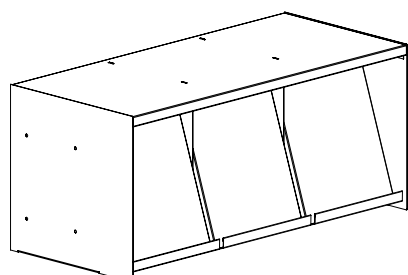

FUNCTIONS

MAGAZINE DISPLAY & STORAGE

Wooden shelves with 7 wooden dividers (FSC)

W90 x H32.8 x D30 cm Incl. fittings.
Capacity: 75 picture books/ 75
music books.

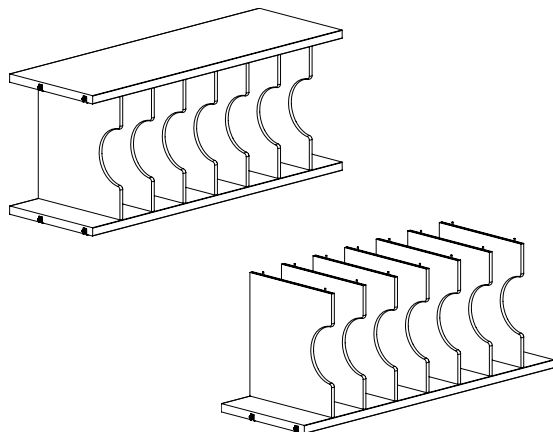

Top module
Item no.

B7840171

Bottom module
Item no.

B7840172

Wooden shelves with 13 acrylic dividers (FSC)

W90 x H32.8 x D25 cm Incl. fittings.
Capacity: 13 newspapers.

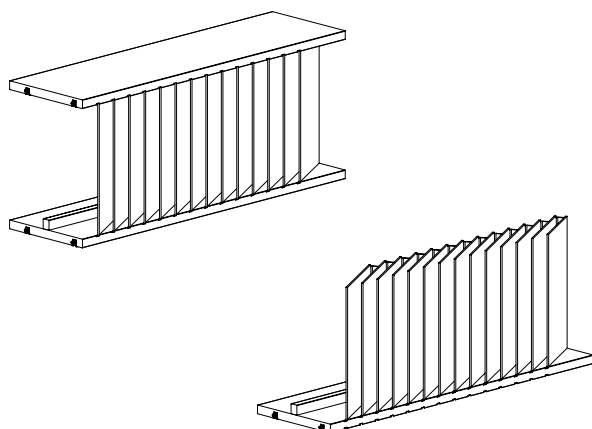

Top module
Item no.

B7840211

Bottom module
Item no.

B7840212

Wooden newspaper cassette with 8 acrylic compartments (FSC)

Incl. fittings. W90 x H61 x D30 cm
Capacity: 8 folded newspapers

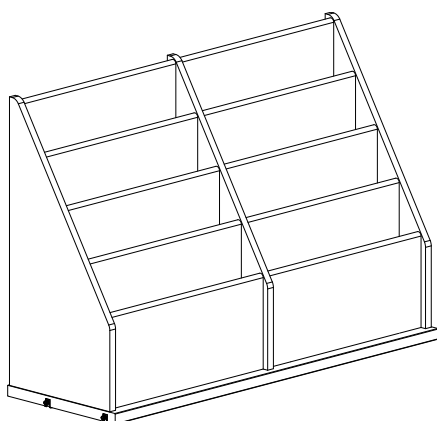

Item no.

B784009



Ål Public Library, Norway
Slimline shelving system with glass panel doors

FUNCTIONS

CABINETS AND DOORS

Steel cabinet with sliding door

W90 x D40 cm. Incl. lock and 1 shelf.

Height
cm

Item no.

62.5
80.0

B7850306
B7850307

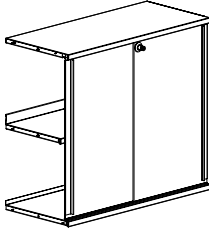

Steel cabinet with glass sliding doors - for Slimline

W90 x D30 cm. Incl. lock. Excl. back panel, see page 52. 6 mm hardened glass.

Shelves	Height cm	Height of door cm
2	92.5	85
3	122.5	115
4	152.5	145
5	182.5	175

Item no.

B7850209
B7850202
B7850205
B7850208

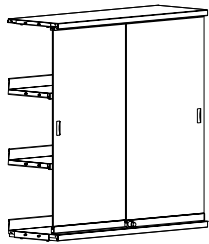

Glass panel doors - for Slimline

Incl. lock. Top and bottom shelves in wood necessary in order to be able to lock the doors. Bottom shelf to be placed 12 cm above floor.

Module cm	Height of shelving cm	Height of door cm
75	92	77.2
75	122	107.2
75	152	137.2
75	182	167.2
75	212	197.2
90	92	77.2
90	122	107.2
90	152	137.2
90	182	167.2
90	212	197.2

Item no.

B780008774
B780008274
B780008574
B780008874
B780008174

B780008794
B780008294
B780008594
B780008894
B780008194

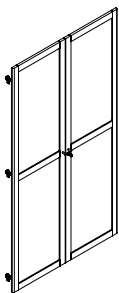

Wooden panel doors - for Slimline

Incl. lock. Top and bottom shelves in wood necessary in order to be able to lock the doors. Bottom shelf to be placed 12 cm above floor.

Module cm	Height of shelving cm	Height of door cm
75	92	77.2
75	122	107.2
75	152	137.2
75	182	167.2
75	212	197.2
90	92	77.2
90	122	107.2
90	152	137.2
90	182	167.2
90	212	197.2

Item no.

B780008776
B780008276
B780008576
B780008876
B780008176

B780008796
B780008296
B780008596
B780008896
B780008196

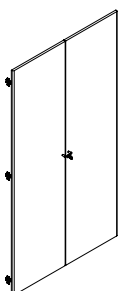

FUNCTIONS

WORK STATIONS

Steel pull-out shelf

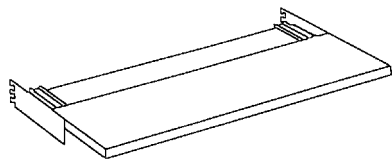

Module cm	Depth cm	Item no.
90	22.5	B7851601
90	30	B7851603

Wooden pull-out shelf (FSC)

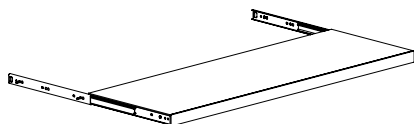

Module cm	Depth cm	Item no.
90	30	B7840109

Writing plate - wood

Excl. brackets. H2 cm.

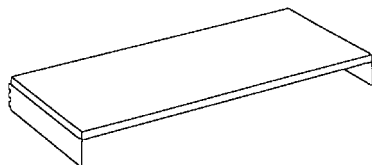

Module cm	Depth cm	Item no.
90	40	B4040124
90	50	B4040125
90	60	B4040126

Brackets for writing plate

D30 cm

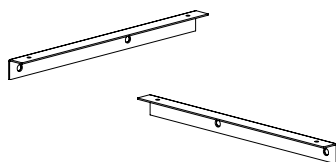

Type	Depth cm	Item no.
Left	30	B7840148
Right	30	B7840149

End panel signage for wooden end panel - flat

Fastened to the end panel with screws.
The sign has an acrylic film for insertion
of text slide.

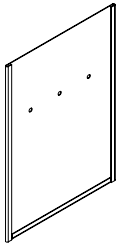

A4 vertical/upright format
A3 vertical/upright format
A3 horizontal format

Item no.

B401 10377
B401 10378
B401 10379

Plastic clip-on shelf sign with label for steel shelf with steel backedge

H2.5 x W22 cm

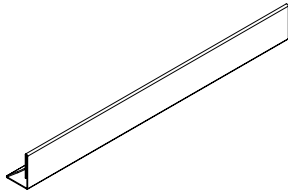

Item no.

B401 135

Label for top shelf with sign profile

H4.1 x W100 cm.
See page 60.

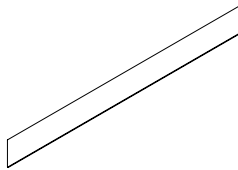

Item no.

B401 13002



The Book Big LED lighting armature can be fitted on wooden top shelves and can be mounted over 1, 2 and 3 bays by use of connect fittings. Continuous runs also require connect fitting.

The armature is CE-approved and available in white and steel as standard. For other colours, please ask customer service.

Armature

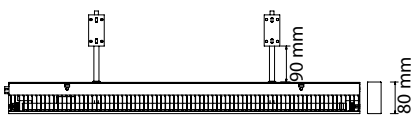

For 2 bearing arms incl. light tube and louvre. Armature housing in aluminium.

Bearing arms Standard

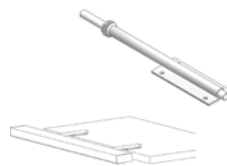

To be mounted on top shelf

Bearing arms Front edge

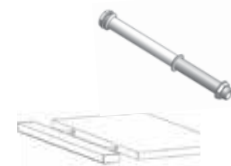

To be mounted on frontedge of predrilled top shelf/top plate (special product)

End covers



Connect fitting



LIGHTING

BOOK BIG LIGHTING

Below you will find a list of products needed when ordering lighting for 1, 2 or 3 bays. For 4 or more bays, you must use a combination of the armatures for 1, 2 or 3 bays by connecting the armatures with a connect fitting. Eg. for 10 bays, you can either use 5 x 2 bays (with 4 connect fittings) or 3 x 3 bays and 1 x 1 bay (with 3 connect fittings).

1 bay

	Item no.
Armature - module 75 - W773 x D80 x H32 mm or	B3900160773
Armature - module 90 - W923 x D80 x H32 mm or	B3900160923
Armature - module 100 - W1028 x D80 x H32 mm	B3900161028
Bearing arms, 2 pcs., standard or	B39001512
Bearing arms, 2 pcs., front edge	B39001522
End covers, 2 pcs.	B390011

2 bays

	Item no.
Armature - module 75 + 75 - W1546 x D80 x H32 mm or	B3900161546
Armature - module 90 + 90 - W1846 x D80 x H32 mm or	B3900161846
Armature - module 100 + 100 - W2056 x D80 x H32 mm	B3900162056
Bearing arms, 2 pcs., standard or	B39001512
Bearing arms, 2 pcs., front edge	B39001522
End covers, 2 pcs.	B390011

3 bays

	Item no.
Armature - module 75 + 75 + 75 - W2319 x D80 x H32 mm or	B3900162319
Armature - module 75 + 90 + 75 - W2469 x D80 x H32 mm or	B3900162469
Armature - module 90 + 75 + 90 - W2619 x D80 x H32 mm or	B3900162619
Armature - module 90 + 90 + 90 - W2769 x D80 x H32 mm	B3900162769
Bearing arms, 3 pcs., standard or	B39001513
Bearing arms, 3 pcs., front edge	B39001523
End covers, 2 pcs.	B390011

Cable 3 x 1.5 mm², L2500 mm

Item no.

B390013

Connect fitting

Item no.

B390012

LOCATIONS

WE ARE LIBRARY PEOPLE®



DENMARK

Lammhults Biblioteksdesign A/S
Dalbækvej 1
6670 Holsted

bci@bci.dk
www.bci.dk

SWEDEN

Lammhults Biblioteksdesign AB
Odlarevägen 16
226 60 Lund

eurobib@eurobib.se
www.eurobib.se

UNITED KINGDOM

thedesignconcept Ltd.
The Old Bakery,
10 Greenless Road
Cambuslang Belgrave Street
Glasgow G72 8JJ

info@thedesignconcept.co.uk
www.thedesignconcept.co.uk

FRANCE

BC Intérieur Sarl
6 allée Kepler
77420 Champs sur Marne

bci@bcinterieur.com
www.bcinterieur.com

GERMANY

Schulz Speyer Bibliothekstechnik AG
Hafenstraße 2
67346 Speyer

sales@schulzspeyer.de
www.schulzspeyer.de

NORWAY

BS Eurobib AS
Alf Bjerckes Vei 20
0582 Oslo

post@bseurobib.no
www.bseurobib.no

BELGIUM

SBNL - Schulz Benelux BVBA
Appelweg 94 C
3221 Holsbeek

info@sbnl.be
www.sbnl.be