



LINGO SHELVING SYSTEM

EUR PRICE LIST

01.01.2024



LINGO SHELVING

You will find exceptional versatility with the functional and flexible Lingo Shelving System.

It encapsulates the true meaning of flexibility. Its modular construction provides the highest degree of functionality and versatility and its style and quality makes it suitable for both contemporary and classic library environments.

The Lingo shelving system offers endless possibilities of function and design. The construction of the shelving system, with 25 mm increments, allows for easy assembly and adjustment without the use of specific tools.

Lingo is available as a single- or double-sided shelving, with or without castors, and as a straight, curved or combined solution. It can be fitted with steel or wooden shelves, as well as a wide variety of other functional components. The result – a customisable shelving systems that fits the requirements of your specific library.

You will find all the standard products in this overview. For additional inspiration we invite you to visit our website where you can find project inspiration from our latest projects around the world. Our professional sales team is ready to help you with any questions you may have.



The price list is valid from 01.01.2024 until 31.12.2024.

Conditions of sale and terms of delivery

All prices are excluding VAT and delivery. Please see our conditions of sale and terms of delivery on our website.

Updating the price list

The price list will continually be updated and can be downloaded on our website. Please contact our sales office, who will forward a log-in and password via e-mail. We reserve the right to make product and price alterations without prior notice and accept no liability for printing errors.

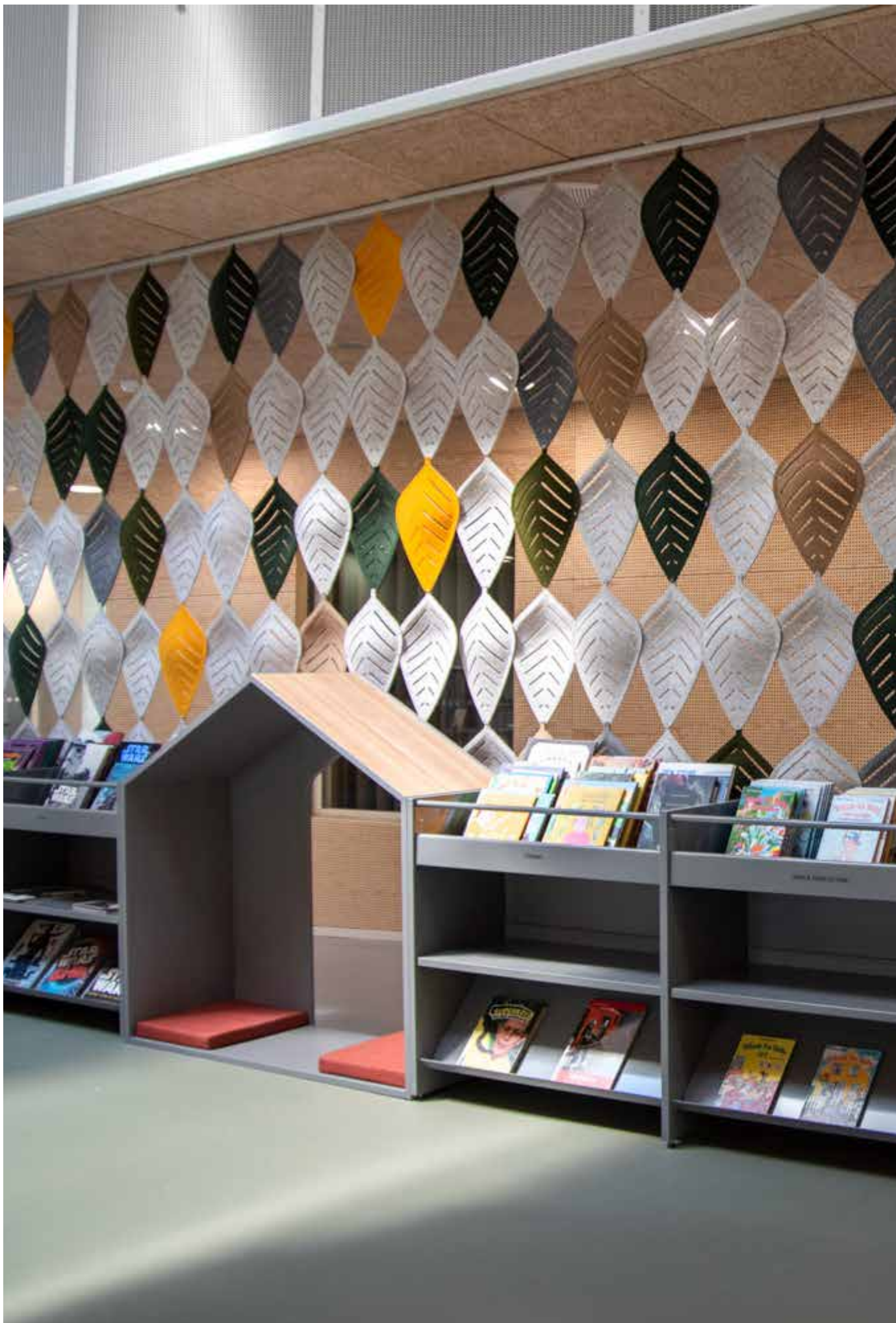

INDEX

FSC®	4
DESIGN OPTIONS	6
TECHNICAL SPECIFICATIONS	10
DIMENSIONS	20
BAY CONSTRUCTION	24
STRAIGHT AND ROUND COMBINATIONS	28

STRAIGHT CONFIGURATIONS

BBN001 - WITH ADJUSTABLE FEET, FOR TOP SHELF

Single-sided configurations with back frame.....	30
Double-sided configurations with back frame.....	32
Single-sided configurations with high wooden back panel....	38
Double-sided configurations with high wooden back panel ..	40
Single-sided configurations with low wooden back panel.....	44
Double-sided configurations with low wooden back panel....	46
Single-sided configurations with cross brace.....	50
Double-sided configurations with cross brace.....	52

BBN002 - WITH ADJUSTABLE FEET & TOP PLATE

Single-sided configurations with back frame.....	56
Double-sided configurations with back frame.....	62
Single-sided configurations with wooden back panel.....	70
Double-sided configurations with wooden back panel.....	76
Single-sided configurations with cross brace.....	84
Double-sided configurations with cross brace.....	90

BBN011 - WITH CASTOR PLATE, FOR TOP SHELF

Double-sided configurations with back frame.....	98
Double-sided configurations with wooden high back panel	104
Double-sided configurations with wooden low back panel..	110
Double-sided configurations with cross brace.....	116

BBN012 - WITH CASTOR PLATE & TOP PLATE

Double-sided configurations with back frame.....	122
Double-sided configurations with wooden back panel.....	128
Double-sided configurations with cross brace.....	134

LINGO SQUARE

With plint.....	138
With castors.....	140

COMPONENTS FOR STRAIGHT SHELVING

CHECK LIST.....

SHELVES

S1, S2, S3, S4 - steel shelves.....	144
ST1, ST2, ST3 - steel top shelves.....	156
W1, W2, W3, W4 - wooden shelves.....	166
WT1, WT3 - wooden top shelves.....	174
WO1 - wooden overlaying top plates.....	179
Display and storage.....	186

ACCESSORIES

Steel browsers.....	188
Wooden browsers.....	194
Display and storage.....	195
Book supports.....	200
Signage for front of shelf.....	202
Signage for end panel.....	204

CASTORS & PLINTHS

Visible castors.....	207
Hidden castors.....	207
Castor plates.....	208
Plinths.....	209

PANELS

With adjustable feet/for castor frame:

Single-sided wooden panels - for top shelf.....	210
Double-sided wooden panels - for top shelf.....	212
Double-sided slat wooden panels - for top shelf.....	213
Single-sided wooden panels - for overlaying top plate.....	214
Double-sided wooden panels - for overlaying top plate.....	216
Double-sided slat wooden panels - for overlaying top plate ..	217

For castor plate:

Double-sided wooden panels - for top shelf.....	218
Double-sided slat wooden panels - for top shelf.....	219
Double-sided wooden panels - for overlaying top plate.....	220
Double-sided slat wooden panels - for overlaying top plate ..	221

End panel bay

End panel bay.....	222
Components for end panel bay.....	223

CONNECTION ELEMENTS

Wooden back panels.....	224
Steel frame.....	226
Cross frame.....	227

LIGHTING

Book Big lighting.....	228
------------------------	-----

ROUND CONFIGURATIONS

BBN201 - 26° WITH ADJUSTABLE FEET, FOR TOP SHELF	
26° - back frame	232
26° - high steel back panel	236
26° - low steel back panel	240
BBN202 - 26° WITH ADJUSTABLE FEET & TOP PLATE	
26° - back frame - freestanding section	244
26° - back frame - left starter section.....	245
26° - back frame - right starter section	246
26° - back frame - intermediate section	247
26° - back frame - left end section	248
26° - back frame - right end section.....	249
26° - steel back panel - freestanding section	252
26° - steel back panel - left starter section.....	253
26° - steel back panel - right starter section	254
26° - steel back panel - intermediate section	255
26° - steel back panel - left end section	256
26° - steel back panel - right end section.....	257
BBN211 - 26° WITH CASTOR PLATE, FOR TOP SHELF	
26° - back frame - freestanding section	260
26° - high steel back panel - freestanding section	264
26° - low steel back panel - freestanding section	268
BBN212 - 26° WITH CASTOR PLATE & TOP PLATE	
26° - back frame - freestanding section	272
26° - steel back panel - freestanding section	276
BBN221 - 18° WITH ADJUSTABLE FEET, FOR TOP SHELF	
18° - back frame	280
18° - high steel back panel	284
18° - low steel back panel	290
BBN222 - 18° WITH ADJUSTABLE FEET & TOP PLATE	
18° - back frame - freestanding section	292
18° - back frame - left starter section.....	293
18° - back frame - right starter section	294
18° - back frame - intermediate section	295
18° - back frame - left end section	296
18° - back frame - right end section.....	297
18° - steel back panel - freestanding section	300
18° - steel back panel - left starter section.....	301
18° - steel back panel - right starter section	302
18° - steel back panel - intermediate section	303
18° - steel back panel - left end section	304
18° - steel back panel - right end section.....	305
BBN231 - 18° WITH CASTOR PLATE, FOR TOP SHELF	
18° - back frame - freestanding section	308
18° - high steel back panel - freestanding section	312
18° - low steel back panel - freestanding section	316
BBN232 - 18° WITH CASTOR PLATE & TOP PLATE	
18° - back frame - freestanding section	320
18° - steel back panel - freestanding section	324

COMPONENTS FOR ROUND SHELVING

CHECK LIST	327
SHELVES	
S5, S6 - steel shelves	328
W5, W6, W7, W8 - wooden shelves	334
WT5, WT7 - wooden top shelves	340
WO5 - wooden overlaying top plates.....	344
CASTORS & PLINTHS	
Visible castors.....	347
Hidden castors.....	347
Castor plates	348
Plinths.....	349
PANELS	
With adjustable feet/for castor frame:	
Double-sided wooden panels - for top shelf	350
Double-sided wooden panels - for overlaying top plate	352
For castor plate:	
Double-sided wooden panels - for top shelf	354
Double-sided wooden panels - for overlaying top plate	360
End panel bay	
End panel bay	358
Components for end panel bay.....	359
CONNECTION ELEMENTS	
Steel back panels.....	360
Steel frames.....	362



WOOD FROM SUSTAINABLE MANAGED FORESTRY

We are committed to increasing the share of sustainable raw wooden material in our products and thereby support responsibly managed forests – for a better world.

Governments and local authorities are specifying the supply of legal and responsibly sourced wood in their procurement policies.

We have invested in a Chain-of-Custody Multi-site certificate (FSC-C144988), issued by FSC, which documents, that we can offer wood from responsibly managed forests. FSC ® (Forest Stewardship Council) is an international labelling scheme, that documents that FSC labelled products originate from sustainable forestry.

Working with certified suppliers, we can now offer all painted and veneered components as fully FSC Mix certified (noted in this document at the top of each page showing wooden components).



What is sustainable managed forestry?

According to the FSC, forests, managed according to their principles and criteria, mean fair conditions for workers, respect for indigenous communities and local populations as well as strict environmental controls.

The FSC label guarantees that the trees that are harvested are replaced or allowed to regenerate naturally.

The FSC label also guarantees that all the wood is tracked from the forest to the store. Every link between the forest and the consumer is certified to make it clearly identifiable which wood is from sustainable forestry and which is not.

Source: Forest Stewardship Council
<http://www.fsc-uk.org/en-uk>

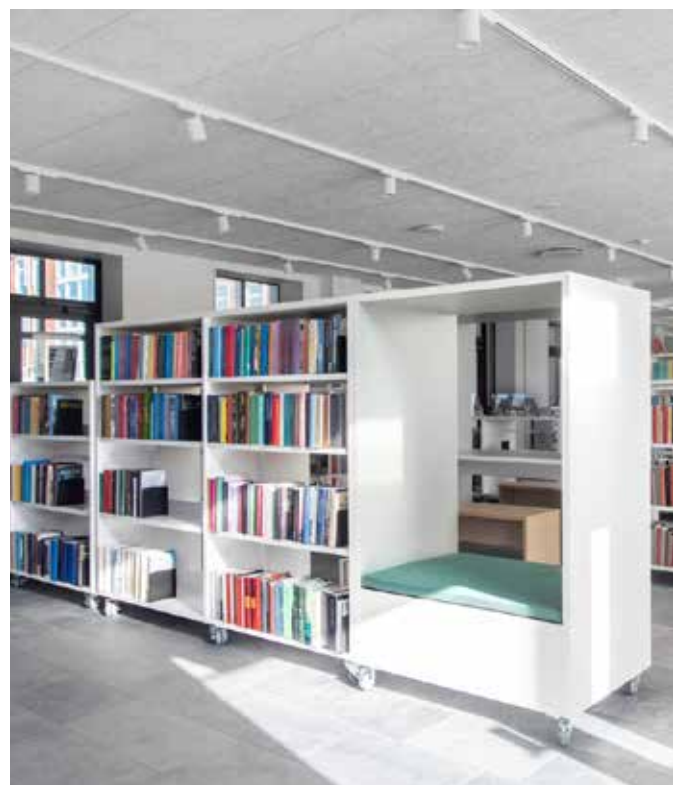

DESIGN OPTIONS

STEEL COMPONENTS - PAINTED

A PRICE GROUP - BASIS PRICE (smooth finish)



A03
Traffic white
RAL 9016
Gloss 75-90



A02
Oyster white
RAL 1013
Gloss 40-50

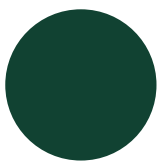

A22
Moss green
RAL 6005
Gloss 71-85



A26
Fir green
RAL 6009
Gloss 71-85

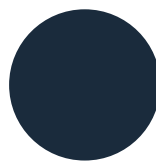

A12
Steel blue
RAL 5011
Gloss 71-85



A13
Light grey
RAL 7035
Gloss 71-85

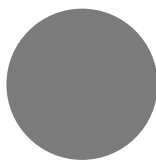

A15
Dusty grey
RAL 7037
Gloss 71-85

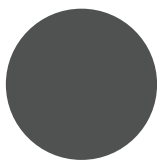

A16
Traffic grey
RAL 7043
Gloss 71-85

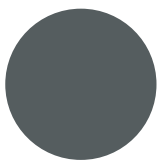

A17
Basalt grey
RAL 7012
Gloss 71-85

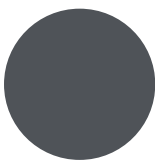

A18
Slate grey
RAL 7015
Gloss 71-85

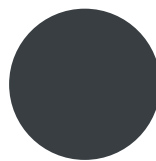

A19
Anthracite grey
RAL 7016
Gloss 71-85

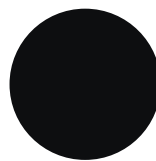

A25
Jet black
RAL 9005
Gloss 71-85

B PRICE GROUP - BASIS PRICE WITH 7% SURCHARGE (smooth finish)



A01
Pure white
RAL 9010
Gloss 71-85

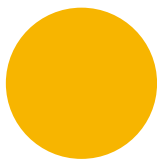

A04
Traffic yellow
RAL 1023
Gloss 71-85

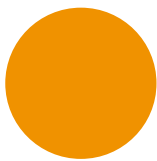

A05
Sun yellow
RAL 1037
Gloss 71-85

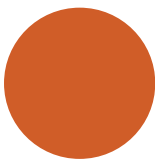

A06
Signal orange
RAL 2010
Gloss 71-85

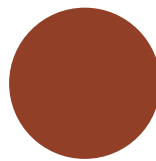

A07
Pearl orange
RAL 2013
Gloss 65-85

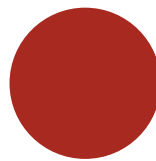

A08
Flame red
RAL 3000
Gloss 71-85



A09
Ruby red
RAL 3003
Gloss 71-85



A21
Reseda green
RAL 6011
Gloss 71-85

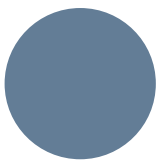

A10
Pigeon blue
RAL 5014
Gloss 71-85

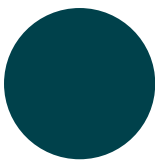

A11
Ocean blue
RAL 5020
Gloss 71-85

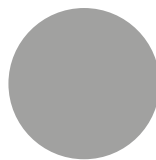

A14
White aluminium
RAL 9006
Gloss 50-70

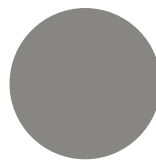

A31
Grey aluminium
RAL 9007
Gloss 50-70

B PRICE GROUP - BASIS PRICE WITH 7% SURCHARGE (textured finish)



A27
Pure white
RAL 9010

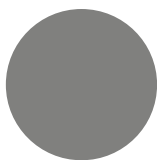

A29
Concertina grey

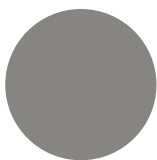

A28
Grey aluminium
RAL 9007



A23
Anthracite grey
RAL 7016

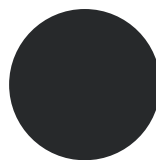

A24
Graphite black
RAL 9011

Note:

- Other RAL/NCS colours have a starter fee of GBP 215 / EUR 250 and a surcharge of 15%. A higher surcharge for colours with "metallic" look or different surface textures must be expected.
- See specific colour for steel gloss specification. Special requests outside specified gloss range are not covered by the above surcharges.
- Chrome, electro galvanised and aluminium parts are not available in other colours.
- Products such as e.g. castors and accurides cannot be produced in other colours than described in the price list.

DESIGN OPTIONS

WOODEN COMPONENTS - MELAMINE/LAMINAT

A PRICE GROUP - BASIS PRICE

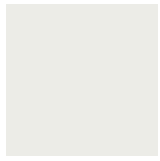

D61/L61
Signal white
RAL 9003

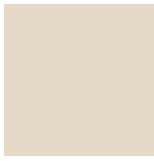

D72/L72
Oyster white
Similar to RAL 1013

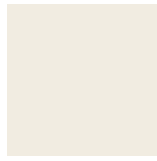

D62/L62
Pure white
Similar to RAL 9010



D63/L63
Steel blue
RAL 5011



D71/L71
Dusty grey
Similar to RAL 7037



D16/L16
Basalt grey
Similar to RAL 7012



D19/L19
Slate grey
Similar to RAL 7015 and
RAL 7016



D04/L04
Beech decor



D05/L05
Maple decor



D06/L06
Cherry decor



D07/L07
Oak decor



D08/L08
Olive decor

C PRICE GROUP - BASIS PRICE WITH 10% SURCHARGE



D64/L64
Signal yellow
RAL 1003



D65/L65
Yellow orange
RAL 2000



D66/L66
Pure orange
RAL 2004



D67/L67
Traffic red
RAL 3020



E02/L02
Ruby red
Similar to RAL 3003



D13/L13
Lime green
Similar to NCS S1060-G40Y



D68/L68
Reseda green
Similar to RAL 6011

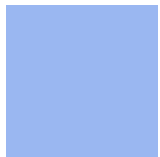

D14/L14
Crystal blue
Similar to NCS S1020-R90B



D73/L73
Pigeon blue
RAL 5014



D74/L74
Ocean blue
Similar to RAL 5020

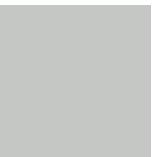

D69/L69
Light grey
Similar to RAL 7035



D70/L70
White aluminium
Similar to RAL 9006



D75/L75
Jet black
Similar to RAL 9005

Note:

- The above selection of colours are shown in both melamine (D/Exx) and laminate (Lxx).
- W3/W4 shelves in L1000 mm will be delivered in laminat.

DESIGN OPTIONS

WOODEN COMPONENTS - PAINTED

A PRICE GROUP - BASIS PRICE

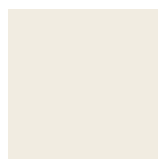

A01
Pure white
RAL 9010
Gloss 20-30



A02
Oyster white
RAL 1013
Gloss 20-30

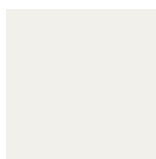

A03
Traffic white
RAL 9016
Gloss 20-30



A04
Traffic yellow
RAL 1023
Gloss 20-30



A05
Sun yellow
RAL 1037
Gloss 20-30



A06
Signal orange
RAL 2010
Gloss 20-30



A07
Pearl orange
RAL 2013
Gloss 20-30



A08
Flame red
RAL 3000
Gloss 20-30



A09
Ruby red
RAL 3003
Gloss 20-30



A21
Reseda green
RAL 6011
Gloss 20-30



A22
Moss green
RAL 6005
Gloss 20-30



A26
Fir green
RAL 6009
Gloss 20-30



A10
Pigeon blue
RAL 5014
Gloss 20-30



A11
Ocean blue
RAL 5020
Gloss 20-30



A12
Steel blue
RAL 5011
Gloss 20-30



A13
Light grey
RAL 7035
Gloss 20-30



A14
White aluminium
RAL 9006
Gloss 20-30



A31
Grey aluminium
RAL 9007
Gloss 20-30



A15
Dusty grey
RAL 7037
Gloss 20-30



A16
Traffic grey
RAL 7043
Gloss 20-30



A17
Basalt grey
RAL 7012
Gloss 20-30



A18
Slate grey
RAL 7015
Gloss 20-30



A19
Anthracite grey
RAL 7016
Gloss 20-30



A25
Jet black
RAL 9005
Gloss 20-30

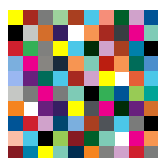

Any RAL/NCS colour
Gloss 20-30

Note:

- The above selection of colours match our steel colours. Note that you can order any RAL/NCS colour without surcharge.
- A surcharge for colours with "metallic" look or different surface textures must be expected, please contact Customer Service.

DESIGN OPTIONS

WOODEN COMPONENTS - VENEER

A PRICE GROUP - BASIS PRICE



55
Light steamed
beech



66
Oak



67
Maple



68
Ash



69
Birch

Note:

- The wooden veneers can also be stained for a surcharge, please contact Customer Service. Samples will be forwarded for approval.

TECHNICAL SPECIFICATIONS

GENERAL SPECIFICATIONS

DIMENSIONS

Dimensions of complete bays in available modules and heights can be found in each catalogue section which include complete configurations. Dimensions of each component can be found under the individual products. All cited measurements are nominal sizes.

MAXIMUM LOAD

The shelving is only intended for use on a flat, even floor without gradient. Before loading the shelving, make sure that the floor is suitable for the weight of the shelving and the stored goods.

The maximum values specified below must be observed.

Maximum area load for Lingo single-sided bay: 480 kg

Maximum area load for Lingo double-sided bay: 960 kg

Maximum area load for Lingo double-sided bay on castor frame with visible/hidden castors: 400 kg

Maximum area load for Lingo double-sided bay on castor plate: 200 kg

Maximum area load for Lingo Square: 600 kg

S1 - Steel shelf with H47 mm steel backedge: 80 kg

S2 - Steel shelf with H17 mm acrylic backedge: 80 kg

S3 - Steel shelf with H25 mm steel backedge: 80 kg

S4 - Steel shelf: 80 kg

S5 - Inner round steel shelf with H47 mm steel backedge: 80 kg

S5 - Outer round steel shelf with H47 mm steel backedge: 80 kg

S6 - Inner round steel shelf: 80 kg

S6 - Outer round steel shelf: 80 kg

ST1 - Steel top shelf: 25 kg

ST2 - Steel top shelf: 80 kg

ST3 - Steel top shelf: 80 kg

S4 - Steel shelf: 80 kg

ST5 - Inner single-sided round steel top shelf H25/47 mm front edge: 25 kg

ST5 - Outer single-sided round steel top shelf H25/47 mm front edge: 25 kg

W1 - Wooden shelf with H47 mm steel backedge: 80 kg

W2 - Wooden shelf: 80 kg

W3 - Wooden shelf with H47 mm steel backedge: 60 kg

W4 - Wooden shelf: 60 kg

W5 - Inner round wooden shelf with H47 mm steel backedge: 80 kg

W5 - Outer round wooden shelf with H47 mm steel backedge: 80 kg

W6 - Inner round wooden shelf: 80 kg

W6 - Outer round wooden shelf: 80 kg

W7 - Inner round wooden shelf with H47 mm steel backedge: 60 kg

W7 - Outer round wooden shelf with H47 mm steel backedge: 60 kg

W8 - Inner round wooden shelf: 60 kg

W8 - Outer round wooden shelf: 60 kg

WT1 - Wooden top shelf: 25 kg

WT3 - Wooden top shelf: 25 kg

WT5 - Inner round wooden top shelf: 25 kg

WT5 - Outer round wooden top shelf: 25 kg

WT7 - Inner round wooden top shelf: 25 kg

WT7 - Outer round wooden top shelf: 25 kg

WO1 - Wooden overlaying top plate: 25 kg

WO5 - Round wooden overlaying top plate: 25 kg

Steel browser with pull-out frame: 40 kg

TECHNICAL SPECIFICATIONS

GENERAL SPECIFICATIONS

BAYS WITH ADJUSTABLE FEET AND TOP SHELVES

They are available as freestanding and intermediate bays.

BAYS WITH ADJUSTABLE FEET AND OVERLAYING TOP PLATES

They are available as starter, intermediate and end sections. You can combine 18°, 26° and straight bays to create the desired complete shelving. For maximum number of combined straight and curved bays that can be constructed in a continuous shelving system, see page xx. The adjustable feet can be adjusted even when the bays are loaded.

BAYS WITH CASTORS

Castors may only be fitted with double-sided bays which do not exceed a maximum height of 1520 mm and a maximum of 3 adjoining bays. Bays on castors are not to be used for transportation. The castors are only fitted in order to move the shelving system around, see instruction below. Crossing doorsteps can be dangerous. After moving the shelving you must lock the brakes. Shelving systems generally have to be moved and placed on a flat, level and horizontal floor.

There is a risk of getting hurt if the shelving system is moved incorrectly. Therefore, the following rules of conduct must be followed:

- It must be ensured that no items can fall off the shelves while moving. If in doubt, then remove items before moving.
- Use a maximum of two people to move the shelving system.
- Make sure to move the shelving system in a smooth movement, avoid jerky movements.
- Only move the shelving system at the ends, do not stand at the long sides of the shelving system during the move.
- To avoid injuries, you must ensure that you always have enough space to the surrounding walls and other furniture.
- If more than one person is involved, be sure to coordinate direction and intention, before actually moving the shelving system.
- Ensure that you only move the shelving system on a flat, level floor with no incline. The floor must be free of any items. Even small parts may cause a sudden blockage of a castor. In this case, the shelving system could tip or damage the floor.
- Before moving, unlock the wheel brakes.
- After moving, lock the wheel brakes.

WEIGHT ON BAYS WITH CASTORS

Visible castors on castor frame are available with and without brakes. We recommend installing at least 2 castors with brakes for one or more adjoining bays. Max. load of 100 kg per visible castor/400 kg per bay.

Hidden castors on castor frame are delivered without brakes, so when shelving is positioned in place, you must adjust the adjustable feet. Max. load of 100 kg per hidden castor/400 kg per bay.

Bays with castor plates are mounted with either 4, 6 or 8 castors, 2 of which are with brakes. Max. load of 200 kg per bay.

BAYS WITH SHELVES

Bays with back panel/back frame: Each bay must have at least 2 shelves (4 shelves for double-sided bays) - top and bottom - screwed into the panels for stability. The remaining shelves can be inserted without screws.

Bays with cross brace: Each bay above H1220 mm must have at least 3 shelves (6 shelves for double-sided bays) - top, middle and bottom - screwed into the panels for stability.

STABILITY

End panels are provided with adjustable feet, except for panels intended for use with castor plates. Single-sided panels are supplied with wall securement and must be fixed to the wall.

ROUNDED EDGES

All storage units and brackets have rounded edges.

TECHNICAL SPECIFICATIONS

GENERAL SPECIFICATIONS

DENSITY

Particle board has a density of 600-700 kg/m³

Block board has a density of 602 kg/m³ (+/- 2 %)

MDF has a density of 700 kg/m³ (+/- 5-7 %)

BROWSERS

Shelvings can be fitted with browsers. Pulling out one or more browsers could cause the shelving to tip. Ensure that the shelving cannot tip by securing shelving. If in doubt, you must fix the shelving to the floor, wall or ceiling.

For safety reasons:

- It is not allowed to load browsers with more than 45 kg.
- Do not use the browsers as a step. The lowest browser must be installed at least 50 cm above the ground. This should ensure that the browser is not used as a step.
- Single-sided bays must be fixed to the wall. A maximum of 3 drawers per bay is allowed.
- Only 1 browser per side and bay is allowed on double-sided bays.
- Do not install pull-out browsers on shelving with castors.

ASSEMBLY

All wooden shelving units come knocked-down. Assembly guidelines can be found on our website.

TECHNICAL SPECIFICATIONS

GENERAL SPECIFICATIONS

BACK FRAME

Straight configurations with steel back frame include the necessary frames depending on height and number of bays. This is to ensure stability. When you order the products as components please note the following:

Single-sided bays

All heights: order one back frame per bay

Double-sided bays

H720/920/1220/H1520: order one back frame per bay

H1820/2120 mm: order based on overview below



1 double-sided bay
=
2 back frames

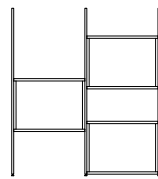

2 double-sided bays
=
3 back frames

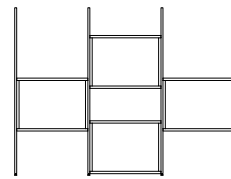

3 double-sided bays
=
4 back frames

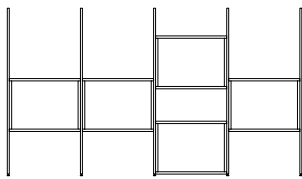

4 double-sided bays
=
5 back frames

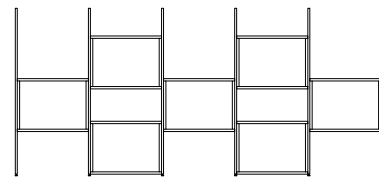

5 double-sided bays
=
7 back frames

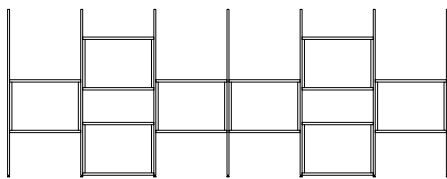

6 double-sided bays
=
8 back frames

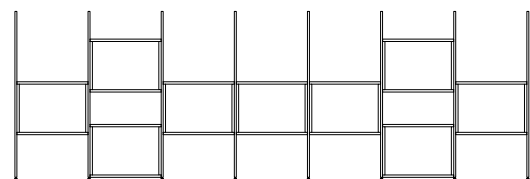

7 double-sided bays
=
9 back frames

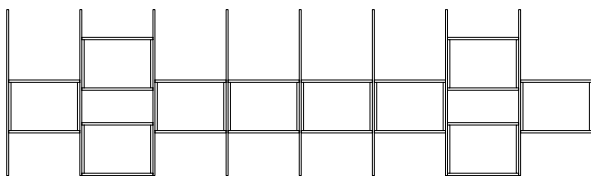

8 double-sided bays
=
10 back frames

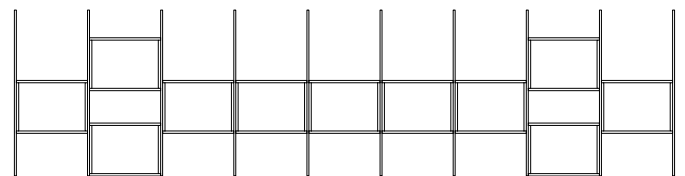

9 double-sided bays
=
11 back frames

TECHNICAL SPECIFICATIONS

STEEL COMPONENTS

STEEL COMPONENTS

are powder coated with standard polyester based powders that secures high UV resistance. Powders comply with EN 45545 (fire protection - similar to DIN 4201). Thickness of the coating is 60-80 μ m.

The powder used includes:

- no azo dyes that can release a leaving carcinogenic amine component
- no triglycidylisocyanurate (TGIC)
- no heavy steel-containing pigments such as lead and cadmium
- no volatiles

Antibacterial equipping of surfaces upon request.

BACK FRAMES

are made of 30 x 20 x 1.5 mm steel tubes. The back frame is easy to assemble between the panels.

CROSS BRACES

are made of galvanized steel \varnothing 4 mm.

BACK PANELS

are made of 0,9 mm steel.

SHELVES AND BROWSERS

are made of 0.9 mm sheet steel. The steel shelves have a H25 mm frontedge, the steel top shelves have a H25/47 mm frontedge.

BRACKETS

are made of 1.4 mm sheet steel.

FRAMES FOR CASTORS

are made of:

visible castors: 40 x 30 x 2 steel tubes. The end plates are made of 2 mm sheet steel.

hidden castors: 30 x 30 x 2. steel tubes. The end plates are made of 2 mm sheet steel, the plinth is made of 0,9 mm sheet steel.

STRAIGHT PLINTHS

are made of 1,4 mm steel.

ROUND PLINTHS

are made of 0,9 mm steel.

TECHNICAL SPECIFICATIONS

WOODEN MELAMINE COMPONENTS

WOODEN MELAMINE COMPONENTS

are made of particle board/block board.

PANELS

are made of 25 mm particle board with a 2 mm ABS border. The panels have two holes in the bottom for adjustable feet except from double-sided intermediate panels above 1220 mm, they have 4 holes for adjustable feet.

END PANELS FOR LINGO SQUARE

are made of 25 mm particle board 2 mm ABS border.

BACK PANELS

are made of 19 mm particle board with a 2 mm ABS border on the horizontal edges.

SHELVES

W3 and W4 (modules 500/750/900) are made of 25 mm particle board with a 2 mm ABS border.

W3 and W4 (module 1000) are made of 25 mm block board and has a laminate finish, except for colour D62, which has a melamin finish.

W7 and W8 are made of 25 mm particle board.

WT3 and WT7 are made of 25 mm particle board with a 2 mm ABS border.

WO1 and WO5 are made of 25 mm particle board with a 2 mm ABS border.

CASTOR PLATES

are made of 25 mm particle board with a 2 mm ABS border.

PLINTHS

are made of 25 mm particle board with a 2 mm ABS border on the horizontal edges.

TECHNICAL SPECIFICATIONS

WOODEN PAINTED COMPONENTS

WOODEN PAINTED COMPONENTS

are made of either particle board (with a paintable foil)/MDF/MDF blockboard, which are painted with acid lacquer. Standard components have gloss 20 - 30. See Design Options for colour specifications.

PANELS

are made of 25 mm particle board or MDF, with a 2 mm paintable ABS border. The panels have two holes in the bottom for adjustable feet, double-sided intermediate panels above 1220 mm have 4 holes for adjustable feet.

DISPLAY END PANELS

are made of 25 mm MDF with a 2 mm paintable ABS border. The panels have two holes in the bottom for adjustable feet.

END PANELS FOR LINGO SQUARE

are made of 25 mm MDF.

BACK PANELS

are made of 19 mm MDF and are painted on all sides and edges.

SHELVES

W1 and W2 are made of 25 mm MDF block board.

W5 and W6 are made of 25 mm MDF block board.

WT1 and WT5 are made of 25 mm particle board or MDF, with a 2 mm paintable ABS border.

WO1 and WO5 are made of 25 mm particle board or MDF, with a 2 mm paintable ABS border.

CASTOR PLATES

are made of 25 mm particle board or MDF with a 2 mm paintable ABS border.

PLINTHS

are made of 25 mm particle board or MDF with a 2 mm paintable ABS border on the horizontal edges.

TECHNICAL SPECIFICATIONS

WOODEN VENEERED COMPONENTS

WOODEN VENEERED COMPONENTS

are mainly lacquered with a environmental-friendly UV transparent lacquered veneer finish.

PANELS

are made of 25 mm particle board and are veneered with 0.6 mm veneer. All edges on the panels have a 2 mm veneer edge. The panels have two holes in the bottom for adjustable feet except from double-sided intermediate panels above 1220 mm, they have 4 holes for adjustable feet.

DISPLAY END PANELS

are made of 25 mm MDF and are veneered with 0.6 mm veneer. All edges have a 2 mm veneer edge. The panels have two holes in the bottom for adjustable feet.

END PANELS FOR LINGO SQUARE

are made of 25 mm particle board and are veneered with 0.6 mm veneer. All edges have a 2 mm veneer edge.

BACK PANELS

are made of 19 mm particle board and are veneered with 0.6 mm veneer. The horizontal edges have a 2 mm veneer edge. The vertical edges are not banded, as they are not exposed after assembly of the back panel.

SHELVES

W1 and W2 are made of 25 mm block board and are veneered with 0.6 mm veneer. The front and back edges have a 2 mm veneer edge.

W5 and W6 are made of 25 mm block board and are veneered with 0.6 mm veneer. The front and back edges have a 2 mm veneer edge.

WT1 and WT5 are made of 25 mm particle board and are veneered with 0.6 mm veneer. The front and back edges have a 2 mm veneer edge.

WO1 and WO5 are made of 25 mm particle board and are veneered with 0.6 mm veneer. All edges on the panels have a 2 mm veneer edge.

CASTOR PLATES

are made of 25 mm particle board and are veneered with 0.6 mm veneer. All edges on the castor plate have a 2 mm veneer edge.

PLINTHS

are made of 25 mm particleboard and are veneered with 0.6 mm veneer on the front. The top and bottom edge have a 2 mm veneer edge.

DIMENSIONS

LINGO SHELVING



The distance between the front edge of the end panel and the front edge of the shelf is 7 mm. The shelves are adjustable in 25 mm increments.

Lingo shelving configurations are delivered as standard based on price group A (melamine coated/painted/veneer), see p. 6-9 for Design Options.

HEIGHTS

Lingo shelving is available in 6 heights; 720, 920, 1220, 1520, 1820 and 2120 mm. Heights shown below are for shelving with adjustable feet/castor frame/castor plate.

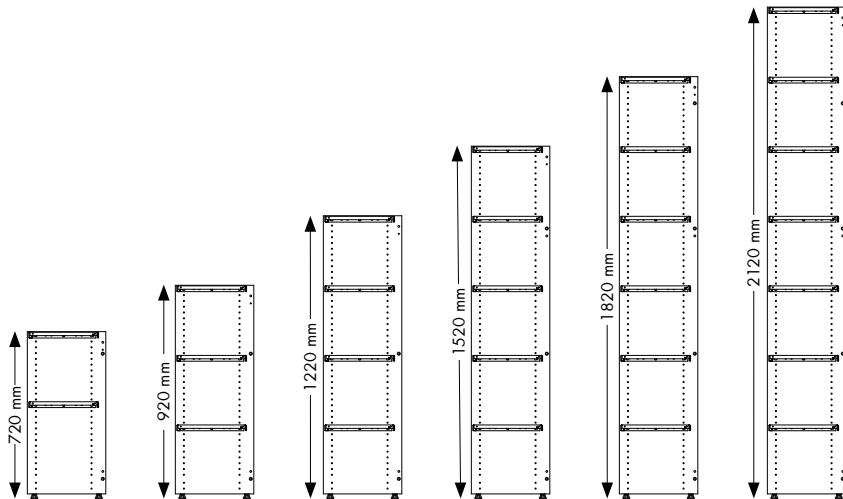

WIDTHS

Lingo shelving is available in 4 widths: 500, 750, 900 and 1000 mm.

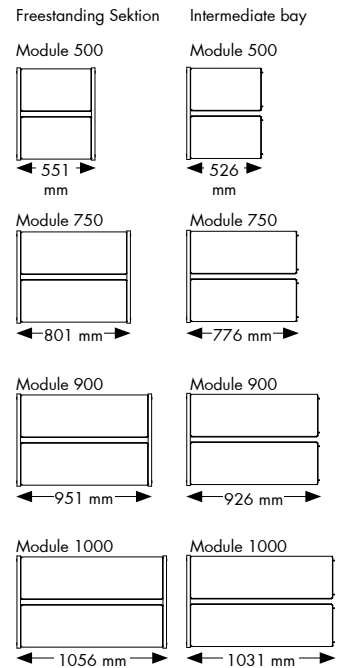

DEPTHS

Lingo shelving is available in 2 x 3 depths: 250, 300 and 400 mm. 2 x 250, 2 x 300 and 2 x 400 mm

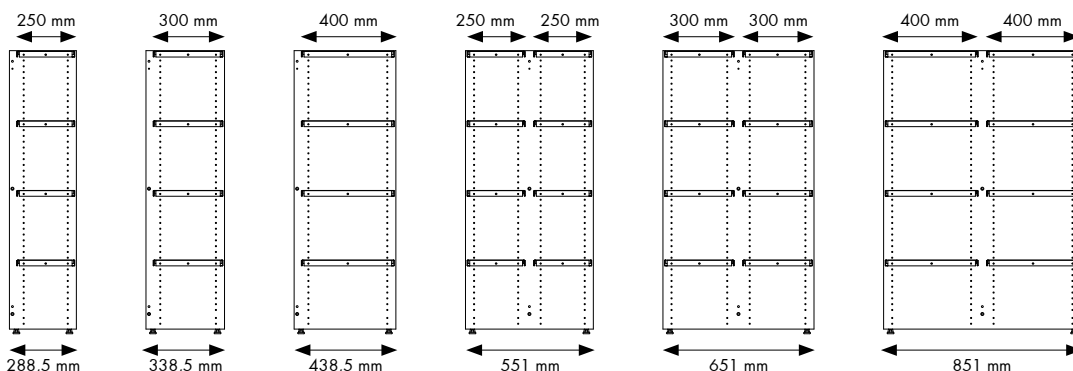

DIMENSIONS

LINGO SQUARE



The distance between the front edge of the end panel and the front edge of the shelf is 7 mm. The shelves are adjustable in 25 mm increments.

Lingo Square configurations are delivered as standard based on price group A (melamine coated/painted/veneer), see p. 6-9 for Design Options.

HEIGHTS

Lingo Square is available in 4 heights: 920, 1220, 1520 and 1820 mm.

Heights shown below are for shelving with adjustable feet/castors.

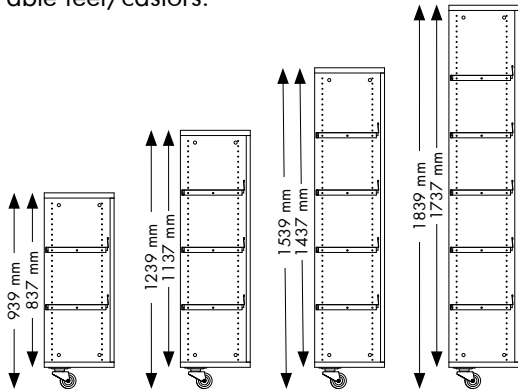

WIDTHS

Lingo Square is available in 3 widths: 500, 750 and 900 mm.

Module 500

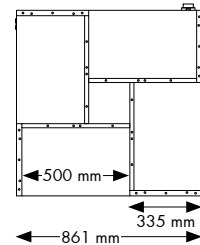
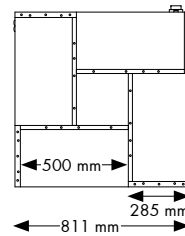

Module 750

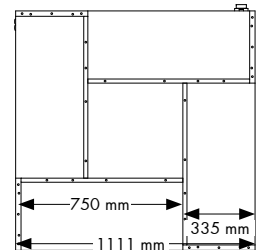
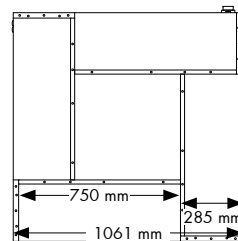

Module 900

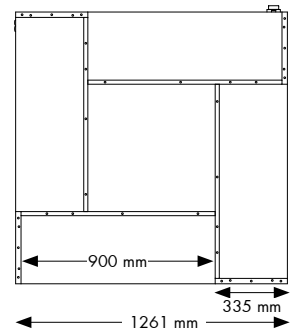
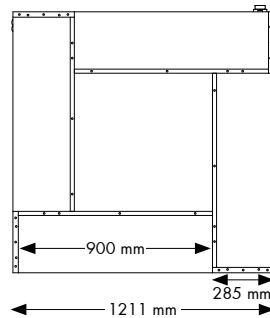

DEPTHS

Lingo Square is available in 2 depths; 250 and 300 mm

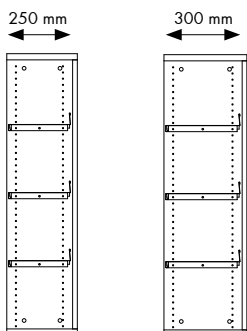

DIMENSIONS

LINGO ROUND SHELVING

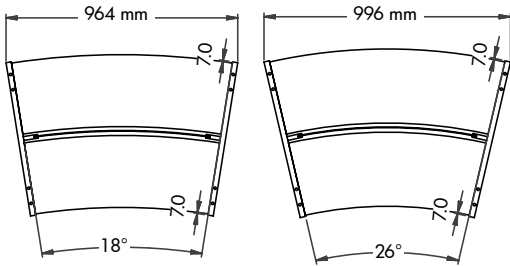

The distance between the front edge of the end panel and the front edge of the shelf is 7 mm. The shelves are adjustable in 25 mm increments.

Lingo Round configurations are delivered as standard based on price group A (melamine coated/painted/veneer), see p. 6-9 for Design Options.

HEIGHTS

Lingo Round shelving is available in 6 heights; 720, 920, 1220, 1520, 1820 and 2120 mm. Heights shown below are for shelving with adjustable feet/castor frame/castor plate.

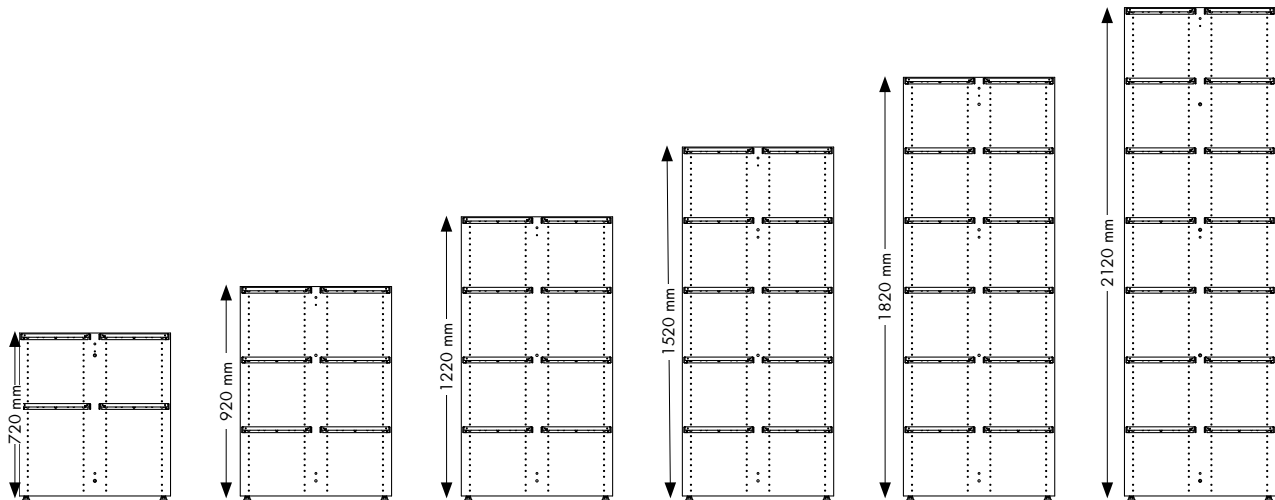

DEPTHS

Lingo Round shelving is available in 1 depth: 2 x 300 mm.

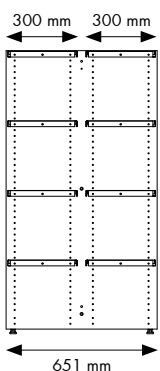

DIMENSIONS

LINGO ROUND SHELVING

LINGO ROUND 26°

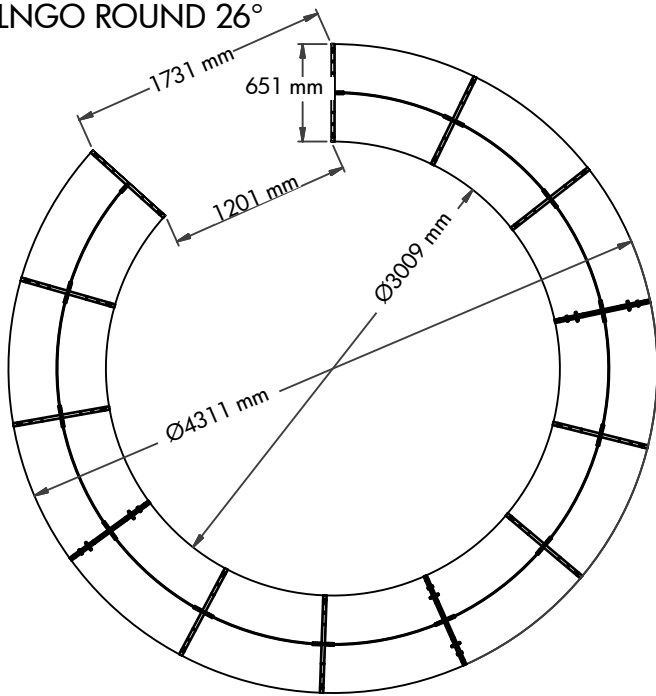

LINGO ROUND 18°

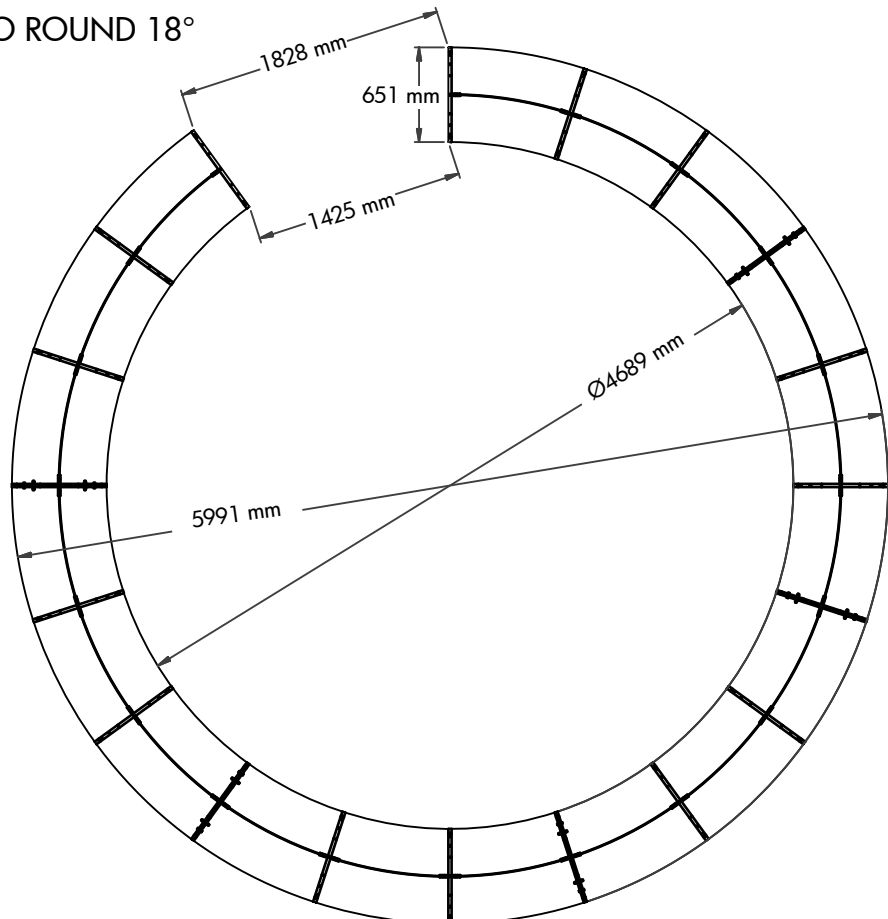

BAY CONSTRUCTION

FREESTANDING AND INTERMEDIATE BAYS BBN001/BBN201/BBN221

A freestanding bay includes one right and one left end panel with holes on the inside of the panel. To add another bay, you must take off the right end panel, insert the intermediate bay (panel with holes on both sides) and fix the right end panel from the freestanding bay to the intermediate bay. See example below and configuration no. 5 on page 29.

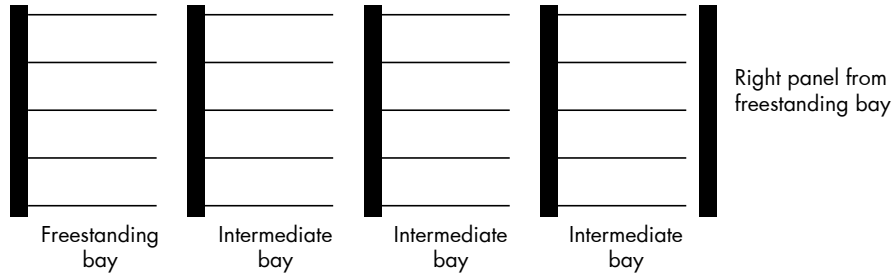

OVERLAYING TOP PLATES FOR STRAIGHT BAYS WITH ADJUSTABLE FEET

A straight overlaying top plate has a maximum length of 2750 mm.

If you build a shelving system with 1, 2 or 3 bays, then you can use just one freestanding top plate (depending on module size).

If you build a shelving system with more than 3 bays, then the overlaying top plates will be a combination of outer and intermediate overlaying top plates.

Freestanding wooden top plate

Is always used for 1 bay and can be used for 1, 2 or 3 bays. The top plate covers the end panels in both ends.

Total width mm				
Module	500	750	900	1000
1 bay	551	801	951	1056
2 bays	1078	1578	1878	2088
3 bays	1604	2354	-	-

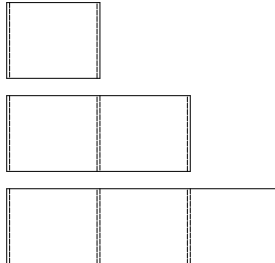

Outer wooden top plate

Can be used for 1, 2 or 3 bays in combination with either outer or intermediate top plates. The top plate covers one end panel.

Total width mm				
Module	500	750	900	1000
1 bay	539	789	939	1044
2 bays	1065	1565	1865	2075
3 bays	1592	2342	-	-

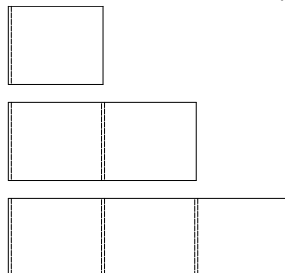

Intermediate wooden top plate

Can be used for 1, 2 or 3 bays in combination with either outer or intermediate top plates. The top plate only covers the intermediate panel.

Total width mm				
Module	500	750	900	1000
1 bay	526	776	926	1031
2 bays	1053	1553	1853	2063
3 bays	1829	2329	-	-

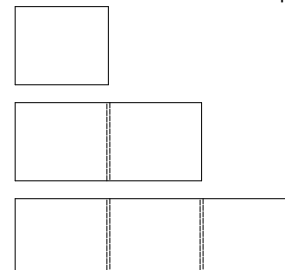

BAY CONSTRUCTION

OVERLAYING TOP PLATES FOR ROUND BAYS WITH ADJUSTABLE FEET

If you build a shelving system with 1, 2 or 3 bays, then you can use just one freestanding top plate.

If you build a shelving system with more than 3 bays, then the overlaying top plates will be a combination of outer and intermediate overlaying top plates.

Freestanding wooden top plate

Is always used for 1 bay and can be used for 1, 2 or 3 bays. The top plate covers the end panels in both ends.

Dimensions mm				
Bay	26°x	26°y	18°x	18°y
1 bay	994	692	962	682
2 bays	1912	809	1875	770
3 bays	2732	994	2742	912

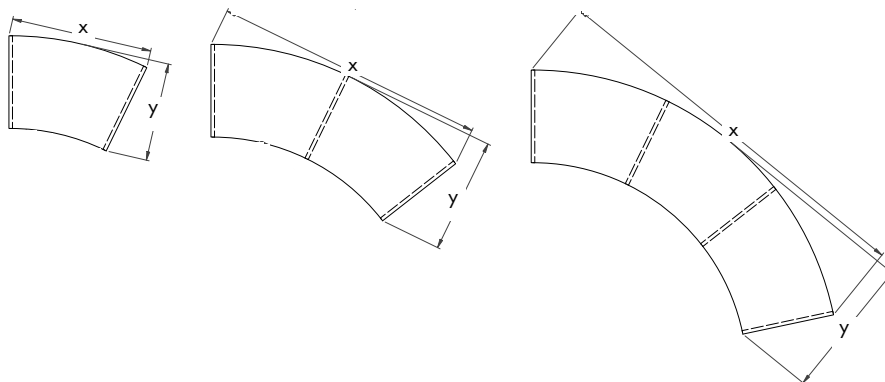

Left/right starter/end wooden top plate

Can be used for 1, 2 or 3 bays in combination with either outer or intermediate top plates. The top plate covers one end panel.

Dimensions mm				
Bay	26°x	26°y	18°x	18°y
1 bay	982	691	951	682
2 bays	1901	806	1861	770
3 bays	2723	990	2731	912

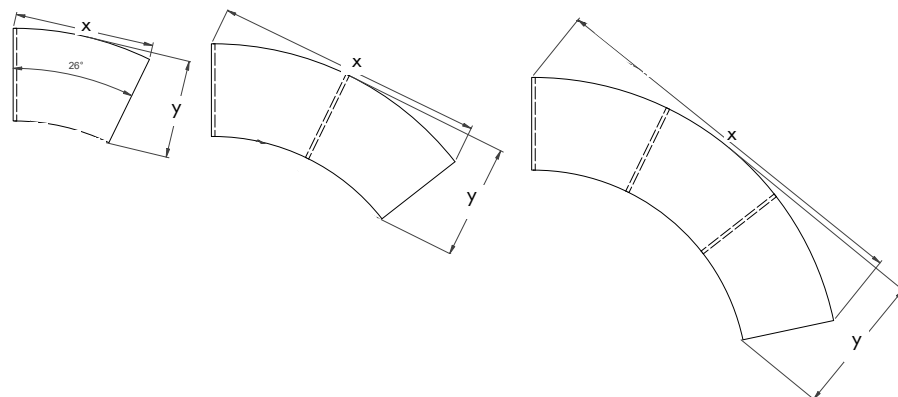

Intermediate wooden top plate

Can be used for 1, 2 or 3 bays in combination with either outer or intermediate top plates. The top plate only covers the intermediate panel.

Dimensions mm				
Bay	26°x	26°y	18°x	18°y
1 bay	982	691	940	677
2 bays	1901	806	1853	765
3 bays	2723	990	2720	907

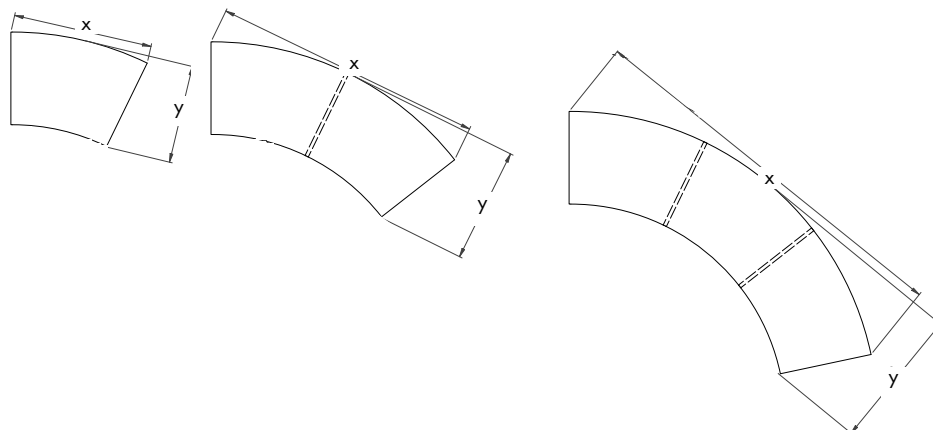

BAY CONSTRUCTION

LEFT/RIGHT STARTER/END ROUND SECTIONS

When constructing a round Lingo shelving system with adjustable feet and top plate (BBN202/BBN222), you must look at the shelving from the inside of the curve to determine which section is needed in the complete shelving system. This means that you will have to change position to find the correct sections to design your final shelving system.

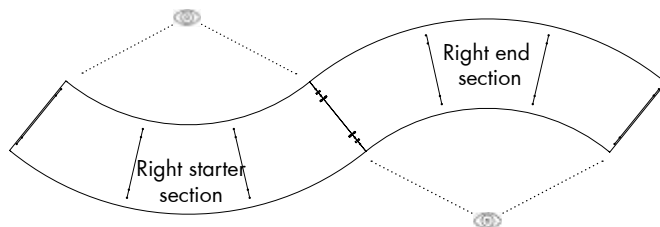
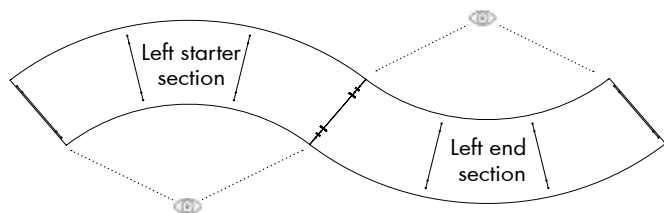

LEFT STARTER SECTION

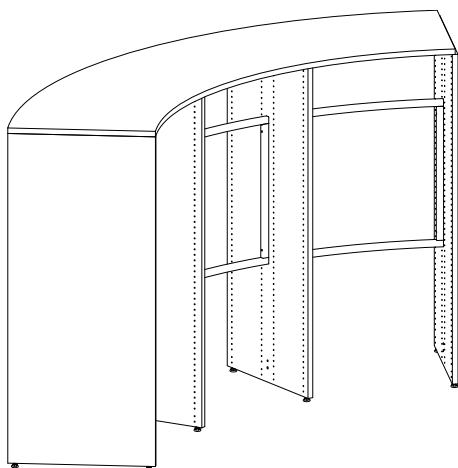

The left starter section starts with a left end panel and ends with an intermediate panel.

RIGHT STARTER SECTION

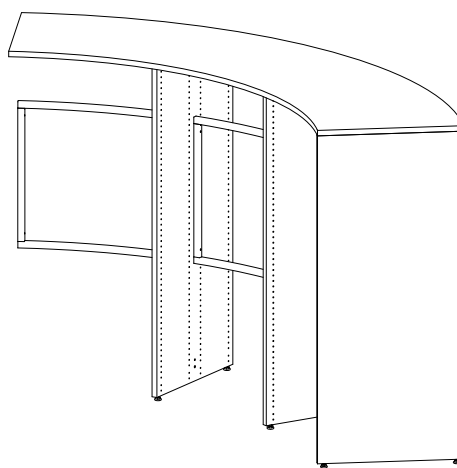

The right starter section starts with a right end panel and ends with an intermediate panel.

LEFT END SECTION

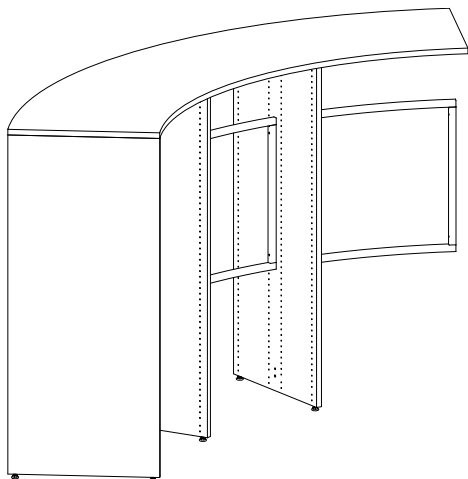

The left end section starts without an intermediate panel and ends with a left end panel.

RIGHT END SECTION

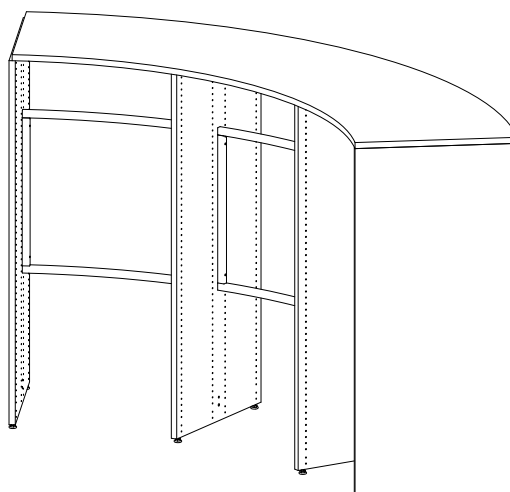

The right end section starts without an intermediate panel and ends with a right end panel.

BAY CONSTRUCTION

INTERMEDIATE SECTIONS

When constructing a round Lingo shelving system with adjustable feet and top plate (BBN202/BBN222) over more than 3 bays, it will be necessary to have an intermediate section in between the starter and end sections.

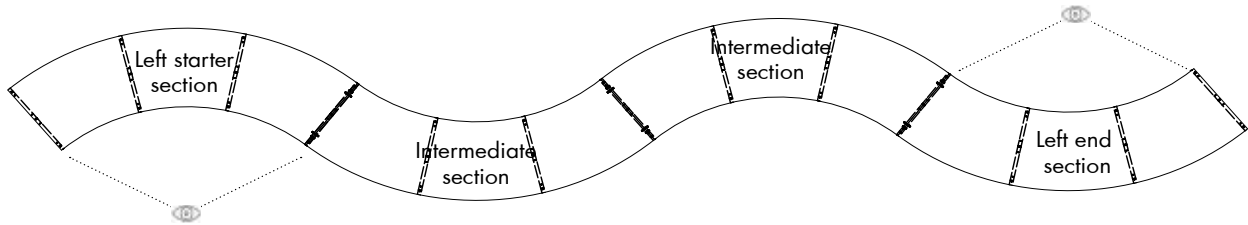

INTERMEDIATE SECTION

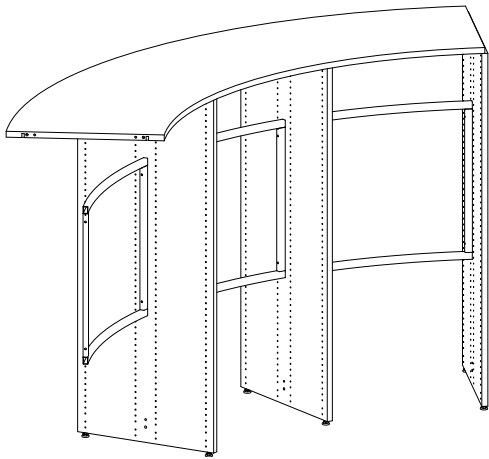

An intermediate section starts without an intermediate panel and ends with an intermediate panel.

STRAIGHT AND ROUND COMBINATIONS

COMBINING STRAIGHT AND ROUND SHELVING

It is possible to combine round and straight shelving to create unique shelving - all depending on space available on location, shelving space required and design.

BAYS ON ADJUSTABLE FEET

There are restrictions to be considered when constructing round shelving, due to the angle of the complete number of bays. The overview shows the maximum number of bays that can be constructed in a continuous shelving system, before you must change the angle/direction of the shelving.

	Number of adjoining bays possible in freestanding section	Number of adjoining bays possible in left/right starter section	Number of adjoining bays possible in intermediate section	Number of adjoining bays possible in left/right end section
26°	Up to 12 bays	Total of 9 bays	7 bays	Total of 9 bays
18°	Up to 18 bays	Total of 13 bays	10 bays	Total of 13 bays
Straight	Up to 9 bays	Total of 9 bays	9 bays	Total of 9 bays

BAYS ON CASTOR PLATE

The overview above also applies to bays on castor plates, however castor plates are constructed in a maximum of 3 bays and not in a continuous shelving system.

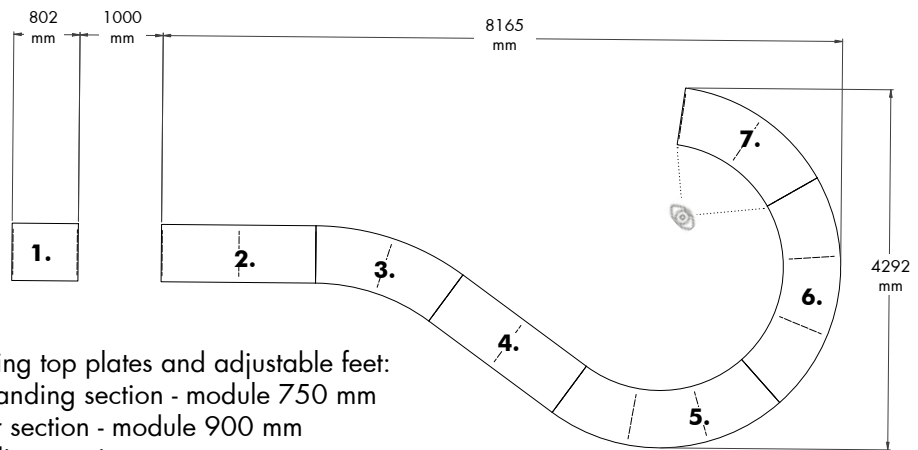

CONFIGURATION NO. 1

Consists of 15 bays with 7 overlaying top plates and adjustable feet:

- 1: BBN002 - 1 bay - straight freestanding section - module 750 mm
- 2: BBN002 - 2 bays - straight outer section - module 900 mm
- 3: BBN222 - 2 bays - 18° intermediate section
- 4: BBN002 - 2 bays - straight intermediate section - module 900 mm
- 5: BBN202 - 3 bays - 26° intermediate section
- 6: BBN202 - 3 bays - 26° intermediate section
- 7: BBN202 - 2 bays - 26° left end section

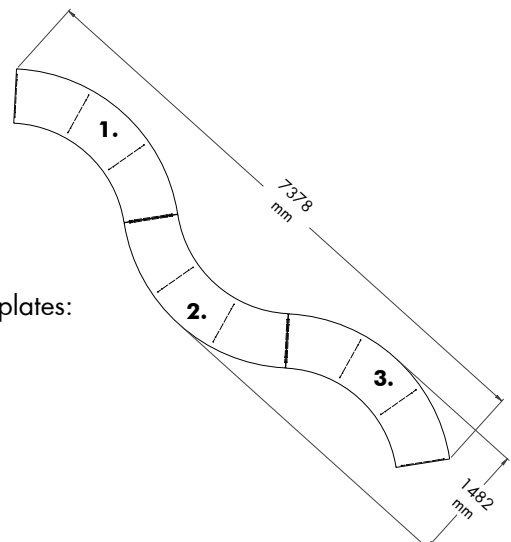

CONFIGURATION NO. 2

Consists of 9 bays with 3 overlaying top plates and 3 castor plates:

- 1: BBN212 - 3 bays - 26° freestanding section
- 2: BBN212 - 3 bays - 26° freestanding section
- 3: BBN212 - 3 bays - 26° freestanding section

STRAIGHT AND ROUND COMBINATIONS

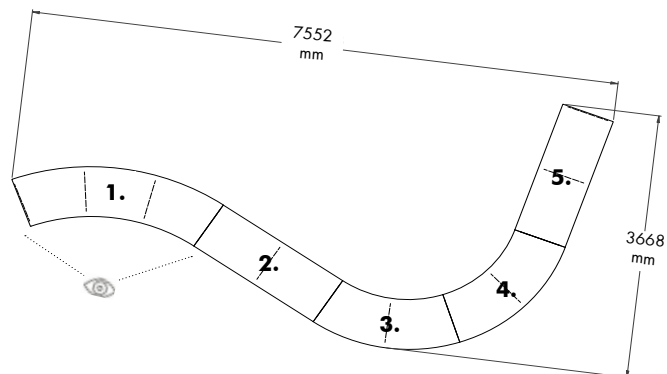

CONFIGURATION NO. 3

Consists of 11 bays with 5 overlaying top plates and adjustable feet:

- 1: BBN222 - 3 bays - 18° left starter section
- 2: BBN002 - 2 bays - straight intermediate section - module 900 mm
- 3: BBN202 - 2 bays - 26° intermediate section
- 4: BBN202 - 2 bays - 26° intermediate section
- 5: BBN002 - 2 bays - straight outer section - module 900 mm

CONFIGURATION NO. 4

Consists of 15 bays with 5 overlaying top plates and 5 castor plates:

- 1: BBN232 - 3 bays - 18° freestanding section
- 2: BBN232 - 3 bays - 18° freestanding section
- 3: BBN232 - 3 bays - 18° freestanding section
- 4: BBN232 - 3 bays - 18° freestanding section
- 5: BBN232 - 3 bays - 18° freestanding section

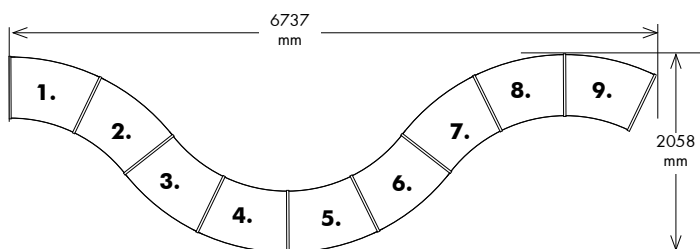
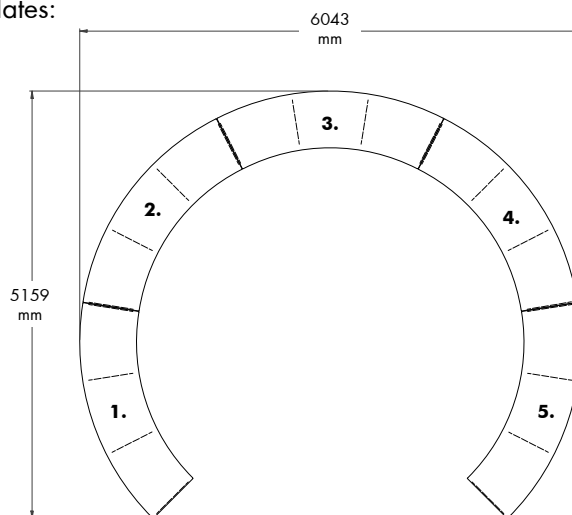

CONFIGURATION NO. 5

Consists of 9 bays with wooden top shelves and adjustable feet:

- 1: BBN201 - 1 bay - 26° freestanding
- 2-9: BBN201 - 8 bays - 26° intermediate

LINGO SHELVING SYSTEM

BBN001 - STEEL BACK FRAME - ADJUSTABLE FEET - FOR TOP SHELF



LINGO SHELVING SYSTEM

BBN001 - STEEL BACK FRAME - ADJUSTABLE FEET - FOR TOP SHELF

Shelving system with wooden panels and steel back frame. To be used with top shelf.
Freestanding bay includes 2 outer panels and 1 or 2 steel back frame depending on height.
Intermediate bay includes 1 intermediate panel and 1 steel back frame.

- Prices based on steel price group 1 and wooden price group A (see Design Options pages 6-9).
- For top shelves, see pages 156 & 174
- For shelves see page 144 & 166.
- For accessories see page 186.

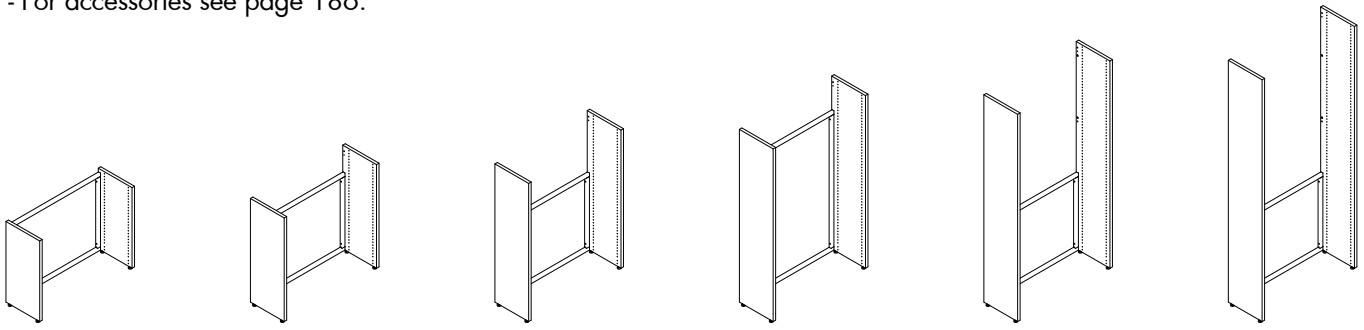

Single-sided freestanding bay - H720/920/1220/1520/1820/2120 mm

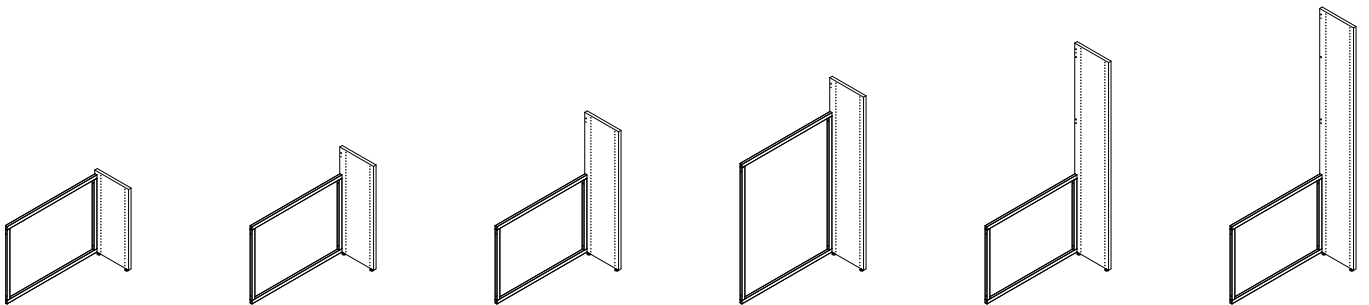

Single-sided intermediate bay - H720/920/1220/1520/1820/2120 mm

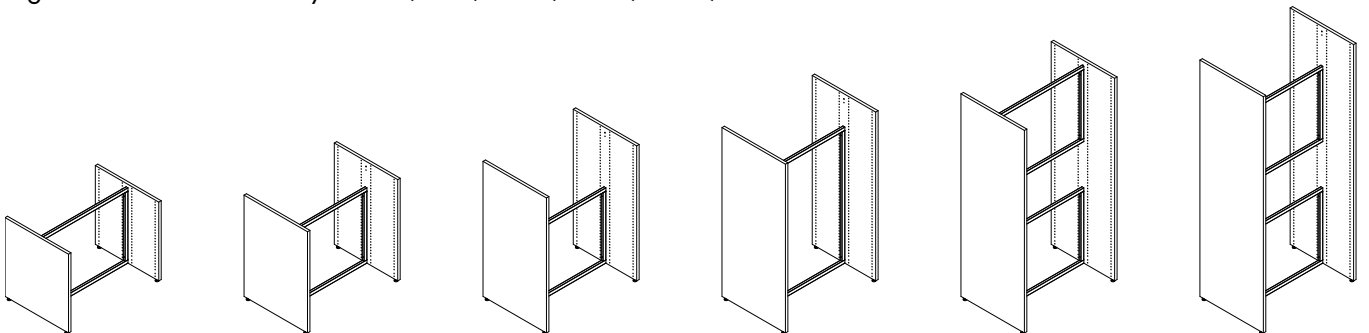

Double-sided freestanding bay - H720/920/1220/1520/1820/2120 mm

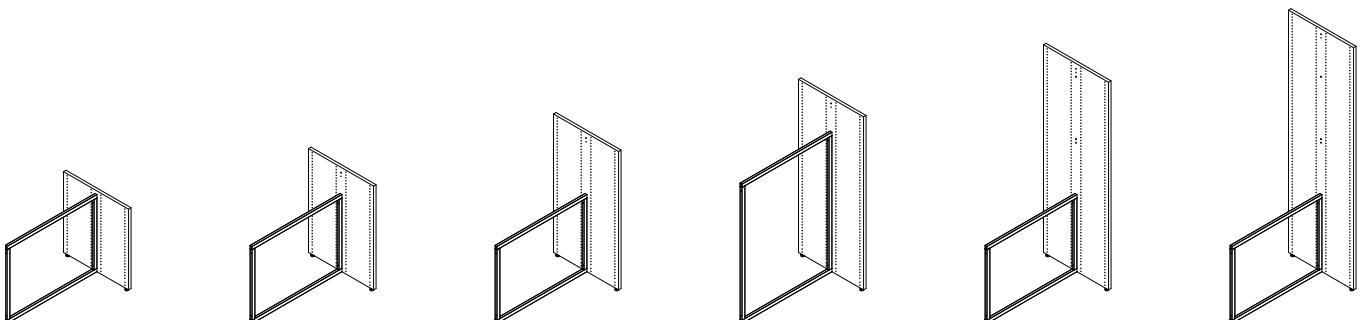

Double-sided intermediate bay - H720/920/1220/1520/1820/2120 mm

LINGO SHELVING SYSTEM

SINGLE-SIDED - STEEL BACK FRAME - ADJUSTABLE FEET - FOR TOP SHELF

Painted and veneered Lingo Shelving Systems are FSC-certified.

H720 mm

Module mm	Shelf depth mm	Item no. Freestanding bay	Melamine EUR	Painted EUR	Veneer EUR	Item no. Intermediate bay	Melamine EUR	Painted EUR	Veneer EUR
500	250	BBN001235510160000.	333,10	378,50	499,10	BBN001235320160000.	205,70	228,40	288,70
500	300	BBN001255510160000.	370,30	421,50	559,70	BBN001255320160000.	224,30	249,90	319,00
500	400	BBN001275510160000.	474,10	544,10	730,50	BBN001275320160000.	276,20	311,20	404,40
750	250	BBN001237510160000.	333,10	378,50	499,10	BBN001237320160000.	205,70	228,40	288,70
750	300	BBN001257510160000.	370,30	421,50	559,70	BBN001257320160000.	224,30	249,90	319,00
750	400	BBN001277510160000.	474,10	544,10	730,50	BBN001277320160000.	276,20	311,20	404,40
900	250	BBN001239510160000.	333,10	378,50	499,10	BBN001239320160000.	205,70	228,40	288,70
900	300	BBN001259510160000.	370,30	421,50	559,70	BBN001259320160000.	224,30	249,90	319,00
900	400	BBN001279510160000.	474,10	544,10	730,50	BBN001279320160000.	276,20	311,20	404,40
1000	250	BBN001231510160000.	343,60	389,00	509,60	BBN001231320160000.	216,20	238,90	299,20
1000	300	BBN001251510160000.	380,80	432,00	570,20	BBN001251320160000.	234,80	260,40	329,50
1000	400	BBN001271510160000.	484,60	554,60	741,00	BBN001271320160000.	286,70	321,70	414,90

H920 mm

Module mm	Shelf depth mm	Item no. Freestanding bay	Melamine EUR	Painted EUR	Veneer EUR	Item no. Intermediate bay	Melamine EUR	Painted EUR	Veneer EUR
500	250	BBN001335510160000.	404,70	462,50	615,30	BBN001335320160000.	241,50	270,40	346,80
500	300	BBN001355510160000.	451,90	517,50	693,90	BBN001355320160000.	265,10	297,90	386,10
500	400	BBN001375510160000.	584,30	673,10	911,50	BBN001375320160000.	331,30	375,70	494,90
750	250	BBN001337510160000.	404,70	462,50	615,30	BBN001337320160000.	241,50	270,40	346,80
750	300	BBN001357510160000.	451,90	517,50	693,90	BBN001357320160000.	265,10	297,90	386,10
750	400	BBN001377510160000.	584,30	673,10	911,50	BBN001377320160000.	331,30	375,70	494,90
900	250	BBN001339510160000.	404,70	462,50	615,30	BBN001339320160000.	241,50	270,40	346,80
900	300	BBN001359510160000.	451,90	517,50	693,90	BBN001359320160000.	265,10	297,90	386,10
900	400	BBN001379510160000.	584,30	673,10	911,50	BBN001379320160000.	331,30	375,70	494,90
1000	250	BBN001331510160000.	415,20	473,00	625,80	BBN001331320160000.	252,00	280,90	357,30
1000	300	BBN001351510160000.	462,40	528,00	704,40	BBN001351320160000.	275,60	308,40	396,60
1000	400	BBN001371510160000.	594,80	683,60	922,00	BBN001371320160000.	341,80	386,20	505,40

H1220 mm

Module mm	Shelf depth mm	Item no. Freestanding bay	Melamine EUR	Painted EUR	Veneer EUR	Item no. Intermediate bay	Melamine EUR	Painted EUR	Veneer EUR
500	250	BBN001435510160000.	510,50	586,30	790,30	BBN001435320160000.	294,40	332,30	434,30
500	300	BBN001455510160000.	529,30	608,70	820,50	BBN001455320160000.	303,80	343,50	449,40
500	400	BBN001475510160000.	732,50	848,10	1.155,70	BBN001475320160000.	405,40	463,20	617,00
750	250	BBN001437510160000.	510,50	586,30	790,30	BBN001437320160000.	294,40	332,30	434,30
750	300	BBN001457510160000.	529,30	608,70	820,50	BBN001457320160000.	303,80	343,50	449,40
750	400	BBN001477510160000.	732,50	848,10	1.155,70	BBN001477320160000.	405,40	463,20	617,00
900	250	BBN001439510160000.	510,50	586,30	790,30	BBN001439320160000.	294,40	332,30	434,30
900	300	BBN001459510160000.	529,30	608,70	820,50	BBN001459320160000.	303,80	343,50	449,40
900	400	BBN001479510160000.	732,50	848,10	1.155,70	BBN001479320160000.	405,40	463,20	617,00
1000	250	BBN001431510160000.	521,00	596,80	800,80	BBN001431320160000.	304,90	342,80	444,80
1000	300	BBN001451510160000.	539,80	619,20	831,00	BBN001451320160000.	314,30	354,00	459,90
1000	400	BBN001471510160000.	743,00	858,60	1.166,20	BBN001471320160000.	415,90	473,70	627,50

LINGO SHELVING SYSTEM

SINGLE-SIDED - STEEL BACK FRAME - ADJUSTABLE FEET - FOR TOP SHELF

Painted and veneered Lingo Shelving Systems are FSC-certified.

H1520 mm

Module mm	Shelf depth mm	Item no. Freestanding bay	Melamine EUR	Painted EUR	Veneer EUR	Item no. Intermediate bay	Melamine EUR	Painted EUR	Veneer EUR
500	250	BBN001535510160000.	593,00	679,80	910,80	BBN001535320160000.	347,40	390,80	506,30
500	300	BBN001555510160000.	611,40	702,00	940,80	BBN001555320160000.	356,60	401,90	521,30
500	400	BBN001575510160000.	856,00	989,00	1.343,00	BBN001575320160000.	478,90	545,40	722,40
750	250	BBN001537510160000.	593,00	679,80	910,80	BBN001537320160000.	347,40	390,80	506,30
750	300	BBN001557510160000.	611,40	702,00	940,80	BBN001557320160000.	356,60	401,90	521,30
750	400	BBN001577510160000.	856,00	989,00	1.343,00	BBN001577320160000.	478,90	545,40	722,40
900	250	BBN001539510160000.	593,00	679,80	910,80	BBN001539320160000.	347,40	390,80	506,30
900	300	BBN001559510160000.	611,40	702,00	940,80	BBN001559320160000.	356,60	401,90	521,30
900	400	BBN001579510160000.	856,00	989,00	1.343,00	BBN001579320160000.	478,90	545,40	722,40
1000	250	BBN001531510160000.	606,30	693,10	924,10	BBN001531320160000.	360,70	404,10	519,60
1000	300	BBN001551510160000.	624,70	715,30	954,10	BBN001551320160000.	369,90	415,20	534,60
1000	400	BBN001571510160000.	869,30	1.002,30	1.356,30	BBN001571320160000.	492,20	558,70	735,70

H1820 mm

Module mm	Shelf depth mm	Item no. Freestanding bay	Melamine EUR	Painted EUR	Veneer EUR	Item no. Intermediate bay	Melamine EUR	Painted EUR	Veneer EUR
500	250	BBN001635510160000.	654,30	755,90	1.027,10	BBN001635320160000.	366,30	417,10	552,70
500	300	BBN001655510160000.	667,70	771,90	1.048,30	BBN001655320160000.	373,00	425,10	563,30
500	400	BBN001675510160000.	941,10	1.093,30	1.500,10	BBN001675320160000.	509,70	585,80	789,20
750	250	BBN001637510160000.	654,30	755,90	1.027,10	BBN001637320160000.	366,30	417,10	552,70
750	300	BBN001657510160000.	667,70	771,90	1.048,30	BBN001657320160000.	373,00	425,10	563,30
750	400	BBN001677510160000.	941,10	1.093,30	1.500,10	BBN001677320160000.	509,70	585,80	789,20
900	250	BBN001639510160000.	654,30	755,90	1.027,10	BBN001639320160000.	366,30	417,10	552,70
900	300	BBN001659510160000.	667,70	771,90	1.048,30	BBN001659320160000.	373,00	425,10	563,30
900	400	BBN001679510160000.	941,10	1.093,30	1.500,10	BBN001679320160000.	509,70	585,80	789,20
1000	250	BBN001631510160000.	664,80	766,40	1.037,60	BBN001631320160000.	376,80	427,60	563,20
1000	300	BBN001651510160000.	678,20	782,40	1.058,80	BBN001651320160000.	383,50	435,60	573,80
1000	400	BBN001671510160000.	951,60	1.103,80	1.510,60	BBN001671320160000.	520,20	596,30	799,70

H2120 mm

Module mm	Shelf depth mm	Item no. Freestanding bay	Melamine EUR	Painted EUR	Veneer EUR	Item no. Intermediate bay	Melamine EUR	Painted EUR	Veneer EUR
500	250	BBN001735510160000.	720,30	833,70	1.135,90	BBN001735320160000.	399,30	456,00	607,10
500	300	BBN001755510160000.	732,50	848,10	1.155,70	BBN001755320160000.	405,40	463,20	617,00
500	400	BBN001775510160000.	1.024,90	1.192,10	1.636,90	BBN001775320160000.	551,60	635,20	857,60
750	250	BBN001737510160000.	720,30	833,70	1.135,90	BBN001737320160000.	399,30	456,00	607,10
750	300	BBN001757510160000.	732,50	848,10	1.155,70	BBN001757320160000.	405,40	463,20	617,00
750	400	BBN001777510160000.	1.024,90	1.192,10	1.636,90	BBN001777320160000.	551,60	635,20	857,60
900	250	BBN001739510160000.	720,30	833,70	1.135,90	BBN001739320160000.	399,30	456,00	607,10
900	300	BBN001759510160000.	732,50	848,10	1.155,70	BBN001759320160000.	405,40	463,20	617,00
900	400	BBN001779510160000.	1.024,90	1.192,10	1.636,90	BBN001779320160000.	551,60	635,20	857,60
1000	250	BBN001731510160000.	730,80	844,20	1.146,40	BBN001731320160000.	409,80	466,50	617,60
1000	300	BBN001751510160000.	743,00	858,60	1.166,20	BBN001751320160000.	415,90	473,70	627,50
1000	400	BBN001771510160000.	1.035,40	1.202,60	1.647,40	BBN001771320160000.	562,10	645,70	868,10

LINGO SHELVING SYSTEM

DOUBLE-SIDED - STEEL BACK FRAME - ADJUSTABLE FEET - FOR TOP SHELF

Painted and veneered Lingo Shelving Systems are FSC-certified.

H720 mm

Module mm	Shelf depth mm	Item no. Freestanding bay	Melamine EUR	Painted EUR	Veneer EUR	Item no. Intermediate bay	Melamine EUR	Painted EUR	Veneer EUR
500	250	BBN001245510160000.	451,10	516,70	691,90	BBN001245320160000.	264,70	297,50	385,10
500	300	BBN001265510160000.	567,50	653,50	920,90	BBN001265320160000.	322,90	365,90	481,20
500	400	BBN001285510160000.	789,10	914,30	1.249,10	BBN001285320160000.	433,70	496,30	663,70
750	250	BBN001247510160000.	451,10	516,70	691,90	BBN001247320160000.	264,70	297,50	385,10
750	300	BBN001267510160000.	567,50	653,50	920,90	BBN001267320160000.	322,90	365,90	481,20
750	400	BBN001287510160000.	789,10	914,30	1.249,10	BBN001287320160000.	433,70	496,30	663,70
900	250	BBN001249510160000.	451,10	516,70	691,90	BBN001249320160000.	264,70	297,50	385,10
900	300	BBN001269510160000.	567,50	653,50	920,90	BBN001269320160000.	322,90	365,90	481,20
900	400	BBN001289510160000.	789,10	914,30	1.249,10	BBN001289320160000.	433,70	496,30	663,70
1000	250	BBN001241510160000.	461,60	527,20	702,40	BBN001241320160000.	275,20	308,00	395,60
1000	300	BBN001261510160000.	578,00	664,00	931,40	BBN001261320160000.	333,40	376,40	491,70
1000	400	BBN001281510160000.	799,60	924,80	1.259,60	BBN001281320160000.	444,20	506,80	674,20

H920 mm

Module mm	Shelf depth mm	Item no. Freestanding bay	Melamine EUR	Painted EUR	Veneer EUR	Item no. Intermediate bay	Melamine EUR	Painted EUR	Veneer EUR
500	250	BBN001345510160000.	554,30	638,30	862,30	BBN001345320160000.	316,30	358,30	470,30
500	300	BBN001365510160000.	703,50	814,10	1.108,50	BBN001365320160000.	390,90	446,20	593,40
500	400	BBN001385510160000.	986,50	1.146,30	1.573,50	BBN001385320160000.	532,40	612,30	825,90
750	250	BBN001347510160000.	554,30	638,30	862,30	BBN001347320160000.	316,30	358,30	470,30
750	300	BBN001367510160000.	703,50	814,10	1.108,50	BBN001367320160000.	390,90	446,20	593,40
750	400	BBN001387510160000.	986,50	1.146,30	1.573,50	BBN001387320160000.	532,40	612,30	825,90
900	250	BBN001349510160000.	554,30	638,30	862,30	BBN001349320160000.	316,30	358,30	470,30
900	300	BBN001369510160000.	703,50	814,10	1.108,50	BBN001369320160000.	390,90	446,20	593,40
900	400	BBN001389510160000.	986,50	1.146,30	1.573,50	BBN001389320160000.	532,40	612,30	825,90
1000	250	BBN001341510160000.	564,80	648,80	872,80	BBN001341320160000.	326,80	368,80	480,80
1000	300	BBN001361510160000.	714,00	824,60	1.119,00	BBN001361320160000.	401,40	456,70	603,90
1000	400	BBN001381510160000.	997,00	1.156,80	1.584,00	BBN001381320160000.	542,90	622,80	836,40

H1220 mm

Module mm	Shelf depth mm	Item no. Freestanding bay	Melamine EUR	Painted EUR	Veneer EUR	Item no. Intermediate bay	Melamine EUR	Painted EUR	Veneer EUR
500	250	BBN001445510160000.	706,30	817,30	1.113,50	BBN001445320160000.	392,30	447,80	595,90
500	300	BBN001465510160000.	890,70	1.033,90	1.417,10	BBN001465320160000.	484,50	556,10	747,70
500	400	BBN001485510160000.	1.258,90	1.467,30	2.023,70	BBN001485320160000.	668,60	772,80	1.051,00
750	250	BBN001447510160000.	706,30	817,30	1.113,50	BBN001447320160000.	392,30	447,80	595,90
750	300	BBN001467510160000.	890,70	1.033,90	1.417,10	BBN001467320160000.	484,50	556,10	747,70
750	400	BBN001487510160000.	1.258,90	1.467,30	2.023,70	BBN001487320160000.	668,60	772,80	1.051,00
900	250	BBN001449510160000.	706,30	817,30	1.113,50	BBN001449320160000.	392,30	447,80	595,90
900	300	BBN001469510160000.	890,70	1.033,90	1.417,10	BBN001469320160000.	484,50	556,10	747,70
900	400	BBN001489510160000.	1.258,90	1.467,30	2.023,70	BBN001489320160000.	668,60	772,80	1.051,00
1000	250	BBN001441510160000.	716,80	827,80	1.124,00	BBN001441320160000.	402,80	458,30	606,40
1000	300	BBN001461510160000.	901,20	1.044,40	1.427,60	BBN001461320160000.	495,00	566,60	758,20
1000	400	BBN001481510160000.	1.269,40	1.477,80	2.034,20	BBN001481320160000.	679,10	783,30	1.061,50

LINGO SHELVING SYSTEM

DOUBLE-SIDED - STEEL BACK FRAME - ADJUSTABLE FEET - FOR TOP SHELF

Painted and veneered Lingo Shelving Systems are FSC-certified.

H1520 mm

Module mm	Shelf depth mm	Item no. Freestanding bay	Melamine EUR	Painted EUR	Veneer EUR	Item no. Intermediate bay	Melamine EUR	Painted EUR	Veneer EUR
500	250	BBN001545510160000.	803,20	926,80	1.256,20	BBN001545320160000.	452,50	514,30	679,00
500	300	BBN001565510160000.	957,60	1.108,60	1.512,20	BBN001565320160000.	529,70	605,20	807,00
500	400	BBN001585510160000.	1.344,60	1.564,20	2.149,20	BBN001585320160000.	723,20	833,00	1.125,50
750	250	BBN001547510160000.	803,20	926,80	1.256,20	BBN001547320160000.	452,50	514,30	679,00
750	300	BBN001567510160000.	957,60	1.108,60	1.512,20	BBN001567320160000.	529,70	605,20	807,00
750	400	BBN001587510160000.	1.344,60	1.564,20	2.149,20	BBN001587320160000.	723,20	833,00	1.125,50
900	250	BBN001549510160000.	803,20	926,80	1.256,20	BBN001549320160000.	452,50	514,30	679,00
900	300	BBN001569510160000.	957,60	1.108,60	1.512,20	BBN001569320160000.	529,70	605,20	807,00
900	400	BBN001589510160000.	1.344,60	1.564,20	2.149,20	BBN001589320160000.	723,20	833,00	1.125,50
1000	250	BBN001541510160000.	816,50	940,10	1.269,50	BBN001541320160000.	465,80	527,60	692,30
1000	300	BBN001561510160000.	970,90	1.121,90	1.525,50	BBN001561320160000.	543,00	618,50	820,30
1000	400	BBN001581510160000.	1.357,90	1.577,50	2.162,50	BBN001581320160000.	736,50	846,30	1.138,80

H1820 mm

Module mm	Shelf depth mm	Item no. Freestanding bay	Melamine EUR	Painted EUR	Veneer EUR	Item no. Intermediate bay	Melamine EUR	Painted EUR	Veneer EUR
500	250	BBN001645510160000.	983,60	1.130,00	1.520,20	BBN001645320160000.	492,20	565,40	760,50
500	300	BBN001665510160000.	1.167,60	1.346,60	1.822,20	BBN001665320160000.	584,20	673,70	911,50
500	400	BBN001685510160000.	1.627,20	1.887,00	2.580,00	BBN001685320160000.	814,00	943,90	1.290,40
750	250	BBN001647510160000.	983,60	1.130,00	1.520,20	BBN001647320160000.	492,20	565,40	760,50
750	300	BBN001667510160000.	1.167,60	1.346,60	1.822,20	BBN001667320160000.	584,20	673,70	911,50
750	400	BBN001687510160000.	1.627,20	1.887,00	2.580,00	BBN001687320160000.	814,00	943,90	1.290,40
900	250	BBN001649510160000.	983,60	1.130,00	1.520,20	BBN001649320160000.	492,20	565,40	760,50
900	300	BBN001669510160000.	1.167,60	1.346,60	1.822,20	BBN001669320160000.	584,20	673,70	911,50
900	400	BBN001689510160000.	1.627,20	1.887,00	2.580,00	BBN001689320160000.	814,00	943,90	1.290,40
1000	250	BBN001641510160000.	1.004,60	1.151,00	1.541,20	BBN001641320160000.	502,70	575,90	771,00
1000	300	BBN001661510160000.	1.188,60	1.367,60	1.843,20	BBN001661320160000.	594,70	684,20	922,00
1000	400	BBN001681510160000.	1.648,20	1.908,00	2.601,00	BBN001681320160000.	824,50	954,40	1.300,90

H2120 mm

Module mm	Shelf depth mm	Item no. Freestanding bay	Melamine EUR	Painted EUR	Veneer EUR	Item no. Intermediate bay	Melamine EUR	Painted EUR	Veneer EUR
500	250	BBN001745510160000.	1.091,00	1.255,60	1.696,00	BBN001745320160000.	545,90	628,20	848,40
500	300	BBN001765510160000.	1.317,60	1.522,80	2.069,20	BBN001765320160000.	659,20	761,80	1.035,00
500	400	BBN001785510160000.	1.846,40	2.143,80	2.939,20	BBN001785320160000.	923,60	1.072,30	1.470,00
750	250	BBN001747510160000.	1.091,00	1.255,60	1.696,00	BBN001747320160000.	545,90	628,20	848,40
750	300	BBN001767510160000.	1.317,60	1.522,80	2.069,20	BBN001767320160000.	659,20	761,80	1.035,00
750	400	BBN001787510160000.	1.846,40	2.143,80	2.939,20	BBN001787320160000.	923,60	1.072,30	1.470,00
900	250	BBN001749510160000.	1.091,00	1.255,60	1.696,00	BBN001749320160000.	545,90	628,20	848,40
900	300	BBN001769510160000.	1.317,60	1.522,80	2.069,20	BBN001769320160000.	659,20	761,80	1.035,00
900	400	BBN001789510160000.	1.846,40	2.143,80	2.939,20	BBN001789320160000.	923,60	1.072,30	1.470,00
1000	250	BBN001741510160000.	1.112,00	1.276,60	1.717,00	BBN001741320160000.	556,40	638,70	858,90
1000	300	BBN001761510160000.	1.338,60	1.543,80	2.090,20	BBN001761320160000.	669,70	772,30	1.045,50
1000	400	BBN001781510160000.	1.867,40	2.164,80	2.960,20	BBN001781320160000.	934,10	1.082,80	1.480,50

LINGO SHELVING SYSTEM

BBN001 - HIGH WOODEN BACK PANEL - ADJUSTABLE FEET - FOR TOP SHELF



LINGO SHELVING SYSTEM

BBN001 - HIGH WOODEN BACK PANEL - ADJUSTABLE FEET - FOR TOP SHELF

Shelving system with wooden panels, high wooden back panel and castor plate. To be used with ST1 standard depth, ST1 double-sided, ST2, ST3 and WT1 standard depth top shelf.

Freestanding bay includes 2 outer panels and 1 wooden back panel.

Intermediate bay includes 1 intermediate panel and 1 wooden back panel.

- Prices based on steel price group 1 and wooden price group A (see Design Options pages 6-9).

- For top shelves, see pages 156 & 174

- For shelves see page 144 & 166.

- For accessories see page 186.

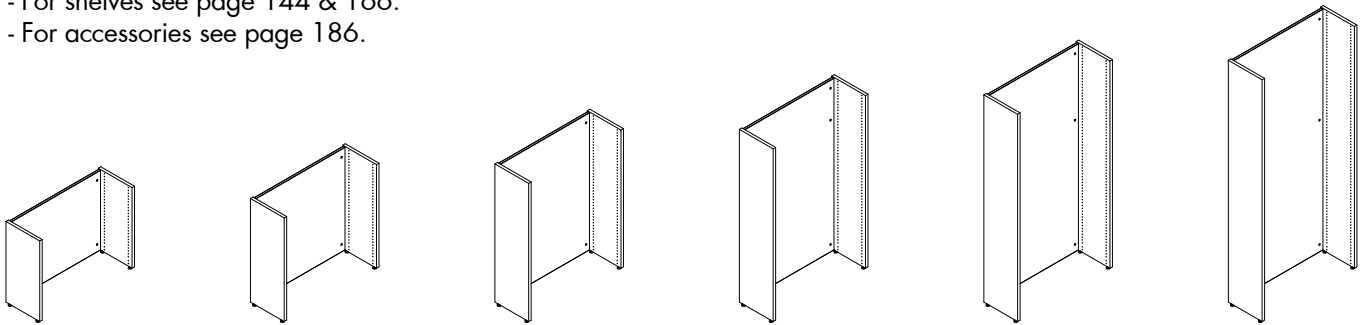

Single-sided freestanding bay - H720/920/1220/1520/1820/2120 mm

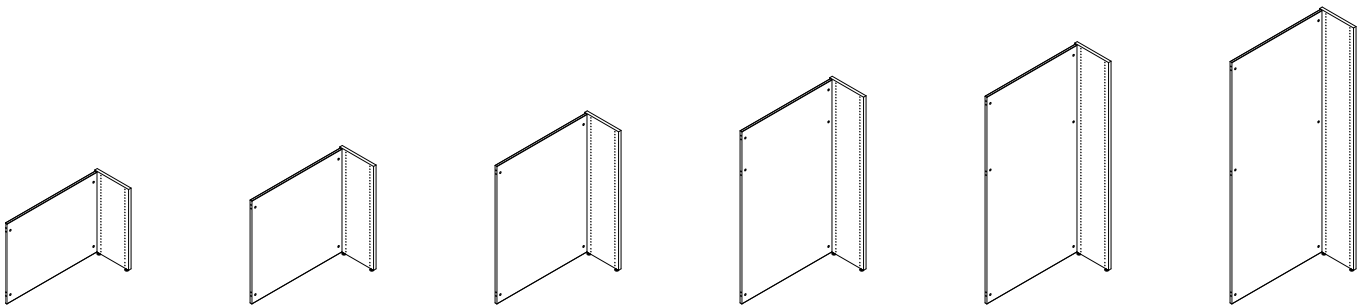

Single-sided intermediate bay - H720/920/1220/1520/1820/2120 mm

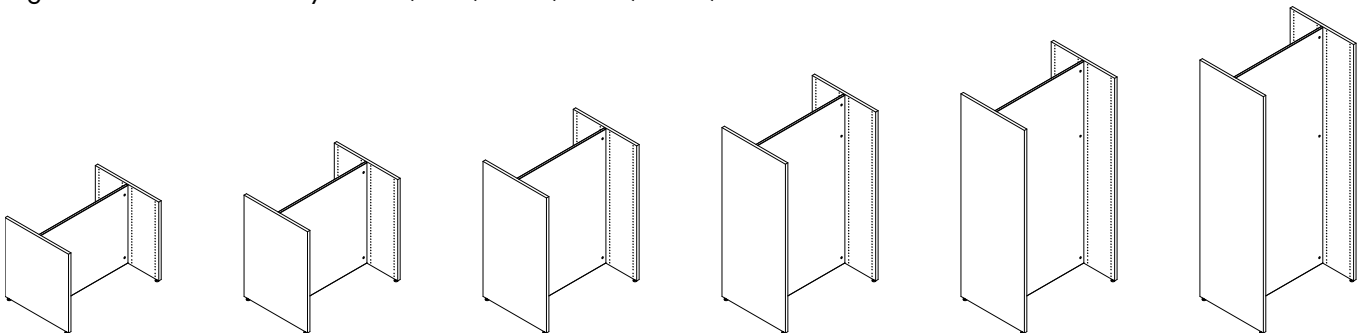

Double-sided freestanding bay - H720/920/1220/1520/1820/2120 mm

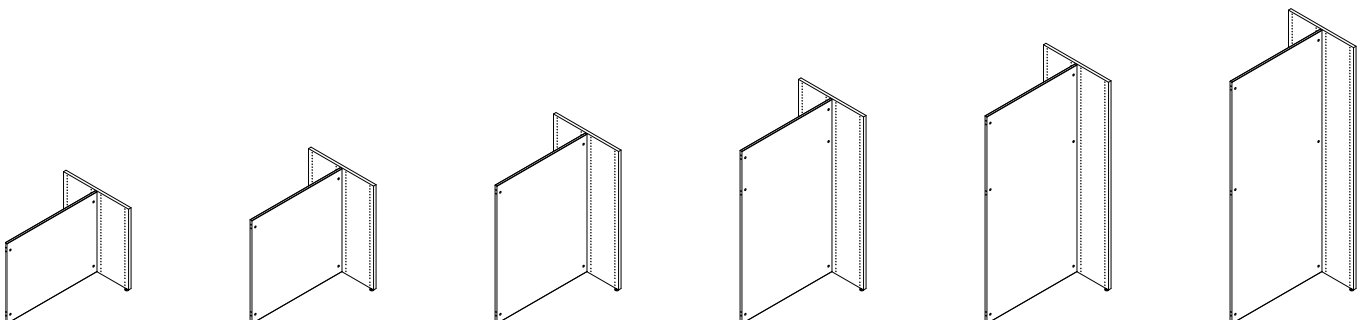

Double-sided intermediate bay - H720/920/1220/1520/1820/2120 mm

LINGO SHELVING SYSTEM

SINGLE-SIDED - HIGH WOODEN BACK PANEL - ADJUSTABLE FEET - FOR TOP SHELF

Painted and veneered Lingo Shelving Systems are FSC-certified.

H720 mm

Module mm	Shelf depth mm	Item no. Freestanding bay	Melamine EUR	Painted EUR	Veneer EUR	Item no. Intermediate bay	Melamine EUR	Painted EUR	Veneer EUR
500	250	BBN001235510120000.	361,70	425,80	596,90	BBN001235320120000.	234,30	275,70	386,50
500	300	BBN001255510120000.	398,90	468,80	657,50	BBN001255320120000.	252,90	297,20	416,80
500	400	BBN001275510120000.	502,70	591,40	828,30	BBN001275320120000.	304,80	358,50	502,20
750	250	BBN001237510120000.	415,00	488,80	685,40	BBN001237320120000.	287,60	338,70	475,00
750	300	BBN001257510120000.	452,20	531,80	746,00	BBN001257320120000.	306,20	360,20	505,30
750	400	BBN001277510120000.	556,00	654,40	916,80	BBN001277320120000.	358,10	421,50	590,70
900	250	BBN001239510120000.	455,10	535,70	750,80	BBN001239320120000.	327,70	385,60	540,40
900	300	BBN001259510120000.	492,30	578,70	811,40	BBN001259320120000.	346,30	407,10	570,70
900	400	BBN001279510120000.	596,10	701,30	982,20	BBN001279320120000.	398,20	468,40	656,10
1000	250	BBN001231510120000.	468,40	551,70	772,70	BBN001231320120000.	341,00	401,60	562,30
1000	300	BBN001251510120000.	505,60	594,70	833,30	BBN001251320120000.	359,60	423,10	592,60
1000	400	BBN001271510120000.	609,40	717,30	1.004,10	BBN001271320120000.	411,50	484,40	678,00

H920 mm

Module mm	Shelf depth mm	Item no. Freestanding bay	Melamine EUR	Painted EUR	Veneer EUR	Item no. Intermediate bay	Melamine EUR	Painted EUR	Veneer EUR
500	250	BBN001335510120000.	463,00	545,00	762,50	BBN001335320120000.	299,80	352,90	494,00
500	300	BBN001355510120000.	510,20	600,00	841,10	BBN001355320120000.	323,40	380,40	533,30
500	400	BBN001375510120000.	642,60	755,60	1.058,70	BBN001375320120000.	389,60	458,20	642,10
750	250	BBN001337510120000.	531,40	625,30	874,70	BBN001337320120000.	368,20	433,20	606,20
750	300	BBN001357510120000.	578,60	680,30	953,30	BBN001357320120000.	391,80	460,70	645,50
750	400	BBN001377510120000.	711,00	835,90	1.170,90	BBN001377320120000.	458,00	538,50	754,30
900	250	BBN001339510120000.	582,60	685,70	959,10	BBN001339320120000.	419,40	493,60	690,60
900	300	BBN001359510120000.	629,80	740,70	1.037,70	BBN001359320120000.	443,00	521,10	729,90
900	400	BBN001379510120000.	762,20	896,30	1.255,30	BBN001379320120000.	509,20	598,90	838,70
1000	250	BBN001331510120000.	599,60	705,60	986,40	BBN001331320120000.	436,40	513,50	717,90
1000	300	BBN001351510120000.	646,80	760,60	1.065,00	BBN001351320120000.	460,00	541,00	757,20
1000	400	BBN001371510120000.	779,20	916,20	1.282,60	BBN001371320120000.	526,20	618,80	866,00

H1220 mm

Module mm	Shelf depth mm	Item no. Freestanding bay	Melamine EUR	Painted EUR	Veneer EUR	Item no. Intermediate bay	Melamine EUR	Painted EUR	Veneer EUR
500	250	BBN001435510120000.	614,50	722,70	1.012,70	BBN001435320120000.	398,40	468,70	656,70
500	300	BBN001455510120000.	633,30	745,10	1.042,90	BBN001455320120000.	407,80	479,90	671,80
500	400	BBN001475510120000.	836,50	984,50	1.378,10	BBN001475320120000.	509,40	599,60	839,40
750	250	BBN001437510120000.	706,20	830,20	1.162,80	BBN001437320120000.	490,10	576,20	806,80
750	300	BBN001457510120000.	725,00	852,60	1.193,00	BBN001457320120000.	499,50	587,40	821,90
750	400	BBN001477510120000.	928,20	1.092,00	1.528,20	BBN001477320120000.	601,10	707,10	989,50
900	250	BBN001439510120000.	762,60	896,70	1.256,60	BBN001439320120000.	546,50	642,70	900,60
900	300	BBN001459510120000.	781,40	919,10	1.286,80	BBN001459320120000.	555,90	653,90	915,70
900	400	BBN001479510120000.	984,60	1.158,50	1.622,00	BBN001479320120000.	657,50	773,60	1.083,30
1000	250	BBN001431510120000.	796,80	936,90	1.312,10	BBN001431320120000.	580,70	682,90	956,10
1000	300	BBN001451510120000.	815,60	959,30	1.342,30	BBN001451320120000.	590,10	694,10	971,20
1000	400	BBN001471510120000.	1.018,80	1.198,70	1.677,50	BBN001471320120000.	691,70	813,80	1.138,80

LINGO SHELVING SYSTEM

SINGLE-SIDED - HIGH WOODEN BACK PANEL - ADJUSTABLE FEET - FOR TOP SHELF

Painted and veneered Lingo Shelving Systems are FSC-certified.

H1520 mm

Module mm	Shelf depth mm	Item no. Freestanding bay	Melamine EUR	Painted EUR	Veneer EUR	Item no. Intermediate bay	Melamine EUR	Painted EUR	Veneer EUR
500	250	BBN001535510120000.	714,50	840,60	1.176,90	BBN001535320120000.	468,90	551,60	772,40
500	300	BBN001555510120000.	732,90	862,80	1.206,90	BBN001555320120000.	478,10	562,70	787,40
500	400	BBN001575510120000.	977,50	1.149,80	1.609,10	BBN001575320120000.	600,40	706,20	988,50
750	250	BBN001537510120000.	826,10	972,10	1.360,60	BBN001537320120000.	580,50	683,10	956,10
750	300	BBN001557510120000.	844,50	994,30	1.390,60	BBN001557320120000.	589,70	694,20	971,10
750	400	BBN001577510120000.	1.089,10	1.281,30	1.792,80	BBN001577320120000.	712,00	837,70	1.172,20
900	250	BBN001539510120000.	900,60	1.059,70	1.483,90	BBN001539320120000.	655,00	770,70	1.079,40
900	300	BBN001559510120000.	919,00	1.081,90	1.513,90	BBN001559320120000.	664,20	781,80	1.094,40
900	400	BBN001579510120000.	1.163,60	1.368,90	1.916,10	BBN001579320120000.	786,50	925,30	1.295,50
1000	250	BBN001531510120000.	938,30	1.104,20	1.544,90	BBN001531320120000.	692,70	815,20	1.140,40
1000	300	BBN001551510120000.	956,70	1.126,40	1.574,90	BBN001551320120000.	701,90	826,30	1.155,40
1000	400	BBN001571510120000.	1.201,30	1.413,40	1.977,10	BBN001571320120000.	824,20	969,80	1.356,50

H1820 mm

Module mm	Shelf depth mm	Item no. Freestanding bay	Melamine EUR	Painted EUR	Veneer EUR	Item no. Intermediate bay	Melamine EUR	Painted EUR	Veneer EUR
500	250	BBN001635510120000.	835,10	982,40	1.375,00	BBN001635320120000.	547,10	643,60	900,60
500	300	BBN001655510120000.	848,50	998,40	1.396,20	BBN001655320120000.	553,80	651,60	911,20
500	400	BBN001675510120000.	1.121,90	1.319,80	1.848,00	BBN001675320120000.	690,50	812,30	1.137,10
750	250	BBN001637510120000.	964,30	1.134,30	1.588,50	BBN001637320120000.	676,30	795,50	1.114,10
750	300	BBN001657510120000.	977,70	1.150,30	1.609,70	BBN001657320120000.	683,00	803,50	1.124,70
750	400	BBN001677510120000.	1.251,10	1.471,70	2.061,50	BBN001677320120000.	819,70	964,20	1.350,60
900	250	BBN001639510120000.	1.058,40	1.245,40	1.743,10	BBN001639320120000.	770,40	906,60	1.268,70
900	300	BBN001659510120000.	1.071,80	1.261,40	1.764,30	BBN001659320120000.	777,10	914,60	1.279,30
900	400	BBN001679510120000.	1.345,20	1.582,80	2.216,10	BBN001679320120000.	913,80	1.075,30	1.505,20
1000	250	BBN001631510120000.	1.093,60	1.286,50	1.801,30	BBN001631320120000.	805,60	947,70	1.326,90
1000	300	BBN001651510120000.	1.107,00	1.302,50	1.822,50	BBN001651320120000.	812,30	955,70	1.337,50
1000	400	BBN001671510120000.	1.380,40	1.623,90	2.274,30	BBN001671320120000.	949,00	1.116,40	1.563,40

H2120 mm

Module mm	Shelf depth mm	Item no. Freestanding bay	Melamine EUR	Painted EUR	Veneer EUR	Item no. Intermediate bay	Melamine EUR	Painted EUR	Veneer EUR
500	250	BBN001735510120000.	941,40	1.107,30	1.550,60	BBN001735320120000.	620,40	729,60	1.021,80
500	300	BBN001755510120000.	953,60	1.121,70	1.570,40	BBN001755320120000.	626,50	736,80	1.031,70
500	400	BBN001775510120000.	1.246,00	1.465,70	2.051,60	BBN001775320120000.	772,70	908,80	1.272,30
750	250	BBN001737510120000.	1.090,60	1.283,40	1.796,20	BBN001737320120000.	769,60	905,70	1.267,40
750	300	BBN001757510120000.	1.102,80	1.297,80	1.816,00	BBN001757320120000.	775,70	912,90	1.277,30
750	400	BBN001777510120000.	1.395,20	1.641,80	2.297,20	BBN001777320120000.	921,90	1.084,90	1.517,90
900	250	BBN001739510120000.	1.198,70	1.410,40	1.975,00	BBN001739320120000.	877,70	1.032,70	1.446,20
900	300	BBN001759510120000.	1.210,90	1.424,80	1.994,80	BBN001759320120000.	883,80	1.039,90	1.456,10
900	400	BBN001779510120000.	1.503,30	1.768,80	2.476,00	BBN001779320120000.	1.030,00	1.211,90	1.696,70
1000	250	BBN001731510120000.	1.239,90	1.459,00	2.042,60	BBN001731320120000.	918,90	1.081,30	1.513,80
1000	300	BBN001751510120000.	1.252,10	1.473,40	2.062,40	BBN001751320120000.	925,00	1.088,50	1.523,70
1000	400	BBN001771510120000.	1.544,50	1.817,40	2.543,60	BBN001771320120000.	1.071,20	1.260,50	1.764,30

LINGO SHELVING SYSTEM

DOUBLE-SIDED - HIGH WOODEN BACK PANEL - ADJUSTABLE FEET - FOR TOP SHELF

Painted and veneered Lingo Shelving Systems are FSC-certified.

H720 mm

Module mm	Shelf depth mm	Item no. Freestanding bay	Melamine EUR	Painted EUR	Veneer EUR	Item no. Intermediate bay	Melamine EUR	Painted EUR	Veneer EUR
500	250	BBN001245510120000.	479,70	564,00	789,70	BBN001245320120000.	293,30	344,80	482,90
500	300	BBN001265510120000.	596,10	700,80	1.018,70	BBN001265320120000.	351,50	413,20	579,00
500	400	BBN001285510120000.	817,70	961,60	1.346,90	BBN001285320120000.	462,30	543,60	761,50
750	250	BBN001247510120000.	533,00	627,00	878,20	BBN001247320120000.	346,60	407,80	571,40
750	300	BBN001267510120000.	649,40	763,80	1.107,20	BBN001267320120000.	404,80	476,20	667,50
750	400	BBN001287510120000.	871,00	1.024,60	1.435,40	BBN001287320120000.	515,60	606,60	850,00
900	250	BBN001249510120000.	573,10	673,90	943,60	BBN001249320120000.	386,70	454,70	636,80
900	300	BBN001269510120000.	689,50	810,70	1.172,60	BBN001269320120000.	444,90	523,10	732,90
900	400	BBN001289510120000.	911,10	1.071,50	1.500,80	BBN001289320120000.	555,70	653,50	915,40
1000	250	BBN001241510120000.	586,40	689,90	965,50	BBN001241320120000.	400,00	470,70	658,70
1000	300	BBN001261510120000.	702,80	826,70	1.194,50	BBN001261320120000.	458,20	539,10	754,80
1000	400	BBN001281510120000.	924,40	1.087,50	1.522,70	BBN001281320120000.	569,00	669,50	937,30

H920 mm

Module mm	Shelf depth mm	Item no. Freestanding bay	Melamine EUR	Painted EUR	Veneer EUR	Item no. Intermediate bay	Melamine EUR	Painted EUR	Veneer EUR
500	250	BBN001345510120000.	612,60	720,80	1.009,50	BBN001345320120000.	374,60	440,80	617,50
500	300	BBN001365510120000.	761,80	896,60	1.255,70	BBN001365320120000.	449,20	528,70	740,60
500	400	BBN001385510120000.	1.044,80	1.228,80	1.720,70	BBN001385320120000.	590,70	694,80	973,10
750	250	BBN001347510120000.	681,00	801,10	1.121,70	BBN001347320120000.	443,00	521,10	729,70
750	300	BBN001367510120000.	830,20	976,90	1.367,90	BBN001367320120000.	517,60	609,00	852,80
750	400	BBN001387510120000.	1.113,20	1.309,10	1.832,90	BBN001387320120000.	659,10	775,10	1.085,30
900	250	BBN001349510120000.	732,20	861,50	1.206,10	BBN001349320120000.	494,20	581,50	814,10
900	300	BBN001369510120000.	881,40	1.037,30	1.452,30	BBN001369320120000.	568,80	669,40	937,20
900	400	BBN001389510120000.	1.164,40	1.369,50	1.917,30	BBN001389320120000.	710,30	835,50	1.169,70
1000	250	BBN001341510120000.	749,20	881,40	1.233,40	BBN001341320120000.	511,20	601,40	841,40
1000	300	BBN001361510120000.	898,40	1.057,20	1.479,60	BBN001361320120000.	585,80	689,30	964,50
1000	400	BBN001381510120000.	1.181,40	1.389,40	1.944,60	BBN001381320120000.	727,30	855,40	1.197,00

H1220 mm

Module mm	Shelf depth mm	Item no. Freestanding bay	Melamine EUR	Painted EUR	Veneer EUR	Item no. Intermediate bay	Melamine EUR	Painted EUR	Veneer EUR
500	250	BBN001445510120000.	810,30	953,70	1.335,90	BBN001445320120000.	496,30	584,20	818,30
500	300	BBN001465510120000.	994,70	1.170,30	1.639,50	BBN001465320120000.	588,50	692,50	970,10
500	400	BBN001485510120000.	1.362,90	1.603,70	2.246,10	BBN001485320120000.	772,60	909,20	1.273,40
750	250	BBN001447510120000.	902,00	1.061,20	1.486,00	BBN001447320120000.	588,00	691,70	968,40
750	300	BBN001467510120000.	1.086,40	1.277,80	1.789,60	BBN001467320120000.	680,20	800,00	1.120,20
750	400	BBN001487510120000.	1.454,60	1.711,20	2.396,20	BBN001487320120000.	864,30	1.016,70	1.423,50
900	250	BBN001449510120000.	958,40	1.127,70	1.579,80	BBN001449320120000.	644,40	758,20	1.062,20
900	300	BBN001469510120000.	1.142,80	1.344,30	1.883,40	BBN001469320120000.	736,60	866,50	1.214,00
900	400	BBN001489510120000.	1.511,00	1.777,70	2.490,00	BBN001489320120000.	920,70	1.083,20	1.517,30
1000	250	BBN001441510120000.	992,60	1.167,90	1.635,30	BBN001441320120000.	678,60	798,40	1.117,70
1000	300	BBN001461510120000.	1.177,00	1.384,50	1.938,90	BBN001461320120000.	770,80	906,70	1.269,50
1000	400	BBN001481510120000.	1.545,20	1.817,90	2.545,50	BBN001481320120000.	954,90	1.123,40	1.572,80

LINGO SHELVING SYSTEM

DOUBLE-SIDED - HIGH WOODEN BACK PANEL - ADJUSTABLE FEET - FOR TOP SHELF

Painted and veneered Lingo Shelving Systems are FSC-certified.

H1520 mm

Module mm	Shelf depth mm	Item no. Freestanding bay	Melamine EUR	Painted EUR	Veneer EUR	Item no. Intermediate bay	Melamine EUR	Painted EUR	Veneer EUR
500	250	BBN001545510120000.	924,70	1.087,60	1.522,30	BBN001545320120000.	574,00	675,10	945,10
500	300	BBN001565510120000.	1.079,10	1.269,40	1.778,30	BBN001565320120000.	651,20	766,00	1.073,10
500	400	BBN001585510120000.	1.466,10	1.725,00	2.415,30	BBN001585320120000.	844,70	993,80	1.391,60
750	250	BBN001547510120000.	1.036,30	1.219,10	1.706,00	BBN001547320120000.	685,60	806,60	1.128,80
750	300	BBN001567510120000.	1.190,70	1.400,90	1.962,00	BBN001567320120000.	762,80	897,50	1.256,80
750	400	BBN001587510120000.	1.577,70	1.856,50	2.599,00	BBN001587320120000.	956,30	1.125,30	1.575,30
900	250	BBN001549510120000.	1.110,80	1.306,70	1.829,30	BBN001549320120000.	760,10	894,20	1.252,10
900	300	BBN001569510120000.	1.265,20	1.488,50	2.085,30	BBN001569320120000.	837,30	985,10	1.380,10
900	400	BBN001589510120000.	1.652,20	1.944,10	2.722,30	BBN001589320120000.	1.030,80	1.212,90	1.698,60
1000	250	BBN001541510120000.	1.148,50	1.351,20	1.890,30	BBN001541320120000.	797,80	938,70	1.313,10
1000	300	BBN001561510120000.	1.302,90	1.533,00	2.146,30	BBN001561320120000.	875,00	1.029,60	1.441,10
1000	400	BBN001581510120000.	1.689,90	1.988,60	2.783,30	BBN001581320120000.	1.068,50	1.257,40	1.759,60

H1820 mm

Module mm	Shelf depth mm	Item no. Freestanding bay	Melamine EUR	Painted EUR	Veneer EUR	Item no. Intermediate bay	Melamine EUR	Painted EUR	Veneer EUR
500	250	BBN001645510120000.	1.086,10	1.278,20	1.789,80	BBN001645320120000.	672,60	791,50	1.108,00
500	300	BBN001665510120000.	1.270,10	1.494,80	2.091,80	BBN001665320120000.	764,60	899,80	1.259,00
500	400	BBN001685510120000.	1.729,70	2.035,20	2.849,60	BBN001685320120000.	994,40	1.170,00	1.637,90
750	250	BBN001647510120000.	1.215,30	1.430,10	2.003,30	BBN001647320120000.	801,80	943,40	1.321,50
750	300	BBN001667510120000.	1.399,30	1.646,70	2.305,30	BBN001667320120000.	893,80	1.051,70	1.472,50
750	400	BBN001687510120000.	1.858,90	2.187,10	3.063,10	BBN001687320120000.	1.123,60	1.321,90	1.851,40
900	250	BBN001649510120000.	1.309,40	1.541,20	2.157,90	BBN001649320120000.	895,90	1.054,50	1.476,10
900	300	BBN001669510120000.	1.493,40	1.757,80	2.459,90	BBN001669320120000.	987,90	1.162,80	1.627,10
900	400	BBN001689510120000.	1.953,00	2.298,20	3.217,70	BBN001689320120000.	1.217,70	1.433,00	2.006,00
1000	250	BBN001641510120000.	1.344,60	1.582,30	2.216,10	BBN001641320120000.	931,10	1.095,60	1.534,30
1000	300	BBN001661510120000.	1.528,60	1.798,90	2.518,10	BBN001661320120000.	1.023,10	1.203,90	1.685,30
1000	400	BBN001681510120000.	1.988,20	2.339,30	3.275,90	BBN001681320120000.	1.252,90	1.474,10	2.064,20

H2120 mm

Module mm	Shelf depth mm	Item no. Freestanding bay	Melamine EUR	Painted EUR	Veneer EUR	Item no. Intermediate bay	Melamine EUR	Painted EUR	Veneer EUR
500	250	BBN001745510120000.	1.233,80	1.450,90	2.032,40	BBN001745320120000.	766,60	901,40	1.262,70
500	300	BBN001765510120000.	1.460,40	1.718,10	2.405,60	BBN001765320120000.	879,90	1.035,00	1.449,30
500	400	BBN001785510120000.	1.989,20	2.339,10	3.275,60	BBN001785320120000.	1.144,30	1.345,50	1.884,30
750	250	BBN001747510120000.	1.383,00	1.627,00	2.278,00	BBN001747320120000.	915,80	1.077,50	1.508,30
750	300	BBN001767510120000.	1.609,60	1.894,20	2.651,20	BBN001767320120000.	1.029,10	1.211,10	1.694,90
750	400	BBN001787510120000.	2.138,40	2.515,20	3.521,20	BBN001787320120000.	1.293,50	1.521,60	2.129,90
900	250	BBN001749510120000.	1.491,10	1.754,00	2.456,80	BBN001749320120000.	1.023,90	1.204,50	1.687,10
900	300	BBN001769510120000.	1.717,70	2.021,20	2.830,00	BBN001769320120000.	1.137,20	1.338,10	1.873,70
900	400	BBN001789510120000.	2.246,50	2.642,20	3.700,00	BBN001789320120000.	1.401,60	1.648,60	2.308,70
1000	250	BBN001741510120000.	1.532,30	1.802,60	2.524,40	BBN001741320120000.	1.065,10	1.253,10	1.754,70
1000	300	BBN001761510120000.	1.758,90	2.069,80	2.897,60	BBN001761320120000.	1.178,40	1.386,70	1.941,30
1000	400	BBN001781510120000.	2.287,70	2.690,80	3.767,60	BBN001781320120000.	1.442,80	1.697,20	2.376,30

LINGO SHELVING SYSTEM

BBN001 - LOW WOODEN BACK PANEL - ADJUSTABLE FEET - FOR TOP SHELF



LINGO SHELVING SYSTEM

BBN001 - LOW WOODEN BACK PANEL - ADJUSTABLE FEET - FOR TOP SHELF

Shelving system with wooden panels and low wooden back panel.
To be used with ST1 full depth, WT1 full depth and WT1 double-sided top shelf.
Freestanding bay includes 2 outer panels and 1 wooden back panel.
Intermediate bay includes 1 intermediate panel and 1 wooden back panel.

- Prices based on steel price group 1 and wooden price group A (see Design Options pages 6-9).
- For top shelves, see pages 156 & 174
- For shelves see page 144 & 166.
- For accessories see page 186.

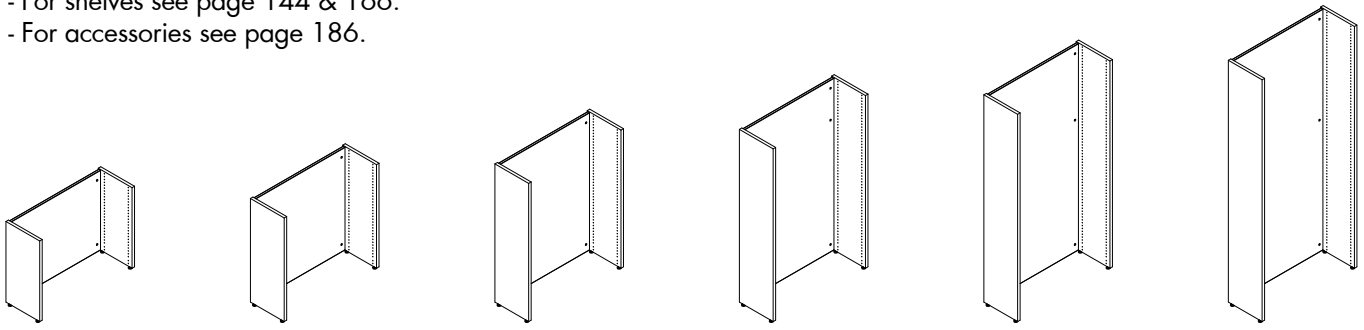

Single-sided freestanding bay - H720/920/1220/1520/1820/2120 mm

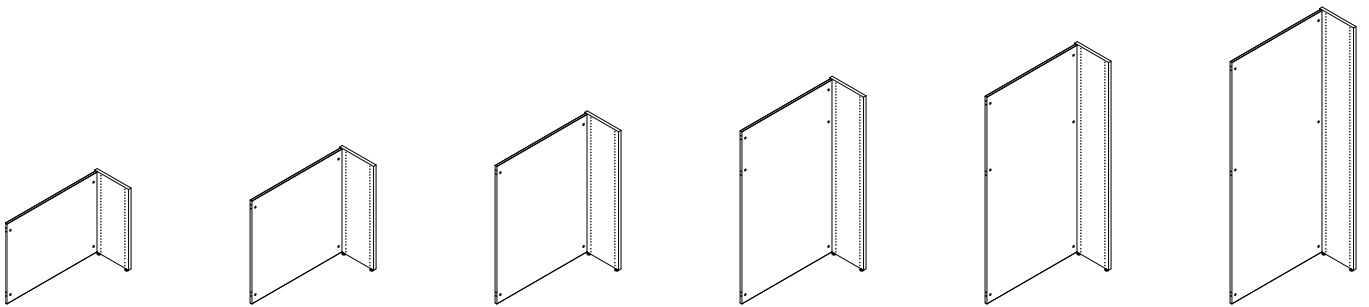

Single-sided intermediate bay - H720/920/1220/1520/1820/2120 mm

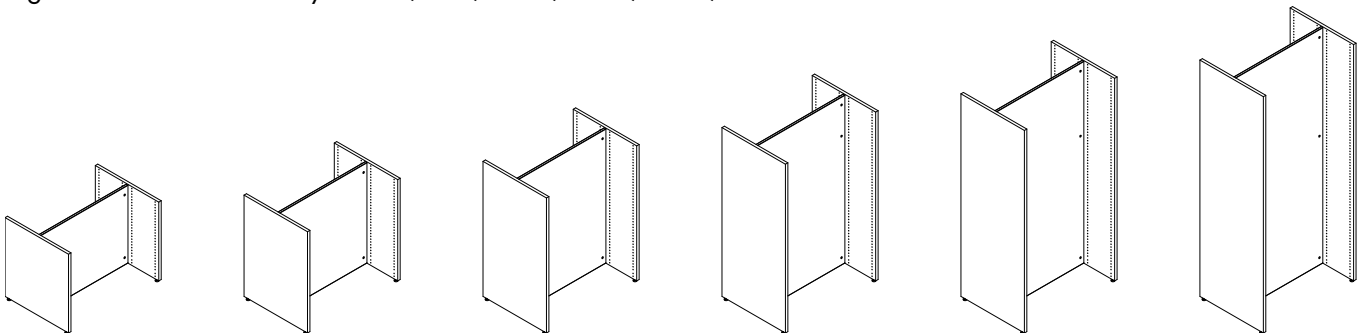

Double-sided freestanding bay - H720/920/1220/1520/1820/2120 mm

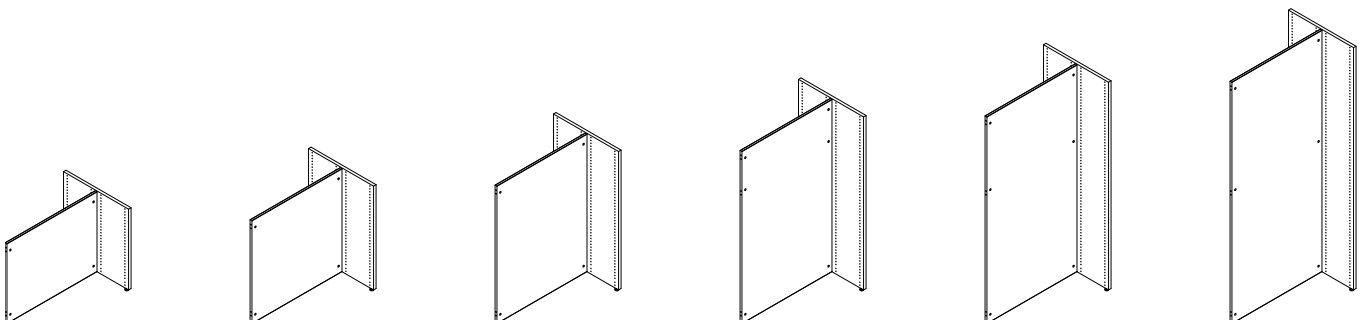

Double-sided intermediate bay - H720/920/1220/1520/1820/2120 mm

LINGO SHELVING SYSTEM

SINGLE-SIDED - LOW WOODEN BACK PANEL - ADJUSTABLE FEET - FOR TOP SHELF

Painted and veneered Lingo Shelving Systems are FSC-certified.

H720 mm

Module mm	Shelf depth mm	Item no. Freestanding bay	Melamine EUR	Painted EUR	Veneer EUR	Item no. Intermediate bay	Melamine EUR	Painted EUR	Veneer EUR
500	250	BBN001235510110000.	361,70	425,80	596,90	BBN001235320110000.	234,30	275,70	386,50
500	300	BBN001255510110000.	398,90	468,80	657,50	BBN001255320110000.	252,90	297,20	416,80
500	400	BBN001275510110000.	502,70	591,40	828,30	BBN001275320110000.	304,80	358,50	502,20
750	250	BBN001237510110000.	415,00	488,80	685,40	BBN001237320110000.	287,60	338,70	475,00
750	300	BBN001257510110000.	452,20	531,80	746,00	BBN001257320110000.	306,20	360,20	505,30
750	400	BBN001277510110000.	556,00	654,40	916,80	BBN001277320110000.	358,10	421,50	590,70
900	250	BBN001239510110000.	455,10	535,70	750,80	BBN001239320110000.	327,70	385,60	540,40
900	300	BBN001259510110000.	492,30	578,70	811,40	BBN001259320110000.	346,30	407,10	570,70
900	400	BBN001279510110000.	596,10	701,30	982,20	BBN001279320110000.	398,20	468,40	656,10
1000	250	BBN001231510110000.	468,40	551,70	772,70	BBN001231320110000.	341,00	401,60	562,30
1000	300	BBN001251510110000.	505,60	594,70	833,30	BBN001251320110000.	359,60	423,10	592,60
1000	400	BBN001271510110000.	609,40	717,30	1.004,10	BBN001271320110000.	411,50	484,40	678,00

H920 mm

Module mm	Shelf depth mm	Item no. Freestanding bay	Melamine EUR	Painted EUR	Veneer EUR	Item no. Intermediate bay	Melamine EUR	Painted EUR	Veneer EUR
500	250	BBN001335510110000.	463,00	545,00	762,50	BBN001335320110000.	299,80	352,90	494,00
500	300	BBN001355510110000.	510,20	600,00	841,10	BBN001355320110000.	323,40	380,40	533,30
500	400	BBN001375510110000.	642,60	755,60	1.058,70	BBN001375320110000.	389,60	458,20	642,10
750	250	BBN001337510110000.	531,40	625,30	874,70	BBN001337320110000.	368,20	433,20	606,20
750	300	BBN001357510110000.	578,60	680,30	953,30	BBN001357320110000.	391,80	460,70	645,50
750	400	BBN001377510110000.	711,00	835,90	1.170,90	BBN001377320110000.	458,00	538,50	754,30
900	250	BBN001339510110000.	582,60	685,70	959,10	BBN001339320110000.	419,40	493,60	690,60
900	300	BBN001359510110000.	629,80	740,70	1.037,70	BBN001359320110000.	443,00	521,10	729,90
900	400	BBN001379510110000.	762,20	896,30	1.255,30	BBN001379320110000.	509,20	598,90	838,70
1000	250	BBN001331510110000.	599,60	705,60	986,40	BBN001331320110000.	436,40	513,50	717,90
1000	300	BBN001351510110000.	646,80	760,60	1.065,00	BBN001351320110000.	460,00	541,00	757,20
1000	400	BBN001371510110000.	779,20	916,20	1.282,60	BBN001371320110000.	526,20	618,80	866,00

H1220 mm

Module mm	Shelf depth mm	Item no. Freestanding bay	Melamine EUR	Painted EUR	Veneer EUR	Item no. Intermediate bay	Melamine EUR	Painted EUR	Veneer EUR
500	250	BBN001435510110000.	614,50	722,70	1.012,70	BBN001435320110000.	398,40	468,70	656,70
500	300	BBN001455510110000.	633,30	745,10	1.042,90	BBN001455320110000.	407,80	479,90	671,80
500	400	BBN001475510110000.	836,50	984,50	1.378,10	BBN001475320110000.	509,40	599,60	839,40
750	250	BBN001437510110000.	706,20	830,20	1.162,80	BBN001437320110000.	490,10	576,20	806,80
750	300	BBN001457510110000.	725,00	852,60	1.193,00	BBN001457320110000.	499,50	587,40	821,90
750	400	BBN001477510110000.	928,20	1.092,00	1.528,20	BBN001477320110000.	601,10	707,10	989,50
900	250	BBN001439510110000.	762,60	896,70	1.256,60	BBN001439320110000.	546,50	642,70	900,60
900	300	BBN001459510110000.	781,40	919,10	1.286,80	BBN001459320110000.	555,90	653,90	915,70
900	400	BBN001479510110000.	984,60	1.158,50	1.622,00	BBN001479320110000.	657,50	773,60	1.083,30
1000	250	BBN001431510110000.	796,80	936,90	1.312,10	BBN001431320110000.	580,70	682,90	956,10
1000	300	BBN001451510110000.	815,60	959,30	1.342,30	BBN001451320110000.	590,10	694,10	971,20
1000	400	BBN001471510110000.	1.018,80	1.198,70	1.677,50	BBN001471320110000.	691,70	813,80	1.138,80

LINGO SHELVING SYSTEM

SINGLE-SIDED - LOW WOODEN BACK PANEL - ADJUSTABLE FEET - FOR TOP SHELF

Painted and veneered Lingo Shelving Systems are FSC-certified.

H1520 mm

Module mm	Shelf depth mm	Item no. Freestanding bay	Melamine EUR	Painted EUR	Veneer EUR	Item no. Intermediate bay	Melamine EUR	Painted EUR	Veneer EUR
500	250	BBN001535510110000.	714,50	840,60	1.176,90	BBN001535320110000.	468,90	551,60	772,40
500	300	BBN001555510110000.	732,90	862,80	1.206,90	BBN001555320110000.	478,10	562,70	787,40
500	400	BBN001575510110000.	977,50	1.149,80	1.609,10	BBN001575320110000.	600,40	706,20	988,50
750	250	BBN001537510110000.	826,10	972,10	1.360,60	BBN001537320110000.	580,50	683,10	956,10
750	300	BBN001557510110000.	844,50	994,30	1.390,60	BBN001557320110000.	589,70	694,20	971,10
750	400	BBN001577510110000.	1.089,10	1.281,30	1.792,80	BBN001577320110000.	712,00	837,70	1.172,20
900	250	BBN001539510110000.	900,60	1.059,70	1.483,90	BBN001539320110000.	655,00	770,70	1.079,40
900	300	BBN001559510110000.	919,00	1.081,90	1.513,90	BBN001559320110000.	664,20	781,80	1.094,40
900	400	BBN001579510110000.	1.163,60	1.368,90	1.916,10	BBN001579320110000.	786,50	925,30	1.295,50
1000	250	BBN001531510110000.	938,30	1.104,20	1.544,90	BBN001531320110000.	692,70	815,20	1.140,40
1000	300	BBN001551510110000.	956,70	1.126,40	1.574,90	BBN001551320110000.	701,90	826,30	1.155,40
1000	400	BBN001571510110000.	1.201,30	1.413,40	1.977,10	BBN001571320110000.	824,20	969,80	1.356,50

H1820 mm

Module mm	Shelf depth mm	Item no. Freestanding bay	Melamine EUR	Painted EUR	Veneer EUR	Item no. Intermediate bay	Melamine EUR	Painted EUR	Veneer EUR
500	250	BBN001635510110000.	835,10	982,40	1.375,00	BBN001635320110000.	547,10	643,60	900,60
500	300	BBN001655510110000.	848,50	998,40	1.396,20	BBN001655320110000.	553,80	651,60	911,20
500	400	BBN001675510110000.	1.121,90	1.319,80	1.848,00	BBN001675320110000.	690,50	812,30	1.137,10
750	250	BBN001637510110000.	964,30	1.134,30	1.588,50	BBN001637320110000.	676,30	795,50	1.114,10
750	300	BBN001657510110000.	977,70	1.150,30	1.609,70	BBN001657320110000.	683,00	803,50	1.124,70
750	400	BBN001677510110000.	1.251,10	1.471,70	2.061,50	BBN001677320110000.	819,70	964,20	1.350,60
900	250	BBN001639510110000.	1.058,40	1.245,40	1.743,10	BBN001639320110000.	770,40	906,60	1.268,70
900	300	BBN001659510110000.	1.071,80	1.261,40	1.764,30	BBN001659320110000.	777,10	914,60	1.279,30
900	400	BBN001679510110000.	1.345,20	1.582,80	2.216,10	BBN001679320110000.	913,80	1.075,30	1.505,20
1000	250	BBN001631510110000.	1.093,60	1.286,50	1.801,30	BBN001631320110000.	805,60	947,70	1.326,90
1000	300	BBN001651510110000.	1.107,00	1.302,50	1.822,50	BBN001651320110000.	812,30	955,70	1.337,50
1000	400	BBN001671510110000.	1.380,40	1.623,90	2.274,30	BBN001671320110000.	949,00	1.116,40	1.563,40

H2120 mm

Module mm	Shelf depth mm	Item no. Freestanding bay	Melamine EUR	Painted EUR	Veneer EUR	Item no. Intermediate bay	Melamine EUR	Painted EUR	Veneer EUR
500	250	BBN001735510110000.	941,40	1.107,30	1.550,60	BBN001735320110000.	620,40	729,60	1.021,80
500	300	BBN001755510110000.	953,60	1.121,70	1.570,40	BBN001755320110000.	626,50	736,80	1.031,70
500	400	BBN001775510110000.	1.246,00	1.465,70	2.051,60	BBN001775320110000.	772,70	908,80	1.272,30
750	250	BBN001737510110000.	1.090,60	1.283,40	1.796,20	BBN001737320110000.	769,60	905,70	1.267,40
750	300	BBN001757510110000.	1.102,80	1.297,80	1.816,00	BBN001757320110000.	775,70	912,90	1.277,30
750	400	BBN001777510110000.	1.395,20	1.641,80	2.297,20	BBN001777320110000.	921,90	1.084,90	1.517,90
900	250	BBN001739510110000.	1.198,70	1.410,40	1.975,00	BBN001739320110000.	877,70	1.032,70	1.446,20
900	300	BBN001759510110000.	1.210,90	1.424,80	1.994,80	BBN001759320110000.	883,80	1.039,90	1.456,10
900	400	BBN001779510110000.	1.503,30	1.768,80	2.476,00	BBN001779320110000.	1.030,00	1.211,90	1.696,70
1000	250	BBN001731510110000.	1.239,90	1.459,00	2.042,60	BBN001731320110000.	918,90	1.081,30	1.513,80
1000	300	BBN001751510110000.	1.252,10	1.473,40	2.062,40	BBN001751320110000.	925,00	1.088,50	1.523,70
1000	400	BBN001771510110000.	1.544,50	1.817,40	2.543,60	BBN001771320110000.	1.071,20	1.260,50	1.764,30

LINGO SHELVING SYSTEM

DOUBLE-SIDED - LOW WOODEN BACK PANEL - ADJUSTABLE FEET - FOR TOP SHELF

Painted and veneered Lingo Shelving Systems are FSC-certified.

H720 mm

Module mm	Shelf depth mm	Item no. Freestanding bay	Melamine EUR	Painted EUR	Veneer EUR	Item no. Intermediate bay	Melamine EUR	Painted EUR	Veneer EUR
500	250	BBN001245510110000.	479,70	564,00	789,70	BBN001245320110000.	293,30	344,80	482,90
500	300	BBN001265510110000.	596,10	700,80	1.018,70	BBN001265320110000.	351,50	413,20	579,00
500	400	BBN001285510110000.	817,70	961,60	1.346,90	BBN001285320110000.	462,30	543,60	761,50
750	250	BBN001247510110000.	533,00	627,00	878,20	BBN001247320110000.	346,60	407,80	571,40
750	300	BBN001267510110000.	649,40	763,80	1.107,20	BBN001267320110000.	404,80	476,20	667,50
750	400	BBN001287510110000.	871,00	1.024,60	1.435,40	BBN001287320110000.	515,60	606,60	850,00
900	250	BBN001249510110000.	573,10	673,90	943,60	BBN001249320110000.	386,70	454,70	636,80
900	300	BBN001269510110000.	689,50	810,70	1.172,60	BBN001269320110000.	444,90	523,10	732,90
900	400	BBN001289510110000.	911,10	1.071,50	1.500,80	BBN001289320110000.	555,70	653,50	915,40
1000	250	BBN001241510110000.	586,40	689,90	965,50	BBN001241320110000.	400,00	470,70	658,70
1000	300	BBN001261510110000.	702,80	826,70	1.194,50	BBN001261320110000.	458,20	539,10	754,80
1000	400	BBN001281510110000.	924,40	1.087,50	1.522,70	BBN001281320110000.	569,00	669,50	937,30

H920 mm

Module mm	Shelf depth mm	Item no. Freestanding bay	Melamine EUR	Painted EUR	Veneer EUR	Item no. Intermediate bay	Melamine EUR	Painted EUR	Veneer EUR
500	250	BBN001345510110000.	612,60	720,80	1.009,50	BBN001345320110000.	374,60	440,80	617,50
500	300	BBN001365510110000.	761,80	896,60	1.255,70	BBN001365320110000.	449,20	528,70	740,60
500	400	BBN001385510110000.	1.044,80	1.228,80	1.720,70	BBN001385320110000.	590,70	694,80	973,10
750	250	BBN001347510110000.	681,00	801,10	1.121,70	BBN001347320110000.	443,00	521,10	729,70
750	300	BBN001367510110000.	830,20	976,90	1.367,90	BBN001367320110000.	517,60	609,00	852,80
750	400	BBN001387510110000.	1.113,20	1.309,10	1.832,90	BBN001387320110000.	659,10	775,10	1.085,30
900	250	BBN001349510110000.	732,20	861,50	1.206,10	BBN001349320110000.	494,20	581,50	814,10
900	300	BBN001369510110000.	881,40	1.037,30	1.452,30	BBN001369320110000.	568,80	669,40	937,20
900	400	BBN001389510110000.	1.164,40	1.369,50	1.917,30	BBN001389320110000.	710,30	835,50	1.169,70
1000	250	BBN001341510110000.	749,20	881,40	1.233,40	BBN001341320110000.	511,20	601,40	841,40
1000	300	BBN001361510110000.	898,40	1.057,20	1.479,60	BBN001361320110000.	585,80	689,30	964,50
1000	400	BBN001381510110000.	1.181,40	1.389,40	1.944,60	BBN001381320110000.	727,30	855,40	1.197,00

H1220 mm

Module mm	Shelf depth mm	Item no. Freestanding bay	Melamine EUR	Painted EUR	Veneer EUR	Item no. Intermediate bay	Melamine EUR	Painted EUR	Veneer EUR
500	250	BBN001445510110000.	810,30	953,70	1.335,90	BBN001445320110000.	496,30	584,20	818,30
500	300	BBN001465510110000.	994,70	1.170,30	1.639,50	BBN001465320110000.	588,50	692,50	970,10
500	400	BBN001485510110000.	1.362,90	1.603,70	2.246,10	BBN001485320110000.	772,60	909,20	1.273,40
750	250	BBN001447510110000.	902,00	1.061,20	1.486,00	BBN001447320110000.	588,00	691,70	968,40
750	300	BBN001467510110000.	1.086,40	1.277,80	1.789,60	BBN001467320110000.	680,20	800,00	1.120,20
750	400	BBN001487510110000.	1.454,60	1.711,20	2.396,20	BBN001487320110000.	864,30	1.016,70	1.423,50
900	250	BBN001449510110000.	958,40	1.127,70	1.579,80	BBN001449320110000.	644,40	758,20	1.062,20
900	300	BBN001469510110000.	1.142,80	1.344,30	1.883,40	BBN001469320110000.	736,60	866,50	1.214,00
900	400	BBN001489510110000.	1.511,00	1.777,70	2.490,00	BBN001489320110000.	920,70	1.083,20	1.517,30
1000	250	BBN001441510110000.	992,60	1.167,90	1.635,30	BBN001441320110000.	678,60	798,40	1.117,70
1000	300	BBN001461510110000.	1.177,00	1.384,50	1.938,90	BBN001461320110000.	770,80	906,70	1.269,50
1000	400	BBN001481510110000.	1.545,20	1.817,90	2.545,50	BBN001481320110000.	954,90	1.123,40	1.572,80

LINGO SHELVING SYSTEM

DOUBLE-SIDED - LOW WOODEN BACK PANEL - ADJUSTABLE FEET - FOR TOP SHELF

Painted and veneered Lingo Shelving Systems are FSC-certified.

H1520 mm

Module mm	Shelf depth mm	Item no. Freestanding bay	Melamine EUR	Painted EUR	Veneer EUR	Item no. Intermediate bay	Melamine EUR	Painted EUR	Veneer EUR
500	250	BBN001545510110000.	924,70	1.087,60	1.522,30	BBN001545320110000.	574,00	675,10	945,10
500	300	BBN001565510110000.	1.079,10	1.269,40	1.778,30	BBN001565320110000.	651,20	766,00	1.073,10
500	400	BBN001585510110000.	1.466,10	1.725,00	2.415,30	BBN001585320110000.	844,70	993,80	1.391,60
750	250	BBN001547510110000.	1.036,30	1.219,10	1.706,00	BBN001547320110000.	685,60	806,60	1.128,80
750	300	BBN001567510110000.	1.190,70	1.400,90	1.962,00	BBN001567320110000.	762,80	897,50	1.256,80
750	400	BBN001587510110000.	1.577,70	1.856,50	2.599,00	BBN001587320110000.	956,30	1.125,30	1.575,30
900	250	BBN001549510110000.	1.110,80	1.306,70	1.829,30	BBN001549320110000.	760,10	894,20	1.252,10
900	300	BBN001569510110000.	1.265,20	1.488,50	2.085,30	BBN001569320110000.	837,30	985,10	1.380,10
900	400	BBN001589510110000.	1.652,20	1.944,10	2.722,30	BBN001589320110000.	1.030,80	1.212,90	1.698,60
1000	250	BBN001541510110000.	1.148,50	1.351,20	1.890,30	BBN001541320110000.	797,80	938,70	1.313,10
1000	300	BBN001561510110000.	1.302,90	1.533,00	2.146,30	BBN001561320110000.	875,00	1.029,60	1.441,10
1000	400	BBN001581510110000.	1.689,90	1.988,60	2.783,30	BBN001581320110000.	1.068,50	1.257,40	1.759,60

H1820 mm

Module mm	Shelf depth mm	Item no. Freestanding bay	Melamine EUR	Painted EUR	Veneer EUR	Item no. Intermediate bay	Melamine EUR	Painted EUR	Veneer EUR
500	250	BBN001645510110000.	1.086,10	1.278,20	1.789,80	BBN001645320110000.	672,60	791,50	1.108,00
500	300	BBN001665510110000.	1.270,10	1.494,80	2.091,80	BBN001665320110000.	764,60	899,80	1.259,00
500	400	BBN001685510110000.	1.729,70	2.035,20	2.849,60	BBN001685320110000.	994,40	1.170,00	1.637,90
750	250	BBN001647510110000.	1.215,30	1.430,10	2.003,30	BBN001647320110000.	801,80	943,40	1.321,50
750	300	BBN001667510110000.	1.399,30	1.646,70	2.305,30	BBN001667320110000.	893,80	1.051,70	1.472,50
750	400	BBN001687510110000.	1.858,90	2.187,10	3.063,10	BBN001687320110000.	1.123,60	1.321,90	1.851,40
900	250	BBN001649510110000.	1.309,40	1.541,20	2.157,90	BBN001649320110000.	895,90	1.054,50	1.476,10
900	300	BBN001669510110000.	1.493,40	1.757,80	2.459,90	BBN001669320110000.	987,90	1.162,80	1.627,10
900	400	BBN001689510110000.	1.953,00	2.298,20	3.217,70	BBN001689320110000.	1.217,70	1.433,00	2.006,00
1000	250	BBN001641510110000.	1.344,60	1.582,30	2.216,10	BBN001641320110000.	931,10	1.095,60	1.534,30
1000	300	BBN001661510110000.	1.528,60	1.798,90	2.518,10	BBN001661320110000.	1.023,10	1.203,90	1.685,30
1000	400	BBN001681510110000.	1.988,20	2.339,30	3.275,90	BBN001681320110000.	1.252,90	1.474,10	2.064,20

H2120 mm

Module mm	Shelf depth mm	Item no. Freestanding bay	Melamine EUR	Painted EUR	Veneer EUR	Item no. Intermediate bay	Melamine EUR	Painted EUR	Veneer EUR
500	250	BBN001745510110000.	1.233,80	1.450,90	2.032,40	BBN001745320110000.	766,60	901,40	1.262,70
500	300	BBN001765510110000.	1.460,40	1.718,10	2.405,60	BBN001765320110000.	879,90	1.035,00	1.449,30
500	400	BBN001785510110000.	1.989,20	2.339,10	3.275,60	BBN001785320110000.	1.144,30	1.345,50	1.884,30
750	250	BBN001747510110000.	1.383,00	1.627,00	2.278,00	BBN001747320110000.	915,80	1.077,50	1.508,30
750	300	BBN001767510110000.	1.609,60	1.894,20	2.651,20	BBN001767320110000.	1.029,10	1.211,10	1.694,90
750	400	BBN001787510110000.	2.138,40	2.515,20	3.521,20	BBN001787320110000.	1.293,50	1.521,60	2.129,90
900	250	BBN001749510110000.	1.491,10	1.754,00	2.456,80	BBN001749320110000.	1.023,90	1.204,50	1.687,10
900	300	BBN001769510110000.	1.717,70	2.021,20	2.830,00	BBN001769320110000.	1.137,20	1.338,10	1.873,70
900	400	BBN001789510110000.	2.246,50	2.642,20	3.700,00	BBN001789320110000.	1.401,60	1.648,60	2.308,70
1000	250	BBN001741510110000.	1.532,30	1.802,60	2.524,40	BBN001741320110000.	1.065,10	1.253,10	1.754,70
1000	300	BBN001761510110000.	1.758,90	2.069,80	2.897,60	BBN001761320110000.	1.178,40	1.386,70	1.941,30
1000	400	BBN001781510110000.	2.287,70	2.690,80	3.767,60	BBN001781320110000.	1.442,80	1.697,20	2.376,30

LINGO SHELVING SYSTEM

BBN001 - CROSS BRACE - ADJUSTABLE FEET - FOR TOP SHELF



LINGO SHELVING SYSTEM

BBN001 - CROSS BRACE - ADJUSTABLE FEET - FOR TOP SHELF

Shelving system with wooden panels and cross brace. To be used with top shelf.

Freestanding bay includes 2 outer panels and 1 cross brace.

Intermediate bay includes 1 intermediate panel and 1 cross brace.

Middle shelf must be screwed into panels for bays above H1220 mm.

- Prices based on steel price group 1 and wooden price group A (see Design Options pages 6-9).

- For top shelves, see pages 156 & 174

- For shelves see page 144 & 166.

- For accessories see page 186.

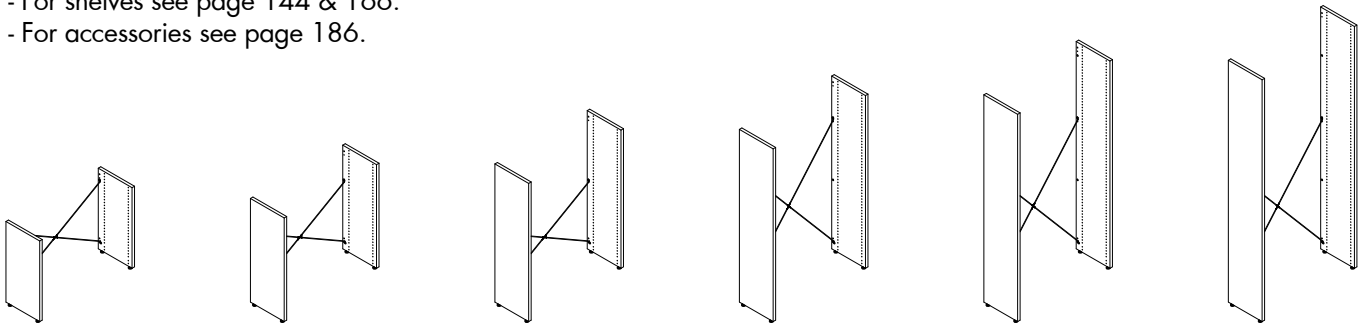

Single-sided freestanding bay - H720/920/1220/1520/1820/2120 mm

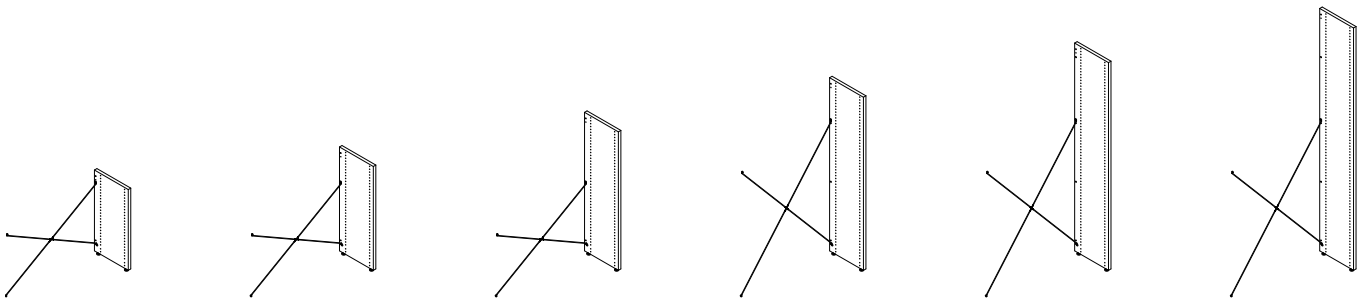

Single-sided intermediate bay - H720/920/1220/1520/1820/2120 mm

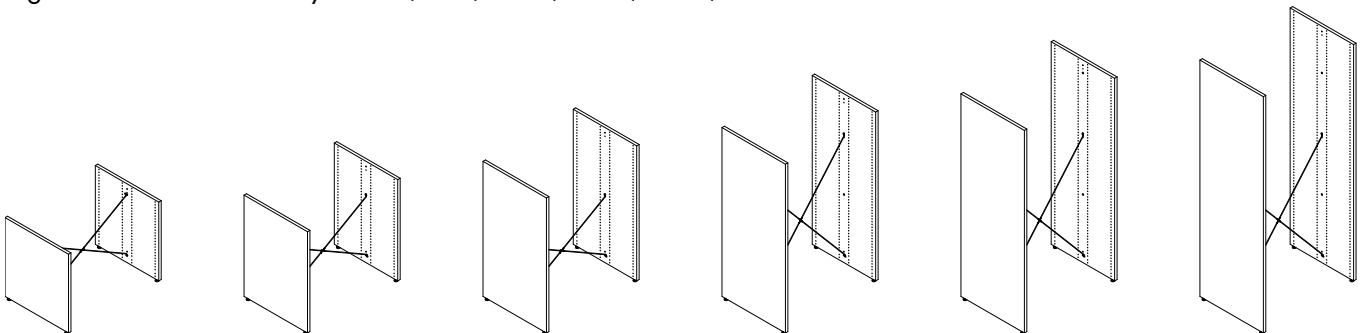

Double-sided freestanding bay - H720/920/1220/1520/1820/2120 mm

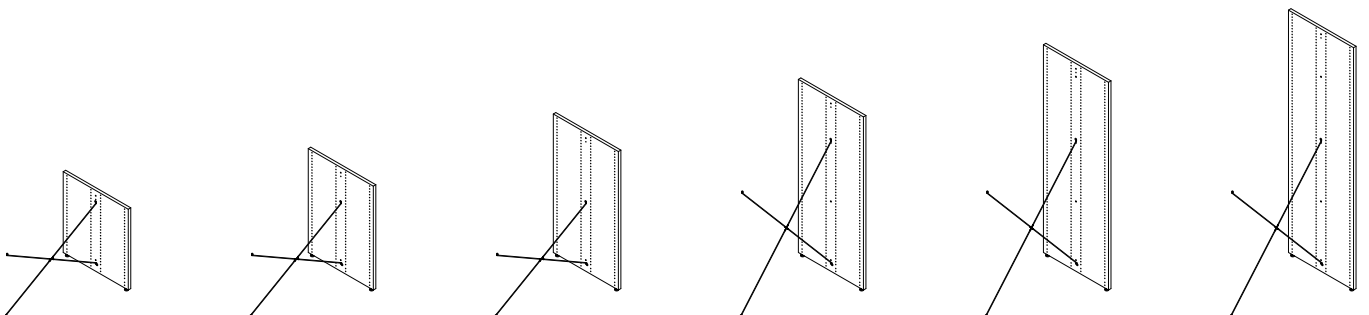

Double-sided intermediate bay - H720/920/1220/1520/1820/2120 mm

LINGO SHELVING SYSTEM

SINGLE-SIDED - CROSS BRACE - ADJUSTABLE FEET - FOR TOP SHELF

Painted and veneered Lingo Shelving Systems are FSC-certified.

H720 mm

Module mm	Shelf depth mm	Item no. Freestanding bay	Melamine EUR	Painted EUR	Veneer EUR	Item no. Intermediate bay	Melamine EUR	Painted EUR	Veneer EUR
500	250	BBN001235510190000.	276,60	322,00	442,60	BBN001235320190000.	149,20	171,90	232,20
500	300	BBN001255510190000.	313,80	365,00	503,20	BBN001255320190000.	167,80	193,40	262,50
500	400	BBN001275510190000.	417,60	487,60	674,00	BBN001275320190000.	219,70	254,70	347,90
750	250	BBN001237510190000.	276,60	322,00	442,60	BBN001237320190000.	149,20	171,90	232,20
750	300	BBN001257510190000.	313,80	365,00	503,20	BBN001257320190000.	167,80	193,40	262,50
750	400	BBN001277510190000.	417,60	487,60	674,00	BBN001277320190000.	219,70	254,70	347,90
900	250	BBN001239510190000.	276,60	322,00	442,60	BBN001239320190000.	149,20	171,90	232,20
900	300	BBN001259510190000.	313,80	365,00	503,20	BBN001259320190000.	167,80	193,40	262,50
900	400	BBN001279510190000.	417,60	487,60	674,00	BBN001279320190000.	219,70	254,70	347,90
1000	250	BBN001231510190000.	276,60	322,00	442,60	BBN001231320190000.	149,20	171,90	232,20
1000	300	BBN001251510190000.	313,80	365,00	503,20	BBN001251320190000.	167,80	193,40	262,50
1000	400	BBN001271510190000.	417,60	487,60	674,00	BBN001271320190000.	219,70	254,70	347,90

H920 mm

Module mm	Shelf depth mm	Item no. Freestanding bay	Melamine EUR	Painted EUR	Veneer EUR	Item no. Intermediate bay	Melamine EUR	Painted EUR	Veneer EUR
500	250	BBN001335510190000.	348,20	406,00	558,80	BBN001335320190000.	185,00	213,90	290,30
500	300	BBN001355510190000.	395,40	461,00	637,40	BBN001355320190000.	208,60	241,40	329,60
500	400	BBN001375510190000.	527,80	616,60	855,00	BBN001375320190000.	274,80	319,20	438,40
750	250	BBN001337510190000.	348,20	406,00	558,80	BBN001337320190000.	185,00	213,90	290,30
750	300	BBN001357510190000.	395,40	461,00	637,40	BBN001357320190000.	208,60	241,40	329,60
750	400	BBN001377510190000.	527,80	616,60	855,00	BBN001377320190000.	274,80	319,20	438,40
900	250	BBN001339510190000.	348,20	406,00	558,80	BBN001339320190000.	185,00	213,90	290,30
900	300	BBN001359510190000.	395,40	461,00	637,40	BBN001359320190000.	208,60	241,40	329,60
900	400	BBN001379510190000.	527,80	616,60	855,00	BBN001379320190000.	274,80	319,20	438,40
1000	250	BBN001331510190000.	348,20	406,00	558,80	BBN001331320190000.	185,00	213,90	290,30
1000	300	BBN001351510190000.	395,40	461,00	637,40	BBN001351320190000.	208,60	241,40	329,60
1000	400	BBN001371510190000.	527,80	616,60	855,00	BBN001371320190000.	274,80	319,20	438,40

H1220 mm

Module mm	Shelf depth mm	Item no. Freestanding bay	Melamine EUR	Painted EUR	Veneer EUR	Item no. Intermediate bay	Melamine EUR	Painted EUR	Veneer EUR
500	250	BBN001435510190000.	454,00	529,80	733,80	BBN001435320190000.	237,90	275,80	377,80
500	300	BBN001455510190000.	472,80	552,20	764,00	BBN001455320190000.	247,30	287,00	392,90
500	400	BBN001475510190000.	676,00	791,60	1.099,20	BBN001475320190000.	348,90	406,70	560,50
750	250	BBN001437510190000.	454,00	529,80	733,80	BBN001437320190000.	237,90	275,80	377,80
750	300	BBN001457510190000.	472,80	552,20	764,00	BBN001457320190000.	247,30	287,00	392,90
750	400	BBN001477510190000.	676,00	791,60	1.099,20	BBN001477320190000.	348,90	406,70	560,50
900	250	BBN001439510190000.	454,00	529,80	733,80	BBN001439320190000.	237,90	275,80	377,80
900	300	BBN001459510190000.	472,80	552,20	764,00	BBN001459320190000.	247,30	287,00	392,90
900	400	BBN001479510190000.	676,00	791,60	1.099,20	BBN001479320190000.	348,90	406,70	560,50
1000	250	BBN001431510190000.	454,00	529,80	733,80	BBN001431320190000.	237,90	275,80	377,80
1000	300	BBN001451510190000.	472,80	552,20	764,00	BBN001451320190000.	247,30	287,00	392,90
1000	400	BBN001471510190000.	676,00	791,60	1.099,20	BBN001471320190000.	348,90	406,70	560,50

LINGO SHELVING SYSTEM

SINGLE-SIDED - CROSS BRACE - ADJUSTABLE FEET - FOR TOP SHELF

Painted and veneered Lingo Shelving Systems are FSC-certified.

H1520 mm

Module mm	Shelf depth mm	Item no. Freestanding bay	Melamine EUR	Painted EUR	Veneer EUR	Item no. Intermediate bay	Melamine EUR	Painted EUR	Veneer EUR
500	250	BBN001535510190000.	513,00	599,80	830,80	BBN001535320190000.	267,40	310,80	426,30
500	300	BBN001555510190000.	531,40	622,00	860,80	BBN001555320190000.	276,60	321,90	441,30
500	400	BBN001575510190000.	776,00	909,00	1.263,00	BBN001575320190000.	398,90	465,40	642,40
750	250	BBN001537510190000.	513,00	599,80	830,80	BBN001537320190000.	267,40	310,80	426,30
750	300	BBN001557510190000.	531,40	622,00	860,80	BBN001557320190000.	276,60	321,90	441,30
750	400	BBN001577510190000.	776,00	909,00	1.263,00	BBN001577320190000.	398,90	465,40	642,40
900	250	BBN001539510190000.	513,00	599,80	830,80	BBN001539320190000.	267,40	310,80	426,30
900	300	BBN001559510190000.	531,40	622,00	860,80	BBN001559320190000.	276,60	321,90	441,30
900	400	BBN001579510190000.	776,00	909,00	1.263,00	BBN001579320190000.	398,90	465,40	642,40
1000	250	BBN001531510190000.	513,00	599,80	830,80	BBN001531320190000.	267,40	310,80	426,30
1000	300	BBN001551510190000.	531,40	622,00	860,80	BBN001551320190000.	276,60	321,90	441,30
1000	400	BBN001571510190000.	776,00	909,00	1.263,00	BBN001571320190000.	398,90	465,40	642,40

H1820 mm

Module mm	Shelf depth mm	Item no. Freestanding bay	Melamine EUR	Painted EUR	Veneer EUR	Item no. Intermediate bay	Melamine EUR	Painted EUR	Veneer EUR
500	250	BBN001635510190000.	597,80	699,40	970,60	BBN001635320190000.	309,80	360,60	496,20
500	300	BBN001655510190000.	611,20	715,40	991,80	BBN001655320190000.	316,50	368,60	506,80
500	400	BBN001675510190000.	884,60	1.036,80	1.443,60	BBN001675320190000.	453,20	529,30	732,70
750	250	BBN001637510190000.	597,80	699,40	970,60	BBN001637320190000.	309,80	360,60	496,20
750	300	BBN001657510190000.	611,20	715,40	991,80	BBN001657320190000.	316,50	368,60	506,80
750	400	BBN001677510190000.	884,60	1.036,80	1.443,60	BBN001677320190000.	453,20	529,30	732,70
900	250	BBN001639510190000.	597,80	699,40	970,60	BBN001639320190000.	309,80	360,60	496,20
900	300	BBN001659510190000.	611,20	715,40	991,80	BBN001659320190000.	316,50	368,60	506,80
900	400	BBN001679510190000.	884,60	1.036,80	1.443,60	BBN001679320190000.	453,20	529,30	732,70
1000	250	BBN001631510190000.	597,80	699,40	970,60	BBN001631320190000.	309,80	360,60	496,20
1000	300	BBN001651510190000.	611,20	715,40	991,80	BBN001651320190000.	316,50	368,60	506,80
1000	400	BBN001671510190000.	884,60	1.036,80	1.443,60	BBN001671320190000.	453,20	529,30	732,70

H2120 mm

Module mm	Shelf depth mm	Item no. Freestanding bay	Melamine EUR	Painted EUR	Veneer EUR	Item no. Intermediate bay	Melamine EUR	Painted EUR	Veneer EUR
500	250	BBN001735510190000.	663,80	777,20	1.079,40	BBN001735320190000.	342,80	399,50	550,60
500	300	BBN001755510190000.	676,00	791,60	1.099,20	BBN001755320190000.	348,90	406,70	560,50
500	400	BBN001775510190000.	968,40	1.135,60	1.580,40	BBN001775320190000.	495,10	578,70	801,10
750	250	BBN001737510190000.	663,80	777,20	1.079,40	BBN001737320190000.	342,80	399,50	550,60
750	300	BBN001757510190000.	676,00	791,60	1.099,20	BBN001757320190000.	348,90	406,70	560,50
750	400	BBN001777510190000.	968,40	1.135,60	1.580,40	BBN001777320190000.	495,10	578,70	801,10
900	250	BBN001739510190000.	663,80	777,20	1.079,40	BBN001739320190000.	342,80	399,50	550,60
900	300	BBN001759510190000.	676,00	791,60	1.099,20	BBN001759320190000.	348,90	406,70	560,50
900	400	BBN001779510190000.	968,40	1.135,60	1.580,40	BBN001779320190000.	495,10	578,70	801,10
1000	250	BBN001731510190000.	663,80	777,20	1.079,40	BBN001731320190000.	342,80	399,50	550,60
1000	300	BBN001751510190000.	676,00	791,60	1.099,20	BBN001751320190000.	348,90	406,70	560,50
1000	400	BBN001771510190000.	968,40	1.135,60	1.580,40	BBN001771320190000.	495,10	578,70	801,10

LINGO SHELVING SYSTEM

DOUBLE-SIDED - CROSS BRACE - ADJUSTABLE FEET - FOR TOP SHELF

Painted and veneered Lingo Shelving Systems are FSC-certified.

H720 mm

Module mm	Shelf depth mm	Item no. Freestanding bay	Melamine EUR	Painted EUR	Veneer EUR	Item no. Intermediate bay	Melamine EUR	Painted EUR	Veneer EUR
500	250	BBN001245510190000.	394,60	460,20	635,40	BBN001245320190000.	208,20	241,00	328,60
500	300	BBN001265510190000.	511,00	597,00	864,40	BBN001265320190000.	266,40	309,40	424,70
500	400	BBN001285510190000.	732,60	857,80	1.192,60	BBN001285320190000.	377,20	439,80	607,20
750	250	BBN001247510190000.	394,60	460,20	635,40	BBN001247320190000.	208,20	241,00	328,60
750	300	BBN001267510190000.	511,00	597,00	864,40	BBN001267320190000.	266,40	309,40	424,70
750	400	BBN001287510190000.	732,60	857,80	1.192,60	BBN001287320190000.	377,20	439,80	607,20
900	250	BBN001249510190000.	394,60	460,20	635,40	BBN001249320190000.	208,20	241,00	328,60
900	300	BBN001269510190000.	511,00	597,00	864,40	BBN001269320190000.	266,40	309,40	424,70
900	400	BBN001289510190000.	732,60	857,80	1.192,60	BBN001289320190000.	377,20	439,80	607,20
1000	250	BBN001241510190000.	394,60	460,20	635,40	BBN001241320190000.	208,20	241,00	328,60
1000	300	BBN001261510190000.	511,00	597,00	864,40	BBN001261320190000.	266,40	309,40	424,70
1000	400	BBN001281510190000.	732,60	857,80	1.192,60	BBN001281320190000.	377,20	439,80	607,20

H920 mm

Module mm	Shelf depth mm	Item no. Freestanding bay	Melamine EUR	Painted EUR	Veneer EUR	Item no. Intermediate bay	Melamine EUR	Painted EUR	Veneer EUR
500	250	BBN001345510190000.	497,80	581,80	805,80	BBN001345320190000.	259,80	301,80	413,80
500	300	BBN001365510190000.	647,00	757,60	1.052,00	BBN001365320190000.	334,40	389,70	536,90
500	400	BBN001385510190000.	930,00	1.089,80	1.517,00	BBN001385320190000.	475,90	555,80	769,40
750	250	BBN001347510190000.	497,80	581,80	805,80	BBN001347320190000.	259,80	301,80	413,80
750	300	BBN001367510190000.	647,00	757,60	1.052,00	BBN001367320190000.	334,40	389,70	536,90
750	400	BBN001387510190000.	930,00	1.089,80	1.517,00	BBN001387320190000.	475,90	555,80	769,40
900	250	BBN001349510190000.	497,80	581,80	805,80	BBN001349320190000.	259,80	301,80	413,80
900	300	BBN001369510190000.	647,00	757,60	1.052,00	BBN001369320190000.	334,40	389,70	536,90
900	400	BBN001389510190000.	930,00	1.089,80	1.517,00	BBN001389320190000.	475,90	555,80	769,40
1000	250	BBN001341510190000.	497,80	581,80	805,80	BBN001341320190000.	259,80	301,80	413,80
1000	300	BBN001361510190000.	647,00	757,60	1.052,00	BBN001361320190000.	334,40	389,70	536,90
1000	400	BBN001381510190000.	930,00	1.089,80	1.517,00	BBN001381320190000.	475,90	555,80	769,40

H1220 mm

Module mm	Shelf depth mm	Item no. Freestanding bay	Melamine EUR	Painted EUR	Veneer EUR	Item no. Intermediate bay	Melamine EUR	Painted EUR	Veneer EUR
500	250	BBN001445510190000.	649,80	760,80	1.057,00	BBN001445320190000.	335,80	391,30	539,40
500	300	BBN001465510190000.	834,20	977,40	1.360,60	BBN001465320190000.	428,00	499,60	691,20
500	400	BBN001485510190000.	1.202,40	1.410,80	1.967,20	BBN001485320190000.	612,10	716,30	994,50
750	250	BBN001447510190000.	649,80	760,80	1.057,00	BBN001447320190000.	335,80	391,30	539,40
750	300	BBN001467510190000.	834,20	977,40	1.360,60	BBN001467320190000.	428,00	499,60	691,20
750	400	BBN001487510190000.	1.202,40	1.410,80	1.967,20	BBN001487320190000.	612,10	716,30	994,50
900	250	BBN001449510190000.	649,80	760,80	1.057,00	BBN001449320190000.	335,80	391,30	539,40
900	300	BBN001469510190000.	834,20	977,40	1.360,60	BBN001469320190000.	428,00	499,60	691,20
900	400	BBN001489510190000.	1.202,40	1.410,80	1.967,20	BBN001489320190000.	612,10	716,30	994,50
1000	250	BBN001441510190000.	649,80	760,80	1.057,00	BBN001441320190000.	335,80	391,30	539,40
1000	300	BBN001461510190000.	834,20	977,40	1.360,60	BBN001461320190000.	428,00	499,60	691,20
1000	400	BBN001481510190000.	1.202,40	1.410,80	1.967,20	BBN001481320190000.	612,10	716,30	994,50

LINGO SHELVING SYSTEM

DOUBLE-SIDED - CROSS BRACE - ADJUSTABLE FEET - FOR TOP SHELF

Painted and veneered Lingo Shelving Systems are FSC-certified.

H1520 mm

Module mm	Shelf depth mm	Item no. Freestanding bay	Melamine EUR	Painted EUR	Veneer EUR	Item no. Intermediate bay	Melamine EUR	Painted EUR	Veneer EUR
500	250	BBN001545510190000.	723,20	846,80	1.176,20	BBN001545320190000.	372,50	434,30	599,00
500	300	BBN001565510190000.	877,60	1.028,60	1.432,20	BBN001565320190000.	449,70	525,20	727,00
500	400	BBN001585510190000.	1.264,60	1.484,20	2.069,20	BBN001585320190000.	643,20	753,00	1.045,50
750	250	BBN001547510190000.	723,20	846,80	1.176,20	BBN001547320190000.	372,50	434,30	599,00
750	300	BBN001567510190000.	877,60	1.028,60	1.432,20	BBN001567320190000.	449,70	525,20	727,00
750	400	BBN001587510190000.	1.264,60	1.484,20	2.069,20	BBN001587320190000.	643,20	753,00	1.045,50
900	250	BBN001549510190000.	723,20	846,80	1.176,20	BBN001549320190000.	372,50	434,30	599,00
900	300	BBN001569510190000.	877,60	1.028,60	1.432,20	BBN001569320190000.	449,70	525,20	727,00
900	400	BBN001589510190000.	1.264,60	1.484,20	2.069,20	BBN001589320190000.	643,20	753,00	1.045,50
1000	250	BBN001541510190000.	723,20	846,80	1.176,20	BBN001541320190000.	372,50	434,30	599,00
1000	300	BBN001561510190000.	877,60	1.028,60	1.432,20	BBN001561320190000.	449,70	525,20	727,00
1000	400	BBN001581510190000.	1.264,60	1.484,20	2.069,20	BBN001581320190000.	643,20	753,00	1.045,50

H1820 mm

Module mm	Shelf depth mm	Item no. Freestanding bay	Melamine EUR	Painted EUR	Veneer EUR	Item no. Intermediate bay	Melamine EUR	Painted EUR	Veneer EUR
500	250	BBN001645510190000.	848,80	995,20	1.385,40	BBN001645320190000.	435,30	508,50	703,60
500	300	BBN001665510190000.	1.032,80	1.211,80	1.687,40	BBN001665320190000.	527,30	616,80	854,60
500	400	BBN001685510190000.	1.492,40	1.752,20	2.445,20	BBN001685320190000.	757,10	887,00	1.233,50
750	250	BBN001647510190000.	848,80	995,20	1.385,40	BBN001647320190000.	435,30	508,50	703,60
750	300	BBN001667510190000.	1.032,80	1.211,80	1.687,40	BBN001667320190000.	527,30	616,80	854,60
750	400	BBN001687510190000.	1.492,40	1.752,20	2.445,20	BBN001687320190000.	757,10	887,00	1.233,50
900	250	BBN001649510190000.	848,80	995,20	1.385,40	BBN001649320190000.	435,30	508,50	703,60
900	300	BBN001669510190000.	1.032,80	1.211,80	1.687,40	BBN001669320190000.	527,30	616,80	854,60
900	400	BBN001689510190000.	1.492,40	1.752,20	2.445,20	BBN001689320190000.	757,10	887,00	1.233,50
1000	250	BBN001641510190000.	848,80	995,20	1.385,40	BBN001641320190000.	435,30	508,50	703,60
1000	300	BBN001661510190000.	1.032,80	1.211,80	1.687,40	BBN001661320190000.	527,30	616,80	854,60
1000	400	BBN001681510190000.	1.492,40	1.752,20	2.445,20	BBN001681320190000.	757,10	887,00	1.233,50

H2120 mm

Module mm	Shelf depth mm	Item no. Freestanding bay	Melamine EUR	Painted EUR	Veneer EUR	Item no. Intermediate bay	Melamine EUR	Painted EUR	Veneer EUR
500	250	BBN001745510190000.	956,20	1.120,80	1.561,20	BBN001745320190000.	489,00	571,30	791,50
500	300	BBN001765510190000.	1.182,80	1.388,00	1.934,40	BBN001765320190000.	602,30	704,90	978,10
500	400	BBN001785510190000.	1.711,60	2.009,00	2.804,40	BBN001785320190000.	866,70	1.015,40	1.413,10
750	250	BBN001747510190000.	956,20	1.120,80	1.561,20	BBN001747320190000.	489,00	571,30	791,50
750	300	BBN001767510190000.	1.182,80	1.388,00	1.934,40	BBN001767320190000.	602,30	704,90	978,10
750	400	BBN001787510190000.	1.711,60	2.009,00	2.804,40	BBN001787320190000.	866,70	1.015,40	1.413,10
900	250	BBN001749510190000.	956,20	1.120,80	1.561,20	BBN001749320190000.	489,00	571,30	791,50
900	300	BBN001769510190000.	1.182,80	1.388,00	1.934,40	BBN001769320190000.	602,30	704,90	978,10
900	400	BBN001789510190000.	1.711,60	2.009,00	2.804,40	BBN001789320190000.	866,70	1.015,40	1.413,10
1000	250	BBN001741510190000.	956,20	1.120,80	1.561,20	BBN001741320190000.	489,00	571,30	791,50
1000	300	BBN001761510190000.	1.182,80	1.388,00	1.934,40	BBN001761320190000.	602,30	704,90	978,10
1000	400	BBN001781510190000.	1.711,60	2.009,00	2.804,40	BBN001781320190000.	866,70	1.015,40	1.413,10

LINGO SHELVING SYSTEM

BBN002 - STEEL BACK FRAME - ADJUSTABLE FEET - WITH OVERLAYING WOODEN TOP PLATE



LINGO SHELVING SYSTEM

BBN002 - STEEL BACK FRAME - ADJUSTABLE FEET - WITH OVERLAYING WOODEN TOP PLATE

Shelving system with wooden panels, steel back frame and overlaying top plate.
For configurations with more than 3 bays, please contact Customer Service.

- Prices based on steel price group 1 and wooden price group A (see Design Options pages 6-9).
- For shelves see page 144 & 166.
- For accessories see page 186.

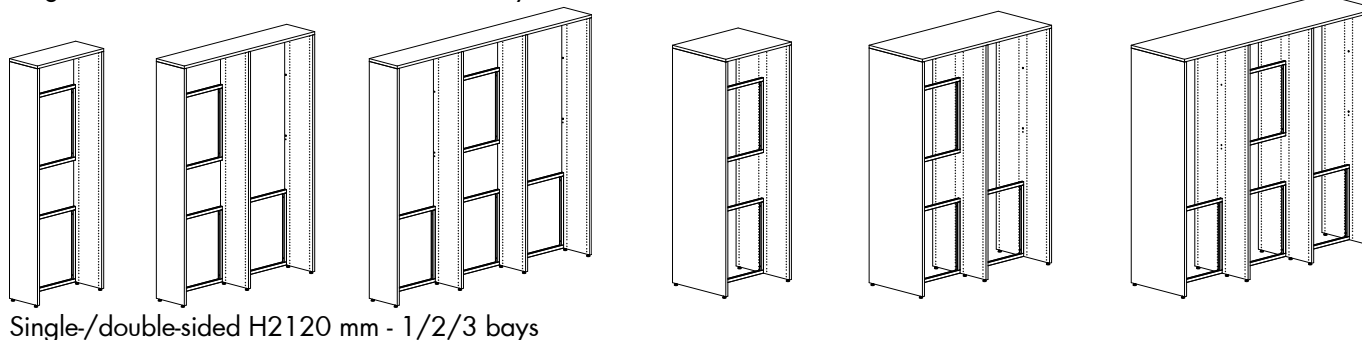
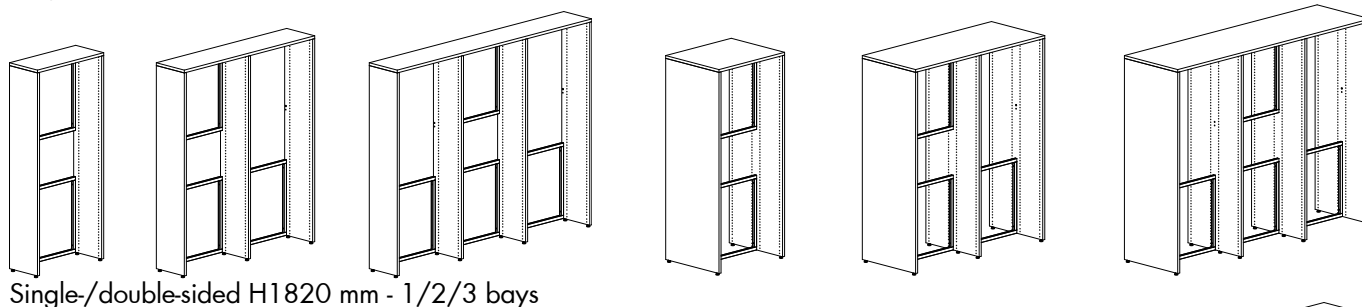
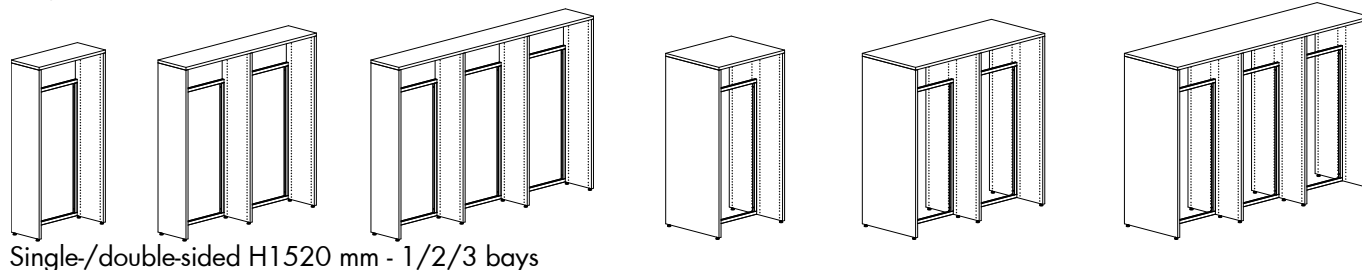
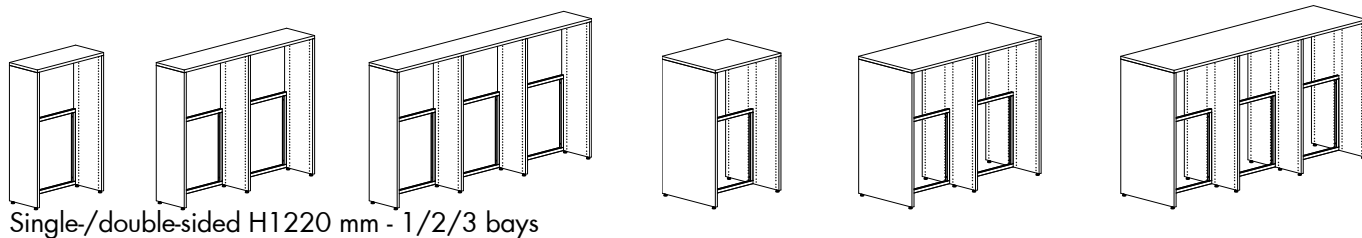
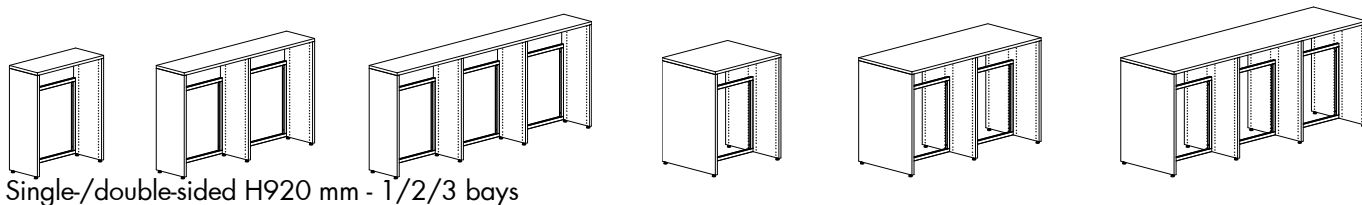
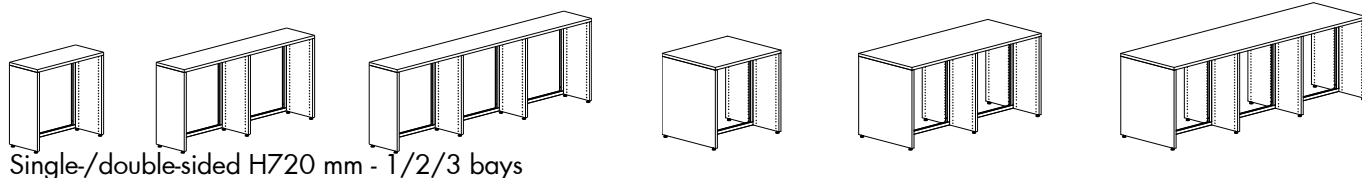

LINGO SHELVING SYSTEM

SINGLE-SIDED - STEEL BACK FRAME - ADJUSTABLE FEET - WITH OVERLAYING WOODEN TOP PLATE

Painted and veneered Lingo Shelving Systems are FSC-certified. Configurations with more than 2/3 bays are available.

H720 mm

Module mm	Shelf depth mm	Bays	Item no.	Melamine EUR	Painted EUR	Veneer EUR
500	250	1	BBN00223551016000.	440	503,80	674,80
500	250	2	BBN00223551026000.	731	832,80	1.104,20
500	250	3	BBN00223551036000.	1.033	1.174,10	1.550,90
500	300	1	BBN00225551016000.	489	560,80	754,70
500	300	2	BBN00225551026000.	808	922,50	1.229,60
500	300	3	BBN00225551036000.	1.139	1.297,80	1.724,30
500	400	1	BBN00227551016000.	605	697,30	945,40
500	400	2	BBN00227551026000.	985	1.131,00	1.520,80
500	400	3	BBN00227551036000.	1.378	1.580,20	2.118,50
750	250	1	BBN00223751016000.	493	566,70	762,50
750	250	2	BBN00223751026000.	827	945,50	1.261,50
750	250	3	BBN00223751036000.	1.176	1.343,00	1.787,40
750	300	1	BBN00225751016000.	548	630,80	852,60
750	300	2	BBN00225751026000.	914	1.047,40	1.405,30
750	300	3	BBN00225751036000.	1.299	1.485,60	1.987,90
750	400	1	BBN00227751016000.	670	774,10	1.052,50
750	400	2	BBN00227751026000.	1.102	1.269,00	1.713,90
750	400	3	BBN00227751036000.	1.554	1.787,30	2.408,60
900	250	1	BBN00223951016000.	493	566,70	762,50
900	250	2	BBN00223951026000.	827	945,50	1.261,50
900	300	1	BBN00225951016000.	548	630,80	852,60
900	300	2	BBN00225951026000.	914	1.047,40	1.405,30
900	400	1	BBN00227951016000.	670	774,10	1.052,50
900	400	2	BBN00227951026000.	1.102	1.269,00	1.713,90
1000	250	1	BBN00223151016000.	521	598,30	802,50
1000	250	2	BBN00223151026000.	879	1.003,90	1.335,40
1000	300	1	BBN00225151016000.	579	664,50	895,50
1000	300	2	BBN00225151026000.	971	1.110,40	1.485,10
1000	400	1	BBN00227151016000.	702	810,00	1.099,00
1000	400	2	BBN00227151026000.	1.162	1.336,30	1.799,20

LINGO SHELVING SYSTEM

SINGLE-SIDED - STEEL BACK FRAME - ADJUSTABLE FEET - WITH OVERLAYING WOODEN TOP PLATE

Painted and veneered Lingo Shelving Systems are FSC-certified. Configurations with more than 2/3 bays are available.

H920 mm

Module mm	Shelf depth mm	Bays	Item no.	Melamine EUR	Painted EUR	Veneer EUR
500	250	1	BBN00233551016000.	511	587,80	791,00
500	250	2	BBN00233551026000.	838	958,80	1.278,50
500	250	3	BBN00233551036000.	1.176	1.342,10	1.783,30
500	300	1	BBN00235551016000.	570	656,80	888,90
500	300	2	BBN00235551026000.	930	1.066,50	1.430,90
500	300	3	BBN00235551036000.	1.302	1.489,80	1.992,70
500	400	1	BBN00237551016000.	715	826,30	1.126,40
500	400	2	BBN00237551026000.	1.150	1.324,50	1.792,30
500	400	3	BBN00237551036000.	1.599	1.838,20	2.480,50
750	250	1	BBN00233751016000.	565	650,70	878,70
750	250	2	BBN00233751026000.	934	1.071,50	1.435,80
750	250	3	BBN00233751036000.	1.319	1.511,00	2.019,80
750	300	1	BBN00235751016000.	630	726,80	986,80
750	300	2	BBN00235751026000.	1.037	1.191,40	1.606,60
750	300	3	BBN00235751036000.	1.462	1.677,60	2.256,30
750	400	1	BBN00237751016000.	780	903,10	1.233,50
750	400	2	BBN00237751026000.	1.267	1.462,50	1.985,40
750	400	3	BBN00237751036000.	1.774	2.045,30	2.770,60
900	250	1	BBN00233951016000.	565	650,70	878,70
900	250	2	BBN00233951026000.	934	1.071,50	1.435,80
900	300	1	BBN00235951016000.	630	726,80	986,80
900	300	2	BBN00235951026000.	1.037	1.191,40	1.606,60
900	400	1	BBN00237951016000.	780	903,10	1.233,50
900	400	2	BBN00237951026000.	1.267	1.462,50	1.985,40
1000	250	1	BBN00233151016000.	593	682,30	918,70
1000	250	2	BBN00233151026000.	987	1.129,90	1.509,70
1000	300	1	BBN00235151016000.	660	760,50	1.029,70
1000	300	2	BBN00235151026000.	1.093	1.254,40	1.686,40
1000	400	1	BBN00237151016000.	812	939,00	1.280,00
1000	400	2	BBN00237151026000.	1.328	1.529,80	2.070,70

LINGO SHELVING SYSTEM

SINGLE-SIDED - STEEL BACK FRAME - ADJUSTABLE FEET - WITH OVERLAYING WOODEN TOP PLATE

Painted and veneered Lingo Shelving Systems are FSC-certified. Configurations with more than 2/3 bays are available.

H1220 mm

Module mm	Shelf depth mm	No. of bays	Item no.	Melamine EUR	Painted EUR	Veneer EUR
500	250	1	BBN00243551016000.	617	711,60	966,00
500	250	2	BBN00243551026000.	997	1.144,50	1.541,00
500	250	3	BBN00243551036000.	1.387	1.589,70	2.133,30
500	300	1	BBN00245551016000.	648	748,00	1.015,50
500	300	2	BBN00245551026000.	1.046	1.203,30	1.620,80
500	300	3	BBN00245551036000.	1.457	1.672,20	2.245,90
500	400	1	BBN00247551016000.	863	1.001,30	1.370,60
500	400	2	BBN00247551026000.	1.372	1.587,00	2.158,60
500	400	3	BBN00247551036000.	1.895	2.188,20	2.968,90
750	250	1	BBN00243751016000.	671	774,50	1.053,70
750	250	2	BBN00243751026000.	1.093	1.257,20	1.698,30
750	250	3	BBN00243751036000.	1.531	1.758,60	2.369,80
750	300	1	BBN00245751016000.	707	818,00	1.113,40
750	300	2	BBN00245751026000.	1.153	1.328,20	1.796,50
750	300	3	BBN00245751036000.	1.617	1.860,00	2.509,50
750	400	1	BBN00247751016000.	928	1.078,10	1.477,70
750	400	2	BBN00247751026000.	1.490	1.725,00	2.351,70
750	400	3	BBN00247751036000.	2.071	2.395,30	3.259,00
900	250	1	BBN00243951016000.	671	774,50	1.053,70
900	250	2	BBN00243951026000.	1.093	1.257,20	1.698,30
900	300	1	BBN00245951016000.	707	818,00	1.113,40
900	300	2	BBN00245951026000.	1.153	1.328,20	1.796,50
900	400	1	BBN00247951016000.	928	1.078,10	1.477,70
900	400	2	BBN00247951026000.	1.490	1.725,00	2.351,70
1000	250	1	BBN00243151016000.	699	806,10	1.093,70
1000	250	2	BBN00243151026000.	1.145	1.315,60	1.772,20
1000	300	1	BBN00245151016000.	738	851,70	1.156,30
1000	300	2	BBN00245151026000.	1.210	1.391,20	1.876,30
1000	400	1	BBN00247151016000.	960	1.114,00	1.524,20
1000	400	2	BBN00247151026000.	1.550	1.792,30	2.437,00

LINGO SHELVING SYSTEM

SINGLE-SIDED - STEEL BACK FRAME - ADJUSTABLE FEET - WITH OVERLAYING WOODEN TOP PLATE

Painted and veneered Lingo Shelving Systems are FSC-certified. Configurations with more than 2/3 bays are available.

H1520 mm

Module mm	Shelf depth mm	No. of bays	Item no.	Melamine EUR	Painted EUR	Veneer EUR
500	250	1	BBN00253551016000.	700	805,10	1.086,50
500	250	2	BBN00253551026000.	1.132	1.296,50	1.733,50
500	250	3	BBN00253551036000.	1.576	1.800,20	2.397,80
500	300	1	BBN00255551016000.	730	841,30	1.135,80
500	300	2	BBN00255551026000.	1.181	1.355,00	1.813,00
500	300	3	BBN00255551036000.	1.645	1.882,30	2.510,00
500	400	1	BBN00257551016000.	987	1.142,20	1.557,90
500	400	2	BBN00257551026000.	1.569	1.810,10	2.451,30
500	400	3	BBN00257551036000.	2.166	2.493,50	3.367,00
750	250	1	BBN00253751016000.	753	868,00	1.174,20
750	250	2	BBN00253751026000.	1.228	1.409,20	1.890,80
750	250	3	BBN00253751036000.	1.719	1.969,10	2.634,30
750	300	1	BBN00255751016000.	789	911,30	1.233,70
750	300	2	BBN00255751026000.	1.288	1.479,90	1.988,70
750	300	3	BBN00255751036000.	1.804	2.070,10	2.773,60
750	400	1	BBN00257751016000.	1.052	1.219,00	1.665,00
750	400	2	BBN00257751026000.	1.687	1.948,10	2.644,40
750	400	3	BBN00257751036000.	2.341	2.700,60	3.657,10
900	250	1	BBN00253951016000.	753	868,00	1.174,20
900	250	2	BBN00253951026000.	1.228	1.409,20	1.890,80
900	300	1	BBN00255951016000.	789	911,30	1.233,70
900	300	2	BBN00255951026000.	1.288	1.479,90	1.988,70
900	400	1	BBN00257951016000.	1.052	1.219,00	1.665,00
900	400	2	BBN00257951026000.	1.687	1.948,10	2.644,40
1000	250	1	BBN00253151016000.	784	902,40	1.217,00
1000	250	2	BBN00253151026000.	1.287	1.473,20	1.970,30
1000	300	1	BBN00255151016000.	822	947,80	1.279,40
1000	300	2	BBN00255151026000.	1.350	1.548,50	2.074,10
1000	400	1	BBN00257151016000.	1.086	1.257,70	1.714,30
1000	400	2	BBN00257151026000.	1.753	2.021,00	2.735,30

LINGO SHELVING SYSTEM

SINGLE-SIDED - STEEL BACK FRAME - ADJUSTABLE FEET - WITH OVERLAYING WOODEN TOP PLATE

Painted and veneered Lingo Shelving Systems are FSC-certified. Configurations with more than 2/3 bays are available.

H1820 mm

Module mm	Shelf depth mm	Bays	Item no.	Melamine EUR	Painted EUR	Veneer EUR
500	250	1	BBN00263551016000.	761	881,20	1.202,80
500	250	2	BBN00263551026000.	1.213	1.398,90	1.896,20
500	250	3	BBN00263551036000.	1.675	1.928,90	2.606,90
500	300	1	BBN00265551016000.	786	911,20	1.243,30
500	300	2	BBN00265551026000.	1.254	1.448,10	1.962,50
500	300	3	BBN00265551036000.	1.734	1.998,60	2.701,50
500	400	1	BBN00267551016000.	1.072	1.246,50	1.715,00
500	400	2	BBN00267551026000.	1.685	1.954,80	2.675,20
500	400	3	BBN00267551036000.	2.312	2.678,60	3.657,70
750	250	1	BBN00263751016000.	814	944,10	1.290,50
750	250	2	BBN00263751026000.	1.308	1.511,60	2.053,50
750	250	3	BBN00263751036000.	1.819	2.097,80	2.843,40
750	300	1	BBN00265751016000.	846	981,20	1.341,20
750	300	2	BBN00265751026000.	1.360	1.573,00	2.138,20
750	300	3	BBN00265751036000.	1.893	2.186,40	2.965,10
750	400	1	BBN00267751016000.	1.137	1.323,30	1.822,10
750	400	2	BBN00267751026000.	1.803	2.092,80	2.868,30
750	400	3	BBN00267751036000.	2.488	2.885,70	3.947,80
900	250	1	BBN00263951016000.	814	944,10	1.290,50
900	250	2	BBN00263951026000.	1.308	1.511,60	2.053,50
900	300	1	BBN00265951016000.	846	981,20	1.341,20
900	300	2	BBN00265951026000.	1.360	1.573,00	2.138,20
900	400	1	BBN00267951016000.	1.137	1.323,30	1.822,10
900	400	2	BBN00267951026000.	1.803	2.092,80	2.868,30
1000	250	1	BBN00263151016000.	843	975,70	1.330,50
1000	250	2	BBN00263151026000.	1.361	1.570,00	2.127,40
1000	300	1	BBN00265151016000.	876	1.014,90	1.384,10
1000	300	2	BBN00265151026000.	1.417	1.636,00	2.218,00
1000	400	1	BBN00267151016000.	1.169	1.359,20	1.868,60
1000	400	2	BBN00267151026000.	1.863	2.160,10	2.953,60

LINGO SHELVING SYSTEM

SINGLE-SIDED - STEEL BACK FRAME - ADJUSTABLE FEET - WITH OVERLAYING WOODEN TOP PLATE

Painted and veneered Lingo Shelving Systems are FSC-certified. Configurations with more than 2/3 bays are available.

H2120 mm

Module mm	Shelf depth mm	Bays	Item no.	Melamine EUR	Painted EUR	Veneer EUR
500	250	1	BBN00273551016000.	827	959,00	1.311,60
500	250	2	BBN00273551026000.	1.312	1.515,60	2.059,40
500	250	3	BBN00273551036000.	1.807	2.084,50	2.824,50
500	300	1	BBN00275551016000.	851	987,40	1.350,70
500	300	2	BBN00275551026000.	1.351	1.562,40	2.123,60
500	300	3	BBN00275551036000.	1.863	2.151,00	2.916,30
500	400	1	BBN00277551016000.	1.156	1.345,30	1.851,80
500	400	2	BBN00277551026000.	1.811	2.103,00	2.880,40
500	400	3	BBN00277551036000.	2.480	2.876,20	3.931,30
750	250	1	BBN00273751016000.	880	1.021,90	1.399,30
750	250	2	BBN00273751026000.	1.407	1.628,30	2.216,70
750	250	3	BBN00273751036000.	1.951	2.253,40	3.061,00
750	300	1	BBN00275751016000.	910	1.057,40	1.448,60
750	300	2	BBN00275751026000.	1.457	1.687,30	2.299,30
750	300	3	BBN00275751036000.	2.023	2.338,80	3.179,90
750	400	1	BBN00277751016000.	1.221	1.422,10	1.958,90
750	400	2	BBN00277751026000.	1.928	2.241,00	3.073,50
750	400	3	BBN00277751036000.	2.656	3.083,30	4.221,40
900	250	1	BBN00273951016000.	880	1.021,90	1.399,30
900	250	2	BBN00273951026000.	1.407	1.628,30	2.216,70
900	300	1	BBN00275951016000.	910	1.057,40	1.448,60
900	300	2	BBN00275951026000.	1.457	1.687,30	2.299,30
900	400	1	BBN00277951016000.	1.221	1.422,10	1.958,90
900	400	2	BBN00277951026000.	1.928	2.241,00	3.073,50
1000	250	1	BBN00273151016000.	909	1.053,50	1.439,30
1000	250	2	BBN00273151026000.	1.460	1.686,70	2.290,60
1000	300	1	BBN00275151016000.	941	1.091,10	1.491,50
1000	300	2	BBN00275151026000.	1.514	1.750,30	2.379,10
1000	400	1	BBN00277151016000.	1.253	1.458,00	2.005,40
1000	400	2	BBN00277151026000.	1.989	2.308,30	3.158,80

LINGO SHELVING SYSTEM

DOUBLE-SIDED - STEEL BACK FRAME - ADJUSTABLE FEET - WITH OVERLAYING WOODEN TOP PLATE

Painted and veneered Lingo Shelving Systems are FSC-certified. Configurations with more than 2/3 bays are available.

H720 mm

Module mm	Shelf depth mm	No. of bays	Item no.	Melamine EUR	Painted EUR	Veneer EUR
500	250	1	BBN00224551016000.	615	709,80	961,90
500	250	2	BBN00224551026000.	1.011	1.161,40	1.562,80
500	250	3	BBN00224551036000.	1.424	1.632,80	2.191,90
500	300	1	BBN00226551016000.	750	867,90	1.184,20
500	300	2	BBN00226551026000.	1.218	1.405,10	1.905,20
500	300	3	BBN00226551036000.	1.705	1.964,10	2.657,00
500	400	1	BBN00228551016000.	990	1.150,00	1.579,30
500	400	2	BBN00228551026000.	1.583	1.835,00	2.506,60
500	400	3	BBN00228551036000.	2.198	2.543,70	3.467,90
750	250	1	BBN00224751016000.	697	806,70	1.097,20
750	250	2	BBN00224751026000.	1.159	1.335,30	1.806,40
750	250	3	BBN00224751036000.	1.645	1.893,10	2.556,20
750	300	1	BBN00226751016000.	841	975,30	1.334,50
750	300	2	BBN00226751026000.	1.382	1.598,00	2.175,40
750	300	3	BBN00226751036000.	1.952	2.253,70	3.062,50
750	400	1	BBN00228751016000.	1.090	1.268,20	1.744,60
750	400	2	BBN00228751026000.	1.764	2.047,20	2.804,00
750	400	3	BBN00228751036000.	2.469	2.862,40	3.913,60
900	250	1	BBN00224951016000.	697	806,70	1.097,20
900	250	2	BBN00224951026000.	1.159	1.335,30	1.806,40
900	300	1	BBN00226951016000.	841	975,30	1.334,50
900	300	2	BBN00226951026000.	1.382	1.598,00	2.175,40
900	400	1	BBN00228951016000.	1.090	1.268,20	1.744,60
900	400	2	BBN00228951026000.	1.764	2.047,20	2.804,00
1000	250	1	BBN00224151016000.	735	849,00	1.152,80
1000	250	2	BBN00224151026000.	1.229	1.413,80	1.908,10
1000	300	1	BBN00226151016000.	882	1.021,60	1.394,80
1000	300	2	BBN00226151026000.	1.458	1.683,30	2.286,30
1000	400	1	BBN00228151016000.	1.134	1.317,80	1.809,70
1000	400	2	BBN00228151026000.	1.845	2.138,60	2.924,10

LINGO SHELVING SYSTEM

DOUBLE-SIDED - STEEL BACK FRAME - ADJUSTABLE FEET - WITH OVERLAYING WOODEN TOP PLATE

Painted and veneered Lingo Shelving Systems are FSC-certified. Configurations with more than 2/3 bays are available.

H920 mm

Module mm	Shelf depth mm	No. of bays	Item no.	Melamine EUR	Painted EUR	Veneer EUR
500	250	1	BBN00234551016000.	719	831,40	1.132,30
500	250	2	BBN00234551026000.	1.166	1.343,80	1.818,40
500	250	3	BBN00234551036000.	1.630	1.876,00	2.532,70
500	300	1	BBN00236551016000.	886	1.028,50	1.408,60
500	300	2	BBN00236551026000.	1.422	1.646,00	2.241,80
500	300	3	BBN00236551036000.	1.977	2.285,30	3.105,80
500	400	1	BBN00238551016000.	1.187	1.382,00	1.903,70
500	400	2	BBN00238551026000.	1.879	2.183,00	2.993,20
500	400	3	BBN00238551036000.	2.592	3.007,70	4.116,70
750	250	1	BBN00234751016000.	801	928,30	1.267,60
750	250	2	BBN00234751026000.	1.314	1.517,70	2.062,00
750	250	3	BBN00234751036000.	1.851	2.136,30	2.897,00
750	300	1	BBN00236751016000.	977	1.135,90	1.558,90
750	300	2	BBN00236751026000.	1.586	1.838,90	2.512,00
750	300	3	BBN00236751036000.	2.224	2.574,90	3.511,30
750	400	1	BBN00238751016000.	1.287	1.500,20	2.069,00
750	400	2	BBN00238751026000.	2.060	2.395,20	3.290,60
750	400	3	BBN00238751036000.	2.863	3.326,40	4.562,40
900	250	1	BBN00234951016000.	801	928,30	1.267,60
900	250	2	BBN00234951026000.	1.314	1.517,70	2.062,00
900	300	1	BBN00236951016000.	977	1.135,90	1.558,90
900	300	2	BBN00236951026000.	1.586	1.838,90	2.512,00
900	400	1	BBN00238951016000.	1.287	1.500,20	2.069,00
900	400	2	BBN00238951026000.	2.060	2.395,20	3.290,60
1000	250	1	BBN00234151016000.	839	970,60	1.323,20
1000	250	2	BBN00234151026000.	1.383	1.596,20	2.163,70
1000	300	1	BBN00236151016000.	1.018	1.182,20	1.619,20
1000	300	2	BBN00236151026000.	1.662	1.924,20	2.622,90
1000	400	1	BBN00238151016000.	1.331	1.549,80	2.134,10
1000	400	2	BBN00238151026000.	2.141	2.486,60	3.410,70

LINGO SHELVING SYSTEM

DOUBLE-SIDED - STEEL BACK FRAME - ADJUSTABLE FEET - WITH OVERLAYING WOODEN TOP PLATE

Painted and veneered Lingo Shelving Systems are FSC-certified. Configurations with more than 2/3 bays are available.

H1220 mm

Module mm	Shelf depth mm	No. of bays	Item no.	Melamine EUR	Painted EUR	Veneer EUR
500	250	1	BBN00244551016000.	871	1.010,40	1.383,50
500	250	2	BBN00244551026000.	1.394	1.612,30	2.195,20
500	250	3	BBN00244551036000.	1.934	2.234,00	3.035,10
500	300	1	BBN00246551016000.	1.073	1.248,30	1.717,20
500	300	2	BBN00246551026000.	1.703	1.975,70	2.704,70
500	300	3	BBN00246551036000.	2.352	2.724,90	3.723,00
500	400	1	BBN00248551016000.	1.459	1.703,00	2.353,90
500	400	2	BBN00248551026000.	2.288	2.664,50	3.668,50
500	400	3	BBN00248551036000.	3.137	3.649,70	5.017,10
750	250	1	BBN00244751016000.	953	1.107,30	1.518,80
750	250	2	BBN00244751026000.	1.542	1.786,20	2.438,80
750	250	3	BBN00244751036000.	2.155	2.494,30	3.399,40
750	300	1	BBN00246751016000.	1.165	1.355,70	1.867,50
750	300	2	BBN00246751026000.	1.867	2.168,60	2.974,90
750	300	3	BBN00246751036000.	2.598	3.014,50	4.128,50
750	400	1	BBN00248751016000.	1.560	1.821,20	2.519,20
750	400	2	BBN00248751026000.	2.468	2.876,70	3.965,90
750	400	3	BBN00248751036000.	3.408	3.968,40	5.462,80
900	250	1	BBN00244951016000.	953	1.107,30	1.518,80
900	250	2	BBN00244951026000.	1.542	1.786,20	2.438,80
900	300	1	BBN00246951016000.	1.165	1.355,70	1.867,50
900	300	2	BBN00246951026000.	1.867	2.168,60	2.974,90
900	400	1	BBN00248951016000.	1.560	1.821,20	2.519,20
900	400	2	BBN00248951026000.	2.468	2.876,70	3.965,90
1000	250	1	BBN00244151016000.	991	1.149,60	1.574,40
1000	250	2	BBN00244151026000.	1.611	1.864,70	2.540,50
1000	300	1	BBN00246151016000.	1.205	1.402,00	1.927,80
1000	300	2	BBN00246151026000.	1.943	2.253,90	3.085,80
1000	400	1	BBN00248151016000.	1.604	1.870,80	2.584,30
1000	400	2	BBN00248151026000.	2.549	2.968,10	4.086,00

LINGO SHELVING SYSTEM

DOUBLE-SIDED - STEEL BACK FRAME - ADJUSTABLE FEET - WITH OVERLAYING WOODEN TOP PLATE

Painted and veneered Lingo Shelving Systems are FSC-certified. Configurations with more than 2/3 bays are available.

H1520 mm

Module mm	Shelf depth mm	No. of bays	Item no.	Melamine EUR	Painted EUR	Veneer EUR
500	250	1	BBN00254551016000.	968	1.119,90	1.526,20
500	250	2	BBN00254551026000.	1.551	1.788,30	2.421,00
500	250	3	BBN00254551036000.	2.151	2.476,50	3.344,00
500	300	1	BBN00256551016000.	1.140	1.323,00	1.812,30
500	300	2	BBN00256551026000.	1.815	2.099,50	2.859,10
500	300	3	BBN00256551036000.	2.509	2.897,80	3.936,70
500	400	1	BBN00258551016000.	1.545	1.799,90	2.479,40
500	400	2	BBN00258551026000.	2.428	2.821,60	3.868,50
500	400	3	BBN00258551036000.	3.332	3.867,00	5.291,60
750	250	1	BBN00254751016000.	1.049	1.216,80	1.661,50
750	250	2	BBN00254751026000.	1.699	1.962,20	2.664,60
750	250	3	BBN00254751036000.	2.372	2.736,80	3.708,30
750	300	1	BBN00256751016000.	1.231	1.430,40	1.962,60
750	300	2	BBN00256751026000.	1.979	2.292,40	3.129,30
750	300	3	BBN00256751036000.	2.755	3.187,40	4.342,20
750	400	1	BBN00258751016000.	1.646	1.918,10	2.644,70
750	400	2	BBN00258751026000.	2.609	3.033,80	4.165,90
750	400	3	BBN00258751036000.	3.603	4.185,70	5.737,30
900	250	1	BBN00254951016000.	1.049	1.216,80	1.661,50
900	250	2	BBN00254951026000.	1.699	1.962,20	2.664,60
900	300	1	BBN00256951016000.	1.231	1.430,40	1.962,60
900	300	2	BBN00256951026000.	1.979	2.292,40	3.129,30
900	400	1	BBN00258951016000.	1.646	1.918,10	2.644,70
900	400	2	BBN00258951026000.	2.609	3.033,80	4.165,90
1000	250	1	BBN00254151016000.	1.090	1.261,90	1.719,90
1000	250	2	BBN00254151026000.	1.774	2.046,30	2.771,90
1000	300	1	BBN00256151016000.	1.275	1.479,50	2.025,70
1000	300	2	BBN00256151026000.	2.060	2.383,30	3.245,80
1000	400	1	BBN00258151016000.	1.692	1.970,50	2.712,60
1000	400	2	BBN00258151026000.	2.695	3.130,80	4.291,60

LINGO SHELVING SYSTEM

DOUBLE-SIDED - STEEL BACK FRAME - ADJUSTABLE FEET - WITH OVERLAYING WOODEN TOP PLATE

Painted and veneered Lingo Shelving Systems are FSC-certified. Configurations with more than 2/3 bays are available.

H1820 mm

Module mm	Shelf depth mm	No. of bays	Item no.	Melamine EUR	Painted EUR	Veneer EUR
500	250	1	BBN00264551016000.	1.148	1.323,10	1.790,20
500	250	2	BBN00264551026000.	1.771	2.042,60	2.766,50
500	250	3	BBN00264551036000.	2.411	2.781,90	3.771,00
500	300	1	BBN00266551016000.	1.350	1.561,00	2.122,30
500	300	2	BBN00266551026000.	2.080	2.406,00	3.273,60
500	300	3	BBN00266551036000.	2.828	3.272,80	4.455,70
500	400	1	BBN00268551016000.	1.828	2.122,70	2.910,20
500	400	2	BBN00268551026000.	2.802	3.255,30	4.464,20
500	400	3	BBN00268551036000.	3.796	4.411,60	6.052,20
750	250	1	BBN00264751016000.	1.230	1.420,00	1.925,50
750	250	2	BBN00264751026000.	1.919	2.216,50	3.010,10
750	250	3	BBN00264751036000.	2.632	3.042,20	4.135,30
750	300	1	BBN00266751016000.	1.441	1.668,40	2.272,60
750	300	2	BBN00266751026000.	2.244	2.598,90	3.543,80
750	300	3	BBN00266751036000.	3.074	3.562,40	4.861,20
750	400	1	BBN00268751016000.	1.928	2.240,90	3.075,50
750	400	2	BBN00268751026000.	2.982	3.467,50	4.761,60
750	400	3	BBN00268751036000.	4.067	4.730,30	6.497,90
900	250	1	BBN00264951016000.	1.230	1.420,00	1.925,50
900	250	2	BBN00264951026000.	1.919	2.216,50	3.010,10
900	300	1	BBN00266951016000.	1.441	1.668,40	2.272,60
900	300	2	BBN00266951026000.	2.244	2.598,90	3.543,80
900	400	1	BBN00268951016000.	1.928	2.240,90	3.075,50
900	400	2	BBN00268951026000.	2.982	3.467,50	4.761,60
1000	250	1	BBN00264151016000.	1.278	1.472,80	1.991,60
1000	250	2	BBN00264151026000.	1.999	2.305,50	3.122,30
1000	300	1	BBN00266151016000.	1.493	1.725,20	2.343,40
1000	300	2	BBN00266151026000.	2.330	2.694,70	3.665,20
1000	400	1	BBN00268151016000.	1.982	2.301,00	3.151,10
1000	400	2	BBN00268151026000.	3.074	3.569,40	4.892,20

LINGO SHELVING SYSTEM

DOUBLE-SIDED - STEEL BACK FRAME - ADJUSTABLE FEET - WITH OVERLAYING WOODEN TOP PLATE

Painted and veneered Lingo Shelving Systems are FSC-certified. Configurations with more than 2/3 bays are available.

H2120 mm

Module mm	Shelf depth mm	No. of bays	Item no.	Melamine EUR	Painted EUR	Veneer EUR
500	250	1	BBN00274551016000.	1.255	1.448,70	1.966,00
500	250	2	BBN00274551026000.	1.932	2.231,00	3.030,20
500	250	3	BBN00274551036000.	2.626	3.033,10	4.122,60
500	300	1	BBN00276551016000.	1.500	1.737,20	2.369,30
500	300	2	BBN00276551026000.	2.305	2.670,30	3.644,10
500	300	3	BBN00276551036000.	3.128	3.625,20	4.949,70
500	400	1	BBN00278551016000.	2.047	2.379,50	3.269,40
500	400	2	BBN00278551026000.	3.131	3.640,50	5.003,00
500	400	3	BBN00278551036000.	4.235	4.925,20	6.770,60
750	250	1	BBN00274751016000.	1.337	1.545,60	2.101,30
750	250	2	BBN00274751026000.	2.080	2.404,90	3.273,80
750	250	3	BBN00274751036000.	2.847	3.293,40	4.486,90
750	300	1	BBN00276751016000.	1.591	1.844,60	2.519,60
750	300	2	BBN00276751026000.	2.469	2.863,20	3.914,30
750	300	3	BBN00276751036000.	3.374	3.914,80	5.355,20
750	400	1	BBN00278751016000.	2.147	2.497,70	3.434,70
750	400	2	BBN00278751026000.	3.311	3.852,70	5.300,40
750	400	3	BBN00278751036000.	4.506	5.243,90	7.216,30
900	250	1	BBN00274951016000.	1.337	1.545,60	2.101,30
900	250	2	BBN00274951026000.	2.080	2.404,90	3.273,80
900	300	1	BBN00276951016000.	1.591	1.844,60	2.519,60
900	300	2	BBN00276951026000.	2.469	2.863,20	3.914,30
900	400	1	BBN00278951016000.	2.147	2.497,70	3.434,70
900	400	2	BBN00278951026000.	3.311	3.852,70	5.300,40
1000	250	1	BBN00274151016000.	1.386	1.598,40	2.167,40
1000	250	2	BBN00274151026000.	2.160	2.493,90	3.386,00
1000	300	1	BBN00276151016000.	1.643	1.901,40	2.590,40
1000	300	2	BBN00276151026000.	2.555	2.959,00	4.035,70
1000	400	1	BBN00278151016000.	2.202	2.557,80	3.510,30
1000	400	2	BBN00278151026000.	3.402	3.954,60	5.431,00

LINGO SHELVING SYSTEM

BBN002 - WOODEN BACK PANEL - ADJUSTABLE FEET - WITH OVERLAYING WOODEN TOP PLATE



LINGO SHELVING SYSTEM

BBN002 - WOODEN BACK PANEL - ADJUSTABLE FEET - WITH OVERLAYING WOODEN TOP PLATE

Shelving system with wooden panels, wooden back panel and overlaying top plate.
For configurations with more than 3 bays, please contact Customer Service.

- Prices based on steel price group 1 and wooden price group A (see Design Options pages 6-9).
- For shelves see page 144 & 166.
- For accessories see page 186.

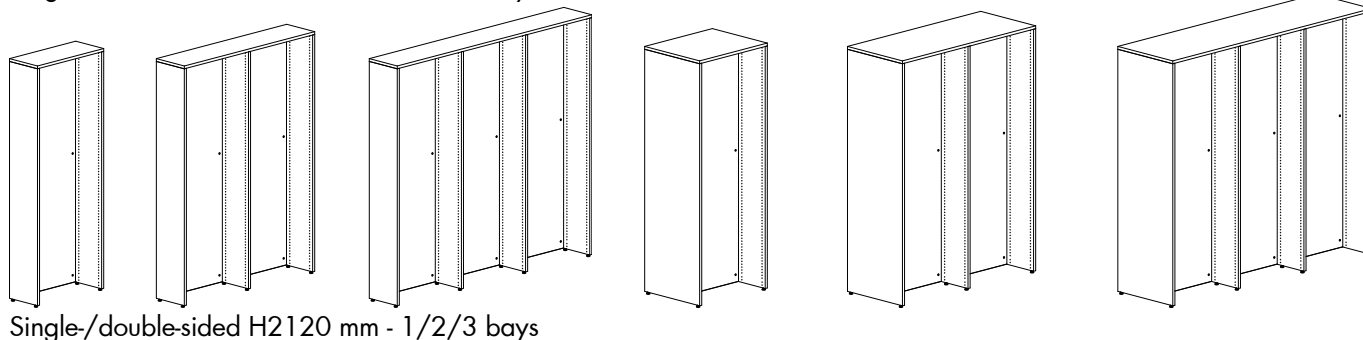
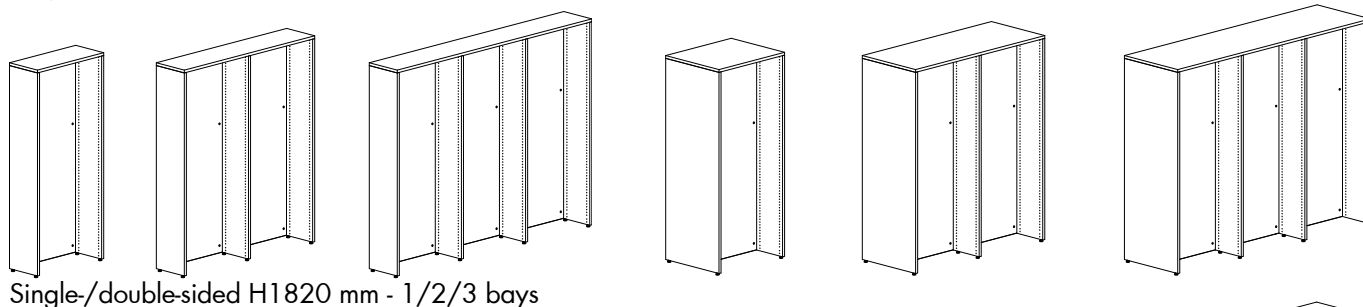
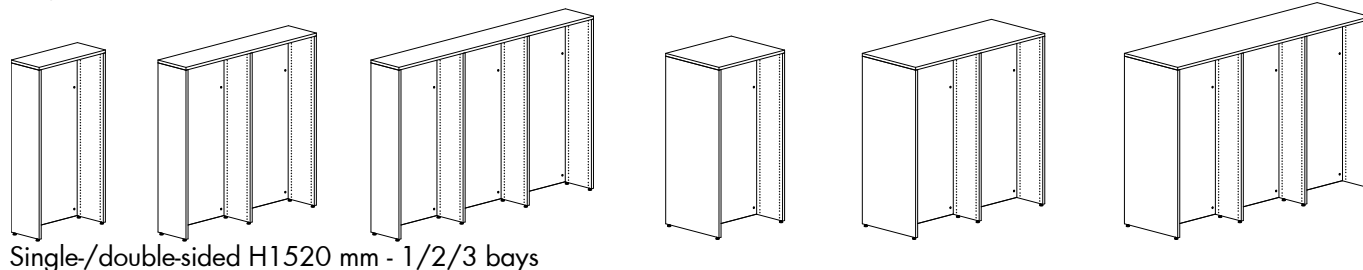
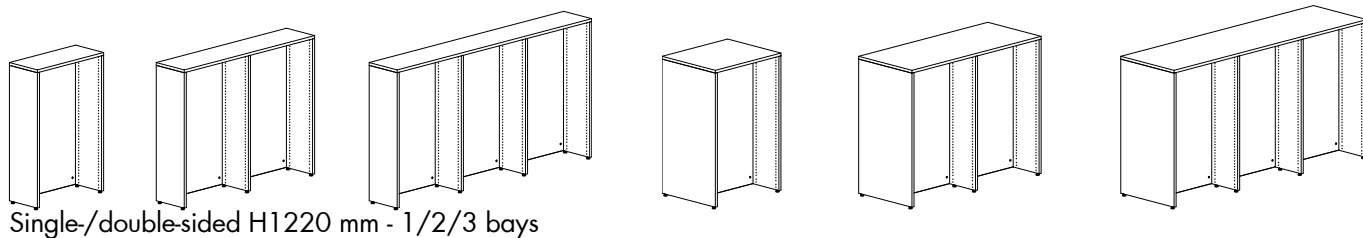
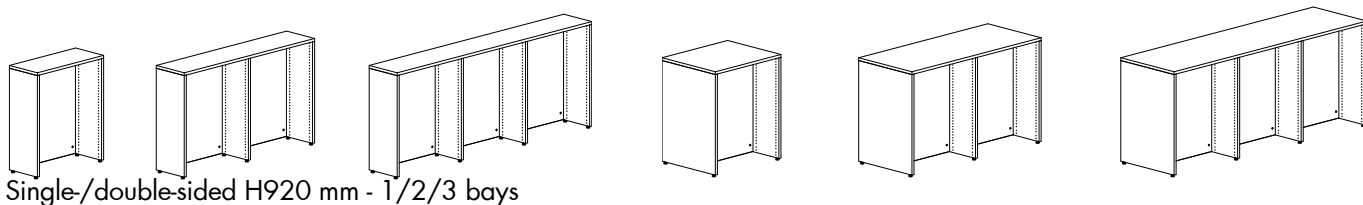
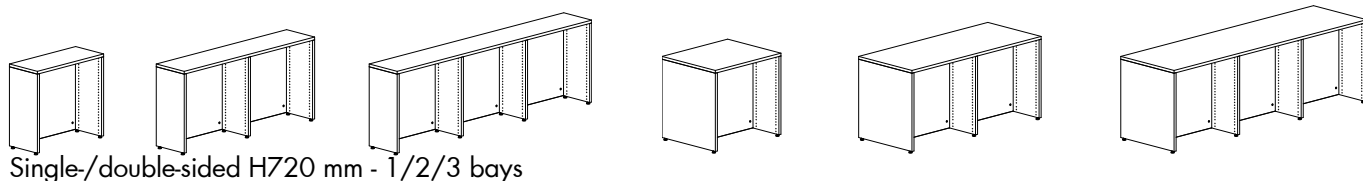

LINGO SHELVING SYSTEM

SINGLE-SIDED - WOODEN BACK PANEL - ADJUSTABLE FEET - WITH OVERLAYING WOODEN TOP PLATE

Painted and veneered Lingo Shelving Systems are FSC-certified. Configurations with more than 2/3 bays are available.

H720 mm

Module mm	Shelf depth mm	No. of bays	Item no.	Melamine EUR	Painted EUR	Veneer EUR
500	250	1	BBN00223551013000.	468	551,10	772,60
500	250	2	BBN00223551023000.	788	927,40	1.299,80
500	250	3	BBN00223551033000.	1.118	1.316,00	1.844,30
500	300	1	BBN00225551013000.	517	608,10	852,50
500	300	2	BBN00225551023000.	865	1.017,10	1.425,20
500	300	3	BBN00225551033000.	1.225	1.439,70	2.017,70
500	400	1	BBN00227551013000.	633	744,60	1.043,20
500	400	2	BBN00227551023000.	1.042	1.225,60	1.716,40
500	400	3	BBN00227551033000.	1.464	1.722,10	2.411,90
750	250	1	BBN00223751013000.	575	677,00	948,80
750	250	2	BBN00223751023000.	990	1.166,10	1.634,10
750	250	3	BBN00223751033000.	1.422	1.673,90	2.346,30
750	300	1	BBN00225751013000.	630	741,10	1.038,90
750	300	2	BBN00225751023000.	1.078	1.268,00	1.777,90
750	300	3	BBN00225751033000.	1.544	1.816,50	2.546,80
750	400	1	BBN00227751013000.	752	884,40	1.238,80
750	400	2	BBN00227751023000.	1.266	1.489,60	2.086,50
750	400	3	BBN00227751033000.	1.800	2.118,20	2.967,50
900	250	1	BBN00223951013000.	615	723,90	1.014,20
900	250	2	BBN00223951023000.	1.071	1.259,90	1.764,90
900	300	1	BBN00225951013000.	670	788,00	1.104,30
900	300	2	BBN00225951023000.	1.158	1.361,80	1.908,70
900	400	1	BBN00227951013000.	792	931,30	1.304,20
900	400	2	BBN00227951023000.	1.346	1.583,40	2.217,30
1000	250	1	BBN00223151013000.	646	761,00	1.065,60
1000	250	2	BBN00223151023000.	1.129	1.329,30	1.861,60
1000	300	1	BBN00225151013000.	703	827,20	1.158,60
1000	300	2	BBN00225151023000.	1.221	1.435,80	2.011,30
1000	400	1	BBN00227151013000.	827	972,70	1.362,10
1000	400	2	BBN00227151023000.	1.412	1.661,70	2.325,40

LINGO SHELVING SYSTEM

SINGLE-SIDED - WOODEN BACK PANEL - ADJUSTABLE FEET - WITH OVERLAYING WOODEN TOP PLATE

Painted and veneered Lingo Shelving Systems are FSC-certified. Configurations with more than 2/3 bays are available.

H920 mm

Module mm	Shelf depth mm	No. of bays	Item no.	Melamine EUR	Painted EUR	Veneer EUR
500	250	1	BBN00233551013000.	570	670,30	938,20
500	250	2	BBN00233551023000.	955	1.123,80	1.572,90
500	250	3	BBN00233551033000.	1.351	1.589,60	2.224,90
500	300	1	BBN00235551013000.	628	739,30	1.036,10
500	300	2	BBN00235551023000.	1.047	1.231,50	1.725,30
500	300	3	BBN00235551033000.	1.477	1.737,30	2.434,30
500	400	1	BBN00237551013000.	773	908,80	1.273,60
500	400	2	BBN00237551023000.	1.267	1.489,50	2.086,70
500	400	3	BBN00237551033000.	1.774	2.085,70	2.922,10
750	250	1	BBN00233751013000.	691	813,50	1.138,10
750	250	2	BBN00233751023000.	1.187	1.397,10	1.954,60
750	250	3	BBN00233751033000.	1.699	1.999,40	2.798,00
750	300	1	BBN00235751013000.	756	889,60	1.246,20
750	300	2	BBN00235751023000.	1.290	1.517,00	2.125,40
750	300	3	BBN00235751033000.	1.842	2.166,00	3.034,50
750	400	1	BBN00237751013000.	907	1.065,90	1.492,90
750	400	2	BBN00237751023000.	1.521	1.788,10	2.504,20
750	400	3	BBN00237751033000.	2.154	2.533,70	3.548,80
900	250	1	BBN00233951013000.	743	873,90	1.222,50
900	250	2	BBN00233951023000.	1.290	1.517,90	2.123,40
900	300	1	BBN00235951013000.	808	950,00	1.330,60
900	300	2	BBN00235951023000.	1.392	1.637,80	2.294,20
900	400	1	BBN00237951013000.	958	1.126,30	1.577,30
900	400	2	BBN00237951023000.	1.623	1.908,90	2.673,00
1000	250	1	BBN00233151013000.	777	914,90	1.279,30
1000	250	2	BBN00233151023000.	1.356	1.595,10	2.230,90
1000	300	1	BBN00235151013000.	845	993,10	1.390,30
1000	300	2	BBN00235151023000.	1.462	1.719,60	2.407,60
1000	400	1	BBN00237151013000.	996	1.171,60	1.640,60
1000	400	2	BBN00237151023000.	1.696	1.995,00	2.791,90

LINGO SHELVING SYSTEM

SINGLE-SIDED - WOODEN BACK PANEL - ADJUSTABLE FEET - WITH OVERLAYING WOODEN TOP PLATE

Painted and veneered Lingo Shelving Systems are FSC-certified. Configurations with more than 2/3 bays are available.

H1220 mm

Module mm	Shelf depth mm	No. of bays	Item no.	Melamine EUR	Painted EUR	Veneer EUR
500	250	1	BBN00243551013000.	721	848,00	1.188,40
500	250	2	BBN00243551023000.	1.205	1.417,30	1.985,80
500	250	3	BBN00243551033000.	1.699	1.998,90	2.800,50
500	300	1	BBN00245551013000.	752	884,40	1.237,90
500	300	2	BBN00245551023000.	1.254	1.476,10	2.065,60
500	300	3	BBN00245551033000.	1.769	2.081,40	2.913,10
500	400	1	BBN00247551013000.	967	1.137,70	1.593,00
500	400	2	BBN00247551023000.	1.580	1.859,80	2.603,40
500	400	3	BBN00247551033000.	2.207	2.597,40	3.636,10
750	250	1	BBN00243751013000.	866	1.018,40	1.426,20
750	250	2	BBN00243751023000.	1.484	1.745,00	2.443,30
750	250	3	BBN00243751033000.	2.118	2.490,30	3.487,30
750	300	1	BBN00245751013000.	903	1.061,90	1.485,90
750	300	2	BBN00245751023000.	1.544	1.816,00	2.541,50
750	300	3	BBN00245751033000.	2.204	2.591,70	3.627,00
750	400	1	BBN00247751013000.	1.124	1.322,00	1.850,20
750	400	2	BBN00247751023000.	1.881	2.212,80	3.096,70
750	400	3	BBN00247751033000.	2.658	3.127,00	4.376,50
900	250	1	BBN00243951013000.	923	1.084,90	1.520,00
900	250	2	BBN00243951023000.	1.597	1.878,00	2.630,90
900	300	1	BBN00245951013000.	959	1.128,40	1.579,70
900	300	2	BBN00245951023000.	1.657	1.949,00	2.729,10
900	400	1	BBN00247951013000.	1.180	1.388,50	1.944,00
900	400	2	BBN00247951023000.	1.994	2.345,80	3.284,30
1000	250	1	BBN00243151013000.	975	1.146,20	1.605,00
1000	250	2	BBN00243151023000.	1.697	1.995,80	2.794,80
1000	300	1	BBN00245151013000.	1.013	1.191,80	1.667,60
1000	300	2	BBN00245151023000.	1.761	2.071,40	2.898,90
1000	400	1	BBN00247151013000.	1.236	1.454,10	2.035,50
1000	400	2	BBN00247151023000.	2.102	2.472,50	3.459,60

LINGO SHELVING SYSTEM

SINGLE-SIDED - WOODEN BACK PANEL - ADJUSTABLE FEET - WITH OVERLAYING WOODEN TOP PLATE

Painted and veneered Lingo Shelving Systems are FSC-certified. Configurations with more than 2/3 bays are available.

H1520 mm

Module mm	Shelf depth mm	No. of bays	Item no.	Melamine EUR	Painted EUR	Veneer EUR
500	250	1	BBN00253551013000.	821	965,90	1.352,60
500	250	2	BBN00253551023000.	1.375	1.618,10	2.265,70
500	250	3	BBN00253551033000.	1.940	2.282,60	3.196,10
500	300	1	BBN00255551013000.	851	1.002,10	1.401,90
500	300	2	BBN00255551023000.	1.424	1.676,60	2.345,20
500	300	3	BBN00255551033000.	2.009	2.364,70	3.308,30
500	400	1	BBN00257551013000.	1.108	1.303,00	1.824,00
500	400	2	BBN00257551023000.	1.812	2.131,70	2.983,50
500	400	3	BBN00257551033000.	2.530	2.975,90	4.165,30
750	250	1	BBN00253751013000.	986	1.160,30	1.624,00
750	250	2	BBN00253751023000.	1.694	1.993,80	2.790,40
750	250	3	BBN00253751033000.	2.419	2.846,00	3.983,70
750	300	1	BBN00255751013000.	1.022	1.203,60	1.683,50
750	300	2	BBN00255751023000.	1.754	2.064,50	2.888,30
750	300	3	BBN00255751033000.	2.504	2.947,00	4.123,00
750	400	1	BBN00257751013000.	1.285	1.511,30	2.114,80
750	400	2	BBN00257751023000.	2.153	2.532,70	3.544,00
750	400	3	BBN00257751033000.	3.041	3.577,50	5.006,50
900	250	1	BBN00253951013000.	1.061	1.247,90	1.747,30
900	250	2	BBN00253951023000.	1.843	2.169,00	3.037,00
900	300	1	BBN00255951013000.	1.097	1.291,20	1.806,80
900	300	2	BBN00255951023000.	1.903	2.239,70	3.134,90
900	400	1	BBN00257951013000.	1.359	1.598,90	2.238,10
900	400	2	BBN00257951023000.	2.302	2.707,90	3.790,60
1000	250	1	BBN00253151013000.	1.116	1.313,50	1.837,80
1000	250	2	BBN00253151023000.	1.951	2.295,40	3.211,90
1000	300	1	BBN00255151013000.	1.154	1.358,90	1.900,20
1000	300	2	BBN00255151023000.	2.014	2.370,70	3.315,70
1000	400	1	BBN00257151013000.	1.418	1.668,80	2.335,10
1000	400	2	BBN00257151023000.	2.417	2.843,20	3.976,90

LINGO SHELVING SYSTEM

SINGLE-SIDED - WOODEN BACK PANEL - ADJUSTABLE FEET - WITH OVERLAYING WOODEN TOP PLATE

Painted and veneered Lingo Shelving Systems are FSC-certified. Configurations with more than 2/3 bays are available.

H1820 mm

Module mm	Shelf depth mm	No. of bays	Item no.	Melamine EUR	Painted EUR	Veneer EUR
500	250	1	BBN00263551013000.	942	1.107,70	1.550,70
500	250	2	BBN00263551023000.	1.574	1.851,90	2.592,00
500	250	3	BBN00263551033000.	2.217	2.608,40	3.650,60
500	300	1	BBN00265551013000.	967	1.137,70	1.591,20
500	300	2	BBN00265551023000.	1.616	1.901,10	2.658,30
500	300	3	BBN00265551033000.	2.276	2.678,10	3.745,20
500	400	1	BBN00267551013000.	1.253	1.473,00	2.062,90
500	400	2	BBN00267551023000.	2.047	2.407,80	3.371,00
500	400	3	BBN00267551033000.	2.855	3.358,10	4.701,40
750	250	1	BBN00263751013000.	1.124	1.322,50	1.851,90
750	250	2	BBN00263751023000.	1.928	2.268,40	3.176,30
750	250	3	BBN00263751033000.	2.749	3.233,00	4.527,60
750	300	1	BBN00265751013000.	1.156	1.359,60	1.902,60
750	300	2	BBN00265751023000.	1.980	2.329,80	3.261,00
750	300	3	BBN00265751033000.	2.823	3.321,60	4.649,30
750	400	1	BBN00267751013000.	1.447	1.701,70	2.383,50
750	400	2	BBN00267751023000.	2.423	2.849,60	3.991,10
750	400	3	BBN00267751033000.	3.418	4.020,90	5.632,00
900	250	1	BBN00263951013000.	1.218	1.433,60	2.006,50
900	250	2	BBN00263951023000.	2.117	2.490,60	3.485,50
900	300	1	BBN00265951013000.	1.250	1.470,70	2.057,20
900	300	2	BBN00265951023000.	2.168	2.552,00	3.570,20
900	400	1	BBN00267951013000.	1.541	1.812,80	2.538,10
900	400	2	BBN00267951023000.	2.611	3.071,80	4.300,30
1000	250	1	BBN00263151013000.	1.271	1.495,80	2.094,20
1000	250	2	BBN00263151023000.	2.219	2.610,20	3.654,80
1000	300	1	BBN00265151013000.	1.305	1.535,00	2.147,80
1000	300	2	BBN00265151023000.	2.275	2.676,20	3.745,40
1000	400	1	BBN00267151013000.	1.598	1.879,30	2.632,30
1000	400	2	BBN00267151023000.	2.720	3.200,30	4.481,00

LINGO SHELVING SYSTEM

SINGLE-SIDED - WOODEN BACK PANEL - ADJUSTABLE FEET - WITH OVERLAYING WOODEN TOP PLATE

Painted and veneered Lingo Shelving Systems are FSC-certified. Configurations with more than 2/3 bays are available.

H2120 mm

Module mm	Shelf depth mm	No. of bays	Item no.	Melamine EUR	Painted EUR	Veneer EUR
500	250	1	BBN00273551013000.	1.048	1.232,60	1.726,30
500	250	2	BBN00273551023000.	1.754	2.062,80	2.888,80
500	250	3	BBN00273551033000.	2.470	2.905,30	4.068,60
500	300	1	BBN00275551013000.	1.072	1.261,00	1.765,40
500	300	2	BBN00275551023000.	1.793	2.109,60	2.953,00
500	300	3	BBN00275551033000.	2.527	2.971,80	4.160,40
500	400	1	BBN00277551013000.	1.377	1.618,90	2.266,50
500	400	2	BBN00277551023000.	2.253	2.650,20	3.709,80
500	400	3	BBN00277551033000.	3.143	3.697,00	5.175,40
750	250	1	BBN00273751013000.	1.251	1.471,60	2.059,60
750	250	2	BBN00273751023000.	2.148	2.527,70	3.537,30
750	250	3	BBN00273751033000.	3.061	3.602,50	5.041,90
750	300	1	BBN00275751013000.	1.281	1.507,10	2.108,90
750	300	2	BBN00275751023000.	2.198	2.586,70	3.619,90
750	300	3	BBN00275751033000.	3.134	3.687,90	5.160,80
750	400	1	BBN00277751013000.	1.591	1.871,80	2.619,20
750	400	2	BBN00277751023000.	2.669	3.140,40	4.394,10
750	400	3	BBN00277751033000.	3.766	4.432,40	6.202,30
900	250	1	BBN00273951013000.	1.359	1.598,60	2.238,40
900	250	2	BBN00273951023000.	2.364	2.781,70	3.894,90
900	300	1	BBN00275951013000.	1.389	1.634,10	2.287,70
900	300	2	BBN00275951023000.	2.414	2.840,70	3.977,50
900	400	1	BBN00277951013000.	1.699	1.998,80	2.798,00
900	400	2	BBN00277951023000.	2.885	3.394,40	4.751,70
1000	250	1	BBN00273151013000.	1.418	1.668,30	2.335,50
1000	250	2	BBN00273151023000.	2.478	2.916,30	4.083,00
1000	300	1	BBN00275151013000.	1.450	1.705,90	2.387,70
1000	300	2	BBN00275151023000.	2.533	2.979,90	4.171,50
1000	400	1	BBN00277151013000.	1.762	2.072,80	2.901,60
1000	400	2	BBN00277151023000.	3.007	3.537,90	4.951,20

LINGO SHELVING SYSTEM

DOUBLE-SIDED - WOODEN BACK PANEL - ADJUSTABLE FEET - WITH OVERLAYING WOODEN TOP PLATE

Painted and veneered Lingo Shelving Systems are FSC-certified. Configurations with more than 2/3 bays are available.

H720 mm

Module mm	Shelf depth mm	No. of bays	Item no.	Melamine EUR	Painted EUR	Veneer EUR
500	250	1	BBN00224551013000.	644	757,10	1.059,70
500	250	2	BBN00224551023000.	1.068	1.256,00	1.758,40
500	250	3	BBN00224551033000.	1.509	1.774,70	2.485,30
500	300	1	BBN00226551013000.	778	915,20	1.282,00
500	300	2	BBN00226551023000.	1.275	1.499,70	2.100,80
500	300	3	BBN00226551033000.	1.791	2.106,00	2.950,40
500	400	1	BBN00228551013000.	1.018	1.197,30	1.677,10
500	400	2	BBN00228551023000.	1.641	1.929,60	2.702,20
500	400	3	BBN00228551033000.	2.283	2.685,60	3.761,30
750	250	1	BBN00224751013000.	779	917,00	1.283,50
750	250	2	BBN00224751023000.	1.323	1.555,90	2.179,00
750	250	3	BBN00224751033000.	1.890	2.224,00	3.115,10
750	300	1	BBN00226751013000.	923	1.085,60	1.520,80
750	300	2	BBN00226751023000.	1.546	1.818,60	2.548,00
750	300	3	BBN00226751033000.	2.197	2.584,60	3.621,40
750	400	1	BBN00228751013000.	1.172	1.378,50	1.930,90
750	400	2	BBN00228751023000.	1.928	2.267,80	3.176,60
750	400	3	BBN00228751033000.	2.714	3.193,30	4.472,50
900	250	1	BBN00224951013000.	819	963,90	1.348,90
900	250	2	BBN00224951023000.	1.403	1.649,70	2.309,80
900	300	1	BBN00226951013000.	963	1.132,50	1.586,20
900	300	2	BBN00226951023000.	1.626	1.912,40	2.678,80
900	400	1	BBN00228951013000.	1.212	1.425,40	1.996,30
900	400	2	BBN00228951023000.	2.008	2.361,60	3.307,40
1000	250	1	BBN00224151013000.	860	1.011,70	1.415,90
1000	250	2	BBN00224151023000.	1.478	1.739,20	2.434,30
1000	300	1	BBN00226151013000.	1.007	1.184,30	1.657,90
1000	300	2	BBN00226151023000.	1.708	2.008,70	2.812,50
1000	400	1	BBN00228151013000.	1.259	1.480,50	2.072,80
1000	400	2	BBN00228151023000.	2.094	2.464,00	3.450,30

LINGO SHELVING SYSTEM

DOUBLE-SIDED - WOODEN BACK PANEL - ADJUSTABLE FEET - WITH OVERLAYING WOODEN TOP PLATE

Painted and veneered Lingo Shelving Systems are FSC-certified. Configurations with more than 2/3 bays are available.

H920 mm

Module mm	Shelf depth mm	No. of bays	Item no.	Melamine EUR	Painted EUR	Veneer EUR
500	250	1	BBN00234551013000.	777	913,90	1.279,50
500	250	2	BBN00234551023000.	1.282	1.508,80	2.112,80
500	250	3	BBN00234551033000.	1.805	2.123,50	2.974,30
500	300	1	BBN00236551013000.	944	1.111,00	1.555,80
500	300	2	BBN00236551023000.	1.539	1.811,00	2.536,20
500	300	3	BBN00236551033000.	2.152	2.532,80	3.547,40
500	400	1	BBN00238551013000.	1.245	1.464,50	2.050,90
500	400	2	BBN00238551023000.	1.996	2.348,00	3.287,60
500	400	3	BBN00238551033000.	2.767	3.255,20	4.558,30
750	250	1	BBN00234751013000.	927	1.091,10	1.527,00
750	250	2	BBN00234751023000.	1.567	1.843,30	2.580,80
750	250	3	BBN00234751033000.	2.231	2.624,70	3.675,20
750	300	1	BBN00236751013000.	1.104	1.298,70	1.818,30
750	300	2	BBN00236751023000.	1.840	2.164,50	3.030,80
750	300	3	BBN00236751033000.	2.604	3.063,30	4.289,50
750	400	1	BBN00238751013000.	1.414	1.663,00	2.328,40
750	400	2	BBN00238751023000.	2.313	2.720,80	3.809,40
750	400	3	BBN00238751033000.	3.244	3.814,80	5.340,60
900	250	1	BBN00234951013000.	978	1.151,50	1.611,40
900	250	2	BBN00234951023000.	1.669	1.964,10	2.749,60
900	300	1	BBN00236951013000.	1.155	1.359,10	1.902,70
900	300	2	BBN00236951023000.	1.942	2.285,30	3.199,60
900	400	1	BBN00238951013000.	1.465	1.723,40	2.412,80
900	400	2	BBN00238951023000.	2.416	2.841,60	3.978,20
1000	250	1	BBN00234151013000.	1.023	1.203,20	1.683,80
1000	250	2	BBN00234151023000.	1.752	2.061,40	2.884,90
1000	300	1	BBN00236151013000.	1.202	1.414,80	1.979,80
1000	300	2	BBN00236151023000.	2.031	2.389,40	3.344,10
1000	400	1	BBN00238151013000.	1.516	1.782,40	2.494,70
1000	400	2	BBN00238151023000.	2.510	2.951,80	4.131,90

LINGO SHELVING SYSTEM

DOUBLE-SIDED - WOODEN BACK PANEL - ADJUSTABLE FEET - WITH OVERLAYING WOODEN TOP PLATE

Painted and veneered Lingo Shelving Systems are FSC-certified. Configurations with more than 2/3 bays are available.

H1220 mm

Module mm	Shelf depth mm	No. of bays	Item no.	Melamine EUR	Painted EUR	Veneer EUR
500	250	1	BBN00244551013000.	975	1.146,80	1.605,90
500	250	2	BBN00244551023000.	1.602	1.885,10	2.640,00
500	250	3	BBN00244551033000.	2.246	2.643,20	3.702,30
500	300	1	BBN00246551013000.	1.177	1.384,70	1.939,60
500	300	2	BBN00246551023000.	1.911	2.248,50	3.149,50
500	300	3	BBN00246551033000.	2.664	3.134,10	4.390,20
500	400	1	BBN00248551013000.	1.563	1.839,40	2.576,30
500	400	2	BBN00248551023000.	2.496	2.937,30	4.113,30
500	400	3	BBN00248551033000.	3.449	4.058,90	5.684,30
750	250	1	BBN00244751013000.	1.148	1.351,20	1.891,30
750	250	2	BBN00244751023000.	1.933	2.274,00	3.183,80
750	250	3	BBN00244751033000.	2.742	3.226,00	4.516,90
750	300	1	BBN00246751013000.	1.360	1.599,60	2.240,00
750	300	2	BBN00246751023000.	2.258	2.656,40	3.719,90
750	300	3	BBN00246751033000.	3.185	3.746,20	5.246,00
750	400	1	BBN00248751013000.	1.756	2.065,10	2.891,70
750	400	2	BBN00248751023000.	2.860	3.364,50	4.710,90
750	400	3	BBN00248751033000.	3.995	4.700,10	6.580,30
900	250	1	BBN00244951013000.	1.205	1.417,70	1.985,10
900	250	2	BBN00244951023000.	2.046	2.407,00	3.371,40
900	300	1	BBN00246951013000.	1.417	1.666,10	2.333,80
900	300	2	BBN00246951023000.	2.371	2.789,40	3.907,50
900	400	1	BBN00248951013000.	1.812	2.131,60	2.985,50
900	400	2	BBN00248951023000.	2.973	3.497,50	4.898,50
1000	250	1	BBN00244151013000.	1.266	1.489,70	2.085,70
1000	250	2	BBN00244151023000.	2.163	2.544,90	3.563,10
1000	300	1	BBN00246151013000.	1.481	1.742,10	2.439,10
1000	300	2	BBN00246151023000.	2.494	2.934,10	4.108,40
1000	400	1	BBN00248151013000.	1.879	2.210,90	3.095,60
1000	400	2	BBN00248151023000.	3.101	3.648,30	5.108,60

LINGO SHELVING SYSTEM

DOUBLE-SIDED - WOODEN BACK PANEL - ADJUSTABLE FEET - WITH OVERLAYING WOODEN TOP PLATE

Painted and veneered Lingo Shelving Systems are FSC-certified. Configurations with more than 2/3 bays are available.

H1520 mm

Module mm	Shelf depth mm	No. of bays	Item no.	Melamine EUR	Painted EUR	Veneer EUR
500	250	1	BBN00254551013000.	1.089	1.280,70	1.792,30
500	250	2	BBN00254551023000.	1.794	2.109,90	2.953,20
500	250	3	BBN00254551033000.	2.516	2.958,90	4.142,30
500	300	1	BBN00256551013000.	1.261	1.483,80	2.078,40
500	300	2	BBN00256551023000.	2.058	2.421,10	3.391,30
500	300	3	BBN00256551033000.	2.874	3.380,20	4.735,00
500	400	1	BBN00258551013000.	1.667	1.960,70	2.745,50
500	400	2	BBN00258551023000.	2.671	3.143,20	4.400,70
500	400	3	BBN00258551033000.	3.697	4.349,40	6.089,90
750	250	1	BBN00254751013000.	1.283	1.509,10	2.111,30
750	250	2	BBN00254751023000.	2.165	2.546,80	3.564,20
750	250	3	BBN00254751033000.	3.072	3.613,70	5.057,70
750	300	1	BBN00256751013000.	1.465	1.722,70	2.412,40
750	300	2	BBN00256751023000.	2.445	2.877,00	4.028,90
750	300	3	BBN00256751033000.	3.455	4.064,30	5.691,60
750	400	1	BBN00258751013000.	1.879	2.210,40	3.094,50
750	400	2	BBN00258751023000.	3.075	3.618,40	5.065,50
750	400	3	BBN00258751033000.	4.302	5.062,60	7.086,70
900	250	1	BBN00254951013000.	1.357	1.596,70	2.234,60
900	250	2	BBN00254951023000.	2.314	2.722,00	3.810,80
900	300	1	BBN00256951013000.	1.539	1.810,30	2.535,70
900	300	2	BBN00256951023000.	2.594	3.052,20	4.275,50
900	400	1	BBN00258951013000.	1.953	2.298,00	3.217,80
900	400	2	BBN00258951023000.	3.224	3.793,60	5.312,10
1000	250	1	BBN00254151013000.	1.422	1.673,00	2.340,70
1000	250	2	BBN00254151023000.	2.438	2.868,50	4.013,50
1000	300	1	BBN00256151013000.	1.607	1.890,60	2.646,50
1000	300	2	BBN00256151023000.	2.724	3.205,50	4.487,40
1000	400	1	BBN00258151013000.	2.024	2.381,60	3.333,40
1000	400	2	BBN00258151023000.	3.359	3.953,00	5.533,20

LINGO SHELVING SYSTEM

DOUBLE-SIDED - WOODEN BACK PANEL - ADJUSTABLE FEET - WITH OVERLAYING WOODEN TOP PLATE

Painted and veneered Lingo Shelving Systems are FSC-certified. Configurations with more than 2/3 bays are available.

H1820 mm

Module mm	Shelf depth mm	No. of bays	Item no.	Melamine EUR	Painted EUR	Veneer EUR
500	250	1	BBN00264551013000.	1.250	1.471,30	2.059,80
500	250	2	BBN00264551023000.	2.054	2.416,90	3.383,60
500	250	3	BBN00264551033000.	2.874	3.382,30	4.735,60
500	300	1	BBN00266551013000.	1.452	1.709,20	2.391,90
500	300	2	BBN00266551023000.	2.362	2.780,30	3.890,70
500	300	3	BBN00266551033000.	3.291	3.873,20	5.420,30
500	400	1	BBN00268551013000.	1.930	2.270,90	3.179,80
500	400	2	BBN00268551023000.	3.085	3.629,60	5.081,30
500	400	3	BBN00268551033000.	4.260	5.012,00	7.016,80
750	250	1	BBN00264751013000.	1.462	1.720,10	2.408,60
750	250	2	BBN00264751023000.	2.460	2.894,60	4.054,20
750	250	3	BBN00264751033000.	3.483	4.098,30	5.740,40
750	300	1	BBN00266751013000.	1.673	1.968,50	2.755,70
750	300	2	BBN00266751023000.	2.785	3.277,00	4.587,90
750	300	3	BBN00266751033000.	3.925	4.618,50	6.466,30
750	400	1	BBN00268751013000.	2.160	2.541,00	3.558,60
750	400	2	BBN00268751023000.	3.523	4.145,60	5.805,70
750	400	3	BBN00268751033000.	4.918	5.786,40	8.103,00
900	250	1	BBN00264951013000.	1.556	1.831,20	2.563,20
900	250	2	BBN00264951023000.	2.648	3.116,80	4.363,40
900	300	1	BBN00266951013000.	1.767	2.079,60	2.910,30
900	300	2	BBN00266951023000.	2.973	3.499,20	4.897,10
900	400	1	BBN00268951013000.	2.254	2.652,10	3.713,20
900	400	2	BBN00268951023000.	3.712	4.367,80	6.114,90
1000	250	1	BBN00264151013000.	1.618	1.904,10	2.666,50
1000	250	2	BBN00264151023000.	2.768	3.256,50	4.560,50
1000	300	1	BBN00266151013000.	1.833	2.156,50	3.018,30
1000	300	2	BBN00266151023000.	3.098	3.645,70	5.103,40
1000	400	1	BBN00268151013000.	2.322	2.732,30	3.826,00
1000	400	2	BBN00268151023000.	3.842	4.520,40	6.330,40

LINGO SHELVING SYSTEM

DOUBLE-SIDED - WOODEN BACK PANEL - ADJUSTABLE FEET - WITH OVERLAYING WOODEN TOP PLATE

Painted and veneered Lingo Shelving Systems are FSC-certified. Configurations with more than 2/3 bays are available.

H2120 mm

Module mm	Shelf depth mm	No. of bays	Item no.	Melamine EUR	Painted EUR	Veneer EUR
500	250	1	BBN00274551013000.	1.398	1.644,00	2.302,40
500	250	2	BBN00274551023000.	2.296	2.699,50	3.780,90
500	250	3	BBN00274551033000.	3.210	3.774,80	5.287,60
500	300	1	BBN00276551013000.	1.643	1.932,50	2.705,70
500	300	2	BBN00276551023000.	2.668	3.138,80	4.394,80
500	300	3	BBN00276551033000.	3.712	4.366,90	6.114,70
500	400	1	BBN00278551013000.	2.190	2.574,80	3.605,80
500	400	2	BBN00278551023000.	3.494	4.109,00	5.753,70
500	400	3	BBN00278551033000.	4.819	5.666,90	7.935,60
750	250	1	BBN00274751013000.	1.629	1.917,00	2.683,30
750	250	2	BBN00274751023000.	2.742	3.225,60	4.515,70
750	250	3	BBN00274751033000.	3.879	4.563,40	6.388,70
750	300	1	BBN00276751013000.	1.883	2.216,00	3.101,60
750	300	2	BBN00276751023000.	3.131	3.683,90	5.156,20
750	300	3	BBN00276751033000.	4.406	5.184,80	7.257,00
750	400	1	BBN00278751013000.	2.439	2.869,10	4.016,70
750	400	2	BBN00278751023000.	3.973	4.673,40	6.542,30
750	400	3	BBN00278751033000.	5.538	6.513,90	9.118,10
900	250	1	BBN00274951013000.	1.737	2.044,00	2.862,10
900	250	2	BBN00274951023000.	2.958	3.479,60	4.873,30
900	300	1	BBN00276951013000.	1.992	2.343,00	3.280,40
900	300	2	BBN00276951023000.	3.347	3.937,90	5.513,80
900	400	1	BBN00278951013000.	2.547	2.996,10	4.195,50
900	400	2	BBN00278951023000.	4.189	4.927,40	6.899,90
1000	250	1	BBN00274151013000.	1.806	2.124,40	2.974,80
1000	250	2	BBN00274151023000.	3.089	3.634,30	5.089,20
1000	300	1	BBN00276151013000.	2.063	2.427,40	3.397,80
1000	300	2	BBN00276151023000.	3.484	4.099,40	5.738,90
1000	400	1	BBN00278151013000.	2.622	3.083,80	4.317,70
1000	400	2	BBN00278151023000.	4.331	5.095,00	7.134,20

LINGO SHELVING SYSTEM

BBN002 - CROSS BRACE - ADJUSTABLE FEET - WITH OVERLAYING WOODEN TOP PLATE



LINGO SHELVING SYSTEM

BBN002 - CROSS BRACE - ADJUSTABLE FEET - WITH OVERLAYING WOODEN TOP PLATE

Shelving system with wooden panels, cross brace and overlaying top plate.
 Middle shelf must be screwed into panels for bays above H1220 mm.
 For configurations with more than 3 bays, please contact Customer Service.

- Prices based on steel price group 1 and wooden price group A (see Design Options pages 6-9).
- For shelves see page 144 & 166.
- For accessories see page 186.

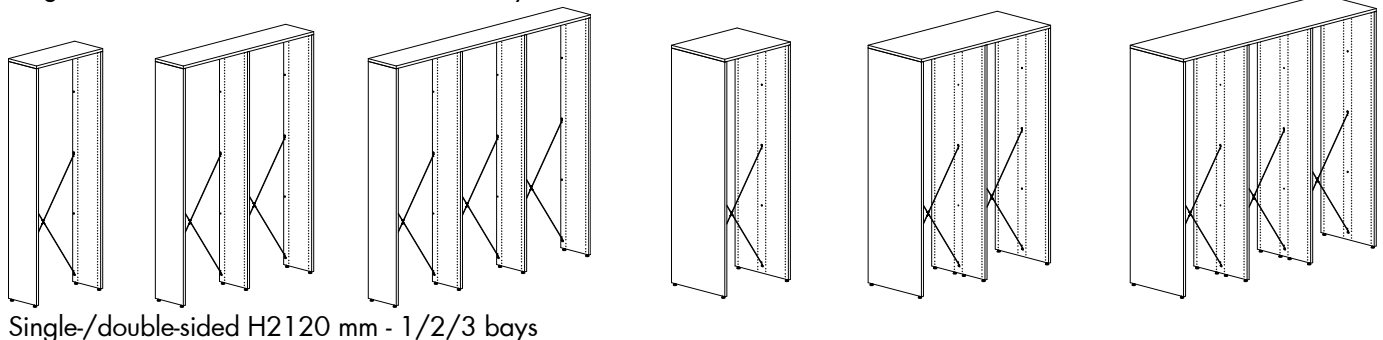
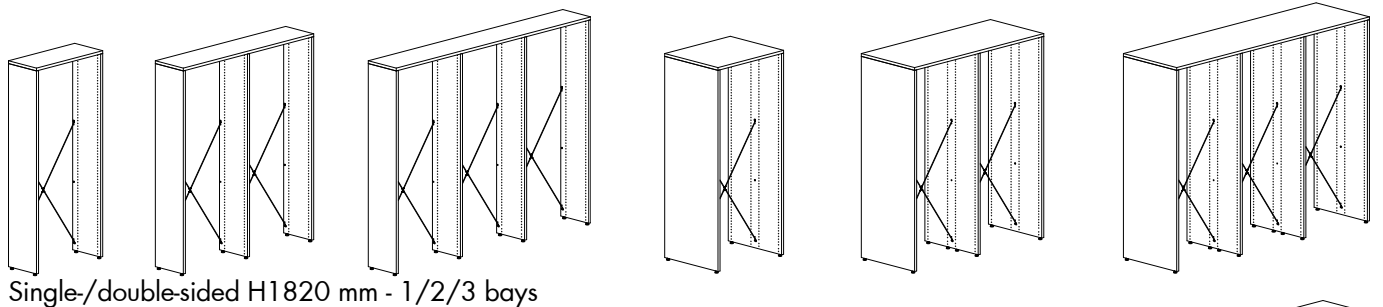
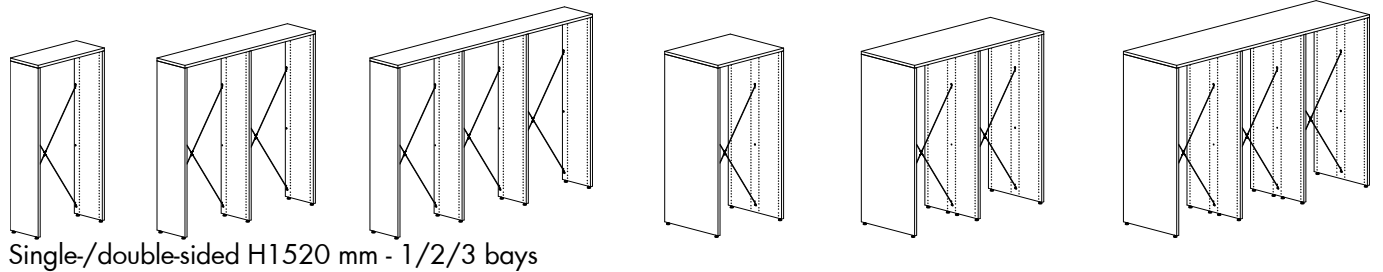
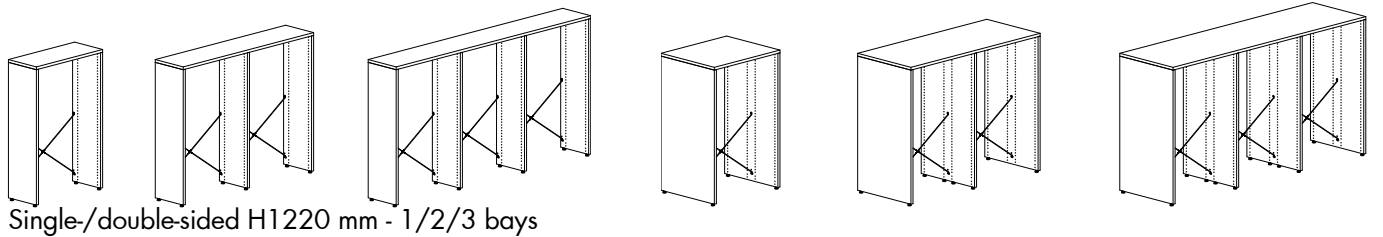
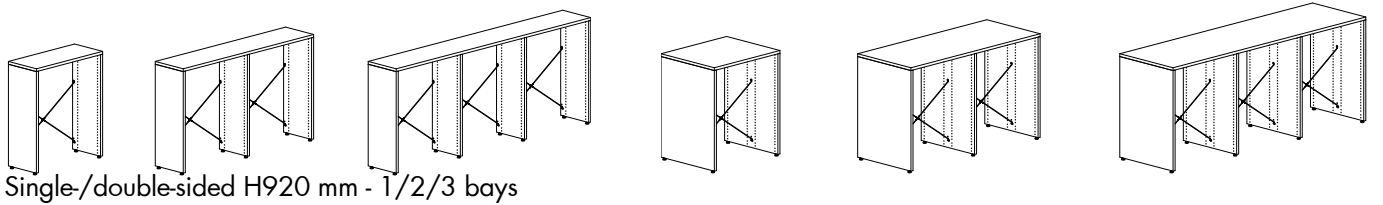
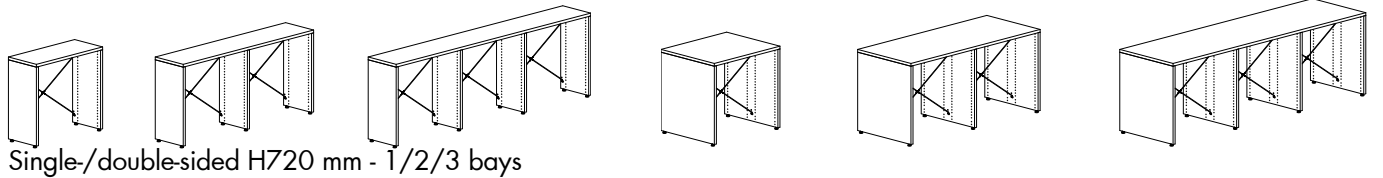

LINGO SHELVING SYSTEM

SINGLE-SIDED - CROSS BRACE - ADJUSTABLE FEET - WITH OVERLAYING WOODEN TOP PLATE

Painted and veneered Lingo Shelving Systems are FSC-certified. Configurations with more than 2/3 bays are available.

H720 mm

Module mm	Shelf depth mm	No. of bays	Item no.	Melamine EUR	Painted EUR	Veneer EUR
500	250	1	BBN00223551019000.	383	447,30	618,30
500	250	2	BBN00223551029000.	618	719,80	991,20
500	250	3	BBN00223551039000.	863	1.004,60	1.381,40
500	300	1	BBN00225551019000.	432	504,30	698,20
500	300	2	BBN00225551029000.	695	809,50	1.116,60
500	300	3	BBN00225551039000.	969	1.128,30	1.554,80
500	400	1	BBN00227551019000.	548	640,80	888,90
500	400	2	BBN00227551029000.	872	1.018,00	1.407,80
500	400	3	BBN00227551039000.	1.209	1.410,70	1.949,00
750	250	1	BBN00223751019000.	437	510,20	706,00
750	250	2	BBN00223751029000.	714	832,50	1.148,50
750	250	3	BBN00223751039000.	1.007	1.173,50	1.617,90
750	300	1	BBN00225751019000.	492	574,30	796,10
750	300	2	BBN00225751029000.	801	934,40	1.292,30
750	300	3	BBN00225751039000.	1.129	1.316,10	1.818,40
750	400	1	BBN00227751019000.	613	717,60	996,00
750	400	2	BBN00227751029000.	989	1.156,00	1.600,90
750	400	3	BBN00227751039000.	1.384	1.617,80	2.239,10
900	250	1	BBN00223951019000.	437	510,20	706,00
900	250	2	BBN00223951029000.	714	832,50	1.148,50
900	300	1	BBN00225951019000.	492	574,30	796,10
900	300	2	BBN00225951029000.	801	934,40	1.292,30
900	400	1	BBN00227951019000.	613	717,60	996,00
900	400	2	BBN00227951029000.	989	1.156,00	1.600,90
1000	250	1	BBN00223151019000.	454	531,30	735,50
1000	250	2	BBN00223151029000.	745	869,90	1.201,40
1000	300	1	BBN00225151019000.	512	597,50	828,50
1000	300	2	BBN00225151029000.	837	976,40	1.351,10
1000	400	1	BBN00227151019000.	635	743,00	1.032,00
1000	400	2	BBN00227151029000.	1.028	1.202,30	1.665,20

LINGO SHELVING SYSTEM

SINGLE-SIDED - CROSS BRACE - ADJUSTABLE FEET - WITH OVERLAYING WOODEN TOP PLATE

Painted and veneered Lingo Shelving Systems are FSC-certified. Configurations with more than 2/3 bays are available.

H920 mm

Module mm	Shelf depth mm	No. of bays	Item no.	Melamine EUR	Painted EUR	Veneer EUR
500	250	1	BBN00233551019000.	455	531,30	734,50
500	250	2	BBN00233551029000.	725	845,80	1.165,50
500	250	3	BBN00233551039000.	1.006	1.172,60	1.613,80
500	300	1	BBN00235551019000.	514	600,30	832,40
500	300	2	BBN00235551029000.	817	953,50	1.317,90
500	300	3	BBN00235551039000.	1.133	1.320,30	1.823,20
500	400	1	BBN00237551019000.	659	769,80	1.069,90
500	400	2	BBN00237551029000.	1.037	1.211,50	1.679,30
500	400	3	BBN00237551039000.	1.429	1.668,70	2.311,00
750	250	1	BBN00233751019000.	508	594,20	822,20
750	250	2	BBN00233751029000.	821	958,50	1.322,80
750	250	3	BBN00233751039000.	1.150	1.341,50	1.850,30
750	300	1	BBN00235751019000.	573	670,30	930,30
750	300	2	BBN00235751029000.	924	1.078,40	1.493,60
750	300	3	BBN00235751039000.	1.292	1.508,10	2.086,80
750	400	1	BBN00237751019000.	723	846,60	1.177,00
750	400	2	BBN00237751029000.	1.154	1.349,50	1.872,40
750	400	3	BBN00237751039000.	1.605	1.875,80	2.601,10
900	250	1	BBN00233951019000.	508	594,20	822,20
900	250	2	BBN00233951029000.	821	958,50	1.322,80
900	300	1	BBN00235951019000.	573	670,30	930,30
900	300	2	BBN00235951029000.	924	1.078,40	1.493,60
900	400	1	BBN00237951019000.	723	846,60	1.177,00
900	400	2	BBN00237951029000.	1.154	1.349,50	1.872,40
1000	250	1	BBN00233151019000.	526	615,30	851,70
1000	250	2	BBN00233151029000.	853	995,90	1.375,70
1000	300	1	BBN00235151019000.	593	693,50	962,70
1000	300	2	BBN00235151029000.	959	1.120,40	1.552,40
1000	400	1	BBN00237151019000.	745	872,00	1.213,00
1000	400	2	BBN00237151029000.	1.194	1.395,80	1.936,70

LINGO SHELVING SYSTEM

SINGLE-SIDED - CROSS BRACE - ADJUSTABLE FEET - WITH OVERLAYING WOODEN TOP PLATE

Painted and veneered Lingo Shelving Systems are FSC-certified. Configurations with more than 2/3 bays are available.

H1220 mm

Module mm	Shelf depth mm	No. of bays	Item no.	Melamine EUR	Painted EUR	Veneer EUR
500	250	1	BBN00243551019000.	561	655,10	909,50
500	250	2	BBN00243551029000.	884	1.031,50	1.428,00
500	250	3	BBN00243551039000.	1.218	1.420,20	1.963,80
500	300	1	BBN00245551019000.	591	691,50	959,00
500	300	2	BBN00245551029000.	933	1.090,30	1.507,80
500	300	3	BBN00245551039000.	1.287	1.502,70	2.076,40
500	400	1	BBN00247551019000.	807	944,80	1.314,10
500	400	2	BBN00247551029000.	1.259	1.474,00	2.045,60
500	400	3	BBN00247551039000.	1.726	2.018,70	2.799,40
750	250	1	BBN00243751019000.	614	718,00	997,20
750	250	2	BBN00243751029000.	980	1.144,20	1.585,30
750	250	3	BBN00243751039000.	1.361	1.589,10	2.200,30
750	300	1	BBN00245751019000.	651	761,50	1.056,90
750	300	2	BBN00245751029000.	1.040	1.215,20	1.683,50
750	300	3	BBN00245751039000.	1.447	1.690,50	2.340,00
750	400	1	BBN00247751019000.	872	1.021,60	1.421,20
750	400	2	BBN00247751029000.	1.377	1.612,00	2.238,70
750	400	3	BBN00247751039000.	1.901	2.225,80	3.089,50
900	250	1	BBN00243951019000.	614	718,00	997,20
900	250	2	BBN00243951029000.	980	1.144,20	1.585,30
900	300	1	BBN00245951019000.	651	761,50	1.056,90
900	300	2	BBN00245951029000.	1.040	1.215,20	1.683,50
900	400	1	BBN00247951019000.	872	1.021,60	1.421,20
900	400	2	BBN00247951029000.	1.377	1.612,00	2.238,70
1000	250	1	BBN00243151019000.	632	739,10	1.026,70
1000	250	2	BBN00243151029000.	1.011	1.181,60	1.638,20
1000	300	1	BBN00245151019000.	671	784,70	1.089,30
1000	300	2	BBN00245151029000.	1.076	1.257,20	1.742,30
1000	400	1	BBN00247151019000.	893	1.047,00	1.457,20
1000	400	2	BBN00247151029000.	1.416	1.658,30	2.303,00

LINGO SHELVING SYSTEM

SINGLE-SIDED - CROSS BRACE - ADJUSTABLE FEET - WITH OVERLAYING WOODEN TOP PLATE

Painted and veneered Lingo Shelving Systems are FSC-certified. Configurations with more than 2/3 bays are available.

H1520 mm

Module mm	Shelf depth mm	No. of bays	Item no.	Melamine EUR	Painted EUR	Veneer EUR
500	250	1	BBN00253551019000.	620	725,10	1.006,50
500	250	2	BBN00253551029000.	972	1.136,50	1.573,50
500	250	3	BBN00253551039000.	1.336	1.560,20	2.157,80
500	300	1	BBN00255551019000.	650	761,30	1.055,80
500	300	2	BBN00255551029000.	1.021	1.195,00	1.653,00
500	300	3	BBN00255551039000.	1.405	1.642,30	2.270,00
500	400	1	BBN00257551019000.	907	1.062,20	1.477,90
500	400	2	BBN00257551029000.	1.409	1.650,10	2.291,30
500	400	3	BBN00257551039000.	1.926	2.253,50	3.127,00
750	250	1	BBN00253751019000.	673	788,00	1.094,20
750	250	2	BBN00253751029000.	1.068	1.249,20	1.730,80
750	250	3	BBN00253751039000.	1.479	1.729,10	2.394,30
750	300	1	BBN00255751019000.	709	831,30	1.153,70
750	300	2	BBN00255751029000.	1.128	1.319,90	1.828,70
750	300	3	BBN00255751039000.	1.564	1.830,10	2.533,60
750	400	1	BBN00257751019000.	972	1.139,00	1.585,00
750	400	2	BBN00257751029000.	1.527	1.788,10	2.484,40
750	400	3	BBN00257751039000.	2.101	2.460,60	3.417,10
900	250	1	BBN00253951019000.	673	788,00	1.094,20
900	250	2	BBN00253951029000.	1.068	1.249,20	1.730,80
900	300	1	BBN00255951019000.	709	831,30	1.153,70
900	300	2	BBN00255951029000.	1.128	1.319,90	1.828,70
900	400	1	BBN00257951019000.	972	1.139,00	1.585,00
900	400	2	BBN00257951029000.	1.527	1.788,10	2.484,40
1000	250	1	BBN00253151019000.	691	809,10	1.123,70
1000	250	2	BBN00253151029000.	1.100	1.286,60	1.783,70
1000	300	1	BBN00255151019000.	729	854,50	1.186,10
1000	300	2	BBN00255151029000.	1.163	1.361,90	1.887,50
1000	400	1	BBN00257151019000.	993	1.164,40	1.621,00
1000	400	2	BBN00257151029000.	1.566	1.834,40	2.548,70

LINGO SHELVING SYSTEM

SINGLE-SIDED - CROSS BRACE - ADJUSTABLE FEET - WITH OVERLAYING WOODEN TOP PLATE

Painted and veneered Lingo Shelving Systems are FSC-certified. Configurations with more than 2/3 bays are available.

H1820 mm

Module mm	Shelf depth mm	No. of bays	Item no.	Melamine EUR	Painted EUR	Veneer EUR
500	250	1	BBN00263551019000.	705	824,70	1.146,30
500	250	2	BBN00263551029000.	1.100	1.285,90	1.783,20
500	250	3	BBN00263551039000.	1.505	1.759,40	2.437,40
500	300	1	BBN00265551019000.	729	854,70	1.186,80
500	300	2	BBN00265551029000.	1.141	1.335,10	1.849,50
500	300	3	BBN00265551039000.	1.564	1.829,10	2.532,00
500	400	1	BBN00267551019000.	1.015	1.190,00	1.658,50
500	400	2	BBN00267551029000.	1.572	1.841,80	2.562,20
500	400	3	BBN00267551039000.	2.143	2.509,10	3.488,20
750	250	1	BBN00263751019000.	758	887,60	1.234,00
750	250	2	BBN00263751029000.	1.195	1.398,60	1.940,50
750	250	3	BBN00263751039000.	1.649	1.928,30	2.673,90
750	300	1	BBN00265751019000.	789	924,70	1.284,70
750	300	2	BBN00265751029000.	1.247	1.460,00	2.025,20
750	300	3	BBN00265751039000.	1.724	2.016,90	2.795,60
750	400	1	BBN00267751019000.	1.080	1.266,80	1.765,60
750	400	2	BBN00267751029000.	1.690	1.979,80	2.755,30
750	400	3	BBN00267751039000.	2.318	2.716,20	3.778,30
900	250	1	BBN00263951019000.	758	887,60	1.234,00
900	250	2	BBN00263951029000.	1.195	1.398,60	1.940,50
900	300	1	BBN00265951019000.	789	924,70	1.284,70
900	300	2	BBN00265951029000.	1.247	1.460,00	2.025,20
900	400	1	BBN00267951019000.	1.080	1.266,80	1.765,60
900	400	2	BBN00267951029000.	1.690	1.979,80	2.755,30
1000	250	1	BBN00263151019000.	776	908,70	1.263,50
1000	250	2	BBN00263151029000.	1.227	1.436,00	1.993,40
1000	300	1	BBN00265151019000.	809	947,90	1.317,10
1000	300	2	BBN00265151029000.	1.283	1.502,00	2.084,00
1000	400	1	BBN00267151019000.	1.102	1.292,20	1.801,60
1000	400	2	BBN00267151029000.	1.729	2.026,10	2.819,60

LINGO SHELVING SYSTEM

SINGLE-SIDED - CROSS BRACE - ADJUSTABLE FEET - WITH OVERLAYING WOODEN TOP PLATE

Painted and veneered Lingo Shelving Systems are FSC-certified. Configurations with more than 2/3 bays are available.

H2120 mm

Module mm	Shelf depth mm	No. of bays	Item no.	Melamine EUR	Painted EUR	Veneer EUR
500	250	1	BBN00273551019000.	771	902,50	1.255,10
500	250	2	BBN00273551029000.	1.199	1.402,60	1.946,40
500	250	3	BBN00273551039000.	1.637	1.915,00	2.655,00
500	300	1	BBN00275551019000.	794	930,90	1.294,20
500	300	2	BBN00275551029000.	1.238	1.449,40	2.010,60
500	300	3	BBN00275551039000.	1.694	1.981,50	2.746,80
500	400	1	BBN00277551019000.	1.099	1.288,80	1.795,30
500	400	2	BBN00277551029000.	1.698	1.990,00	2.767,40
500	400	3	BBN00277551039000.	2.310	2.706,70	3.761,80
750	250	1	BBN00273751019000.	824	965,40	1.342,80
750	250	2	BBN00273751029000.	1.294	1.515,30	2.103,70
750	250	3	BBN00273751039000.	1.781	2.083,90	2.891,50
750	300	1	BBN00275751019000.	854	1.000,90	1.392,10
750	300	2	BBN00275751029000.	1.344	1.574,30	2.186,30
750	300	3	BBN00275751039000.	1.854	2.169,30	3.010,40
750	400	1	BBN00277751019000.	1.164	1.365,60	1.902,40
750	400	2	BBN00277751029000.	1.815	2.128,00	2.960,50
750	400	3	BBN00277751039000.	2.486	2.913,80	4.051,90
900	250	1	BBN00273951019000.	824	965,40	1.342,80
900	250	2	BBN00273951029000.	1.294	1.515,30	2.103,70
900	300	1	BBN00275951019000.	854	1.000,90	1.392,10
900	300	2	BBN00275951029000.	1.344	1.574,30	2.186,30
900	400	1	BBN00277951019000.	1.164	1.365,60	1.902,40
900	400	2	BBN00277951029000.	1.815	2.128,00	2.960,50
1000	250	1	BBN00273151019000.	842	986,50	1.372,30
1000	250	2	BBN00273151029000.	1.326	1.552,70	2.156,60
1000	300	1	BBN00275151019000.	874	1.024,10	1.424,50
1000	300	2	BBN00275151029000.	1.380	1.616,30	2.245,10
1000	400	1	BBN00277151019000.	1.186	1.391,00	1.938,40
1000	400	2	BBN00277151029000.	1.855	2.174,30	3.024,80

LINGO SHELVING SYSTEM

DOUBLE-SIDED - CROSS BRACE - ADJUSTABLE FEET - WITH OVERLAYING WOODEN TOP PLATE

Painted and veneered Lingo Shelving Systems are FSC-certified. Configurations with more than 2/3 bays are available.

H720 mm

Module mm	Shelf depth mm	No. of bays	Item no.	Melamine EUR	Painted EUR	Veneer EUR
500	250	1	BBN00224551019000.	559	653,30	905,40
500	250	2	BBN00224551029000.	898	1.048,40	1.449,80
500	250	3	BBN00224551039000.	1.254	1.463,30	2.022,40
500	300	1	BBN00226551019000.	693	811,40	1.127,70
500	300	2	BBN00226551029000.	1.105	1.292,10	1.792,20
500	300	3	BBN00226551039000.	1.536	1.794,60	2.487,50
500	400	1	BBN00228551019000.	933	1.093,50	1.522,80
500	400	2	BBN00228551029000.	1.470	1.722,00	2.393,60
500	400	3	BBN00228551039000.	2.028	2.374,20	3.298,40
750	250	1	BBN00224751019000.	641	750,20	1.040,70
750	250	2	BBN00224751029000.	1.046	1.222,30	1.693,40
750	250	3	BBN00224751039000.	1.475	1.723,60	2.386,70
750	300	1	BBN00226751019000.	785	918,80	1.278,00
750	300	2	BBN00226751029000.	1.269	1.485,00	2.062,40
750	300	3	BBN00226751039000.	1.782	2.084,20	2.893,00
750	400	1	BBN00228751019000.	1.034	1.211,70	1.688,10
750	400	2	BBN00228751029000.	1.651	1.934,20	2.691,00
750	400	3	BBN00228751039000.	2.299	2.692,90	3.744,10
900	250	1	BBN00224951019000.	641	750,20	1.040,70
900	250	2	BBN00224951029000.	1.046	1.222,30	1.693,40
900	300	1	BBN00226951019000.	785	918,80	1.278,00
900	300	2	BBN00226951029000.	1.269	1.485,00	2.062,40
900	400	1	BBN00228951019000.	1.034	1.211,70	1.688,10
900	400	2	BBN00228951029000.	1.651	1.934,20	2.691,00
1000	250	1	BBN00224151019000.	668	782,00	1.085,80
1000	250	2	BBN00224151029000.	1.095	1.279,80	1.774,10
1000	300	1	BBN00226151019000.	815	954,60	1.327,80
1000	300	2	BBN00226151029000.	1.324	1.549,30	2.152,30
1000	400	1	BBN00228151019000.	1.067	1.250,80	1.742,70
1000	400	2	BBN00228151029000.	1.711	2.004,60	2.790,10

LINGO SHELVING SYSTEM

DOUBLE-SIDED - CROSS BRACE - ADJUSTABLE FEET - WITH OVERLAYING WOODEN TOP PLATE

Painted and veneered Lingo Shelving Systems are FSC-certified. Configurations with more than 2/3 bays are available.

H920 mm

Module mm	Shelf depth mm	No. of bays	Item no.	Melamine EUR	Painted EUR	Veneer EUR
500	250	1	BBN00234551019000.	662	774,90	1.075,80
500	250	2	BBN00234551029000.	1.053	1.230,80	1.705,40
500	250	3	BBN00234551039000.	1.460	1.706,50	2.363,20
500	300	1	BBN00236551019000.	829	972,00	1.352,10
500	300	2	BBN00236551029000.	1.309	1.533,00	2.128,80
500	300	3	BBN00236551039000.	1.808	2.115,80	2.936,30
500	400	1	BBN00238551019000.	1.131	1.325,50	1.847,20
500	400	2	BBN00238551029000.	1.766	2.070,00	2.880,20
500	400	3	BBN00238551039000.	2.423	2.838,20	3.947,20
750	250	1	BBN00234751019000.	744	871,80	1.211,10
750	250	2	BBN00234751029000.	1.201	1.404,70	1.949,00
750	250	3	BBN00234751039000.	1.682	1.966,80	2.727,50
750	300	1	BBN00236751019000.	921	1.079,40	1.502,40
750	300	2	BBN00236751029000.	1.473	1.725,90	2.399,00
750	300	3	BBN00236751039000.	2.054	2.405,40	3.341,80
750	400	1	BBN00238751019000.	1.231	1.443,70	2.012,50
750	400	2	BBN00238751029000.	1.947	2.282,20	3.177,60
750	400	3	BBN00238751039000.	2.694	3.156,90	4.392,90
900	250	1	BBN00234951019000.	744	871,80	1.211,10
900	250	2	BBN00234951029000.	1.201	1.404,70	1.949,00
900	300	1	BBN00236951019000.	921	1.079,40	1.502,40
900	300	2	BBN00236951029000.	1.473	1.725,90	2.399,00
900	400	1	BBN00238951019000.	1.231	1.443,70	2.012,50
900	400	2	BBN00238951029000.	1.947	2.282,20	3.177,60
1000	250	1	BBN00234151019000.	772	903,60	1.256,20
1000	250	2	BBN00234151029000.	1.249	1.462,20	2.029,70
1000	300	1	BBN00236151019000.	951	1.115,20	1.552,20
1000	300	2	BBN00236151029000.	1.528	1.790,20	2.488,90
1000	400	1	BBN00238151019000.	1.264	1.482,80	2.067,10
1000	400	2	BBN00238151029000.	2.007	2.352,60	3.276,70

LINGO SHELVING SYSTEM

DOUBLE-SIDED - CROSS BRACE - ADJUSTABLE FEET - WITH OVERLAYING WOODEN TOP PLATE

Painted and veneered Lingo Shelving Systems are FSC-certified. Configurations with more than 2/3 bays are available.

H1220 mm

Module mm	Shelf depth mm	No. of bays	Item no.	Melamine EUR	Painted EUR	Veneer EUR
500	250	1	BBN00244551019000.	814	953,90	1.327,00
500	250	2	BBN00244551029000.	1.281	1.499,30	2.082,20
500	250	3	BBN00244551039000.	1.764	2.064,50	2.865,60
500	300	1	BBN00246551019000.	1.016	1.191,80	1.660,70
500	300	2	BBN00246551029000.	1.590	1.862,70	2.591,70
500	300	3	BBN00246551039000.	2.182	2.555,40	3.553,50
500	400	1	BBN00248551019000.	1.403	1.646,50	2.297,40
500	400	2	BBN00248551029000.	2.175	2.551,50	3.555,50
500	400	3	BBN00248551039000.	2.968	3.480,20	4.847,60
750	250	1	BBN00244751019000.	896	1.050,80	1.462,30
750	250	2	BBN00244751029000.	1.429	1.673,20	2.325,80
750	250	3	BBN00244751039000.	1.986	2.324,80	3.229,90
750	300	1	BBN00246751019000.	1.108	1.299,20	1.811,00
750	300	2	BBN00246751029000.	1.754	2.055,60	2.861,90
750	300	3	BBN00246751039000.	2.429	2.845,00	3.959,00
750	400	1	BBN00248751019000.	1.503	1.764,70	2.462,70
750	400	2	BBN00248751029000.	2.355	2.763,70	3.852,90
750	400	3	BBN00248751039000.	3.239	3.798,90	5.293,30
900	250	1	BBN00244951019000.	896	1.050,80	1.462,30
900	250	2	BBN00244951029000.	1.429	1.673,20	2.325,80
900	300	1	BBN00246951019000.	1.108	1.299,20	1.811,00
900	300	2	BBN00246951029000.	1.754	2.055,60	2.861,90
900	400	1	BBN00248951019000.	1.503	1.764,70	2.462,70
900	400	2	BBN00248951029000.	2.355	2.763,70	3.852,90
1000	250	1	BBN00244151019000.	924	1.082,60	1.507,40
1000	250	2	BBN00244151029000.	1.477	1.730,70	2.406,50
1000	300	1	BBN00246151019000.	1.138	1.335,00	1.860,80
1000	300	2	BBN00246151029000.	1.809	2.119,90	2.951,80
1000	400	1	BBN00248151019000.	1.537	1.803,80	2.517,30
1000	400	2	BBN00248151029000.	2.415	2.834,10	3.952,00

LINGO SHELVING SYSTEM

DOUBLE-SIDED - CROSS BRACE - ADJUSTABLE FEET - WITH OVERLAYING WOODEN TOP PLATE

Painted and veneered Lingo Shelving Systems are FSC-certified. Configurations with more than 2/3 bays are available.

H1520 mm

Module mm	Shelf depth mm	No. of bays	Item no.	Melamine EUR	Painted EUR	Veneer EUR
500	250	1	BBN00254551019000.	888	1.039,90	1.446,20
500	250	2	BBN00254551029000.	1.391	1.628,30	2.261,00
500	250	3	BBN00254551039000.	1.911	2.236,50	3.104,00
500	300	1	BBN00256551019000.	1.060	1.243,00	1.732,30
500	300	2	BBN00256551029000.	1.655	1.939,50	2.699,10
500	300	3	BBN00256551039000.	2.269	2.657,80	3.696,70
500	400	1	BBN00258551019000.	1.465	1.719,90	2.399,40
500	400	2	BBN00258551029000.	2.268	2.661,60	3.708,50
500	400	3	BBN00258551039000.	3.092	3.627,00	5.051,60
750	250	1	BBN00254751019000.	969	1.136,80	1.581,50
750	250	2	BBN00254751029000.	1.539	1.802,20	2.504,60
750	250	3	BBN00254751039000.	2.132	2.496,80	3.468,30
750	300	1	BBN00256751019000.	1.151	1.350,40	1.882,60
750	300	2	BBN00256751029000.	1.819	2.132,40	2.969,30
750	300	3	BBN00256751039000.	2.515	2.947,40	4.102,20
750	400	1	BBN00258751019000.	1.566	1.838,10	2.564,70
750	400	2	BBN00258751029000.	2.449	2.873,80	4.005,90
750	400	3	BBN00258751039000.	3.363	3.945,70	5.497,30
900	250	1	BBN00254951019000.	969	1.136,80	1.581,50
900	250	2	BBN00254951029000.	1.539	1.802,20	2.504,60
900	300	1	BBN00256951019000.	1.151	1.350,40	1.882,60
900	300	2	BBN00256951029000.	1.819	2.132,40	2.969,30
900	400	1	BBN00258951019000.	1.566	1.838,10	2.564,70
900	400	2	BBN00258951029000.	2.449	2.873,80	4.005,90
1000	250	1	BBN00254151019000.	997	1.168,60	1.626,60
1000	250	2	BBN00254151029000.	1.588	1.859,70	2.585,30
1000	300	1	BBN00256151019000.	1.182	1.386,20	1.932,40
1000	300	2	BBN00256151029000.	1.874	2.196,70	3.059,20
1000	400	1	BBN00258151019000.	1.599	1.877,20	2.619,30
1000	400	2	BBN00258151029000.	2.509	2.944,20	4.105,00

LINGO SHELVING SYSTEM

DOUBLE-SIDED - CROSS BRACE - ADJUSTABLE FEET - WITH OVERLAYING WOODEN TOP PLATE

Painted and veneered Lingo Shelving Systems are FSC-certified. Configurations with more than 2/3 bays are available.

H1820 mm

Module mm	Shelf depth mm	No. of bays	Item no.	Melamine EUR	Painted EUR	Veneer EUR
500	250	1	BBN00264551019000.	1.013	1.188,30	1.655,40
500	250	2	BBN00264551029000.	1.579	1.850,90	2.574,80
500	250	3	BBN00264551039000.	2.162	2.533,30	3.522,40
500	300	1	BBN00266551019000.	1.215	1.426,20	1.987,50
500	300	2	BBN00266551029000.	1.888	2.214,30	3.081,90
500	300	3	BBN00266551039000.	2.579	3.024,20	4.207,10
500	400	1	BBN00268551019000.	1.693	1.987,90	2.775,40
500	400	2	BBN00268551029000.	2.610	3.063,60	4.272,50
500	400	3	BBN00268551039000.	3.548	4.163,00	5.803,60
750	250	1	BBN00264751019000.	1.095	1.285,20	1.790,70
750	250	2	BBN00264751029000.	1.727	2.024,80	2.818,40
750	250	3	BBN00264751039000.	2.384	2.793,60	3.886,70
750	300	1	BBN00266751019000.	1.307	1.533,60	2.137,80
750	300	2	BBN00266751029000.	2.052	2.407,20	3.352,10
750	300	3	BBN00266751039000.	2.826	3.313,80	4.612,60
750	400	1	BBN00268751019000.	1.793	2.106,10	2.940,70
750	400	2	BBN00268751029000.	2.790	3.275,80	4.569,90
750	400	3	BBN00268751039000.	3.819	4.481,70	6.249,30
900	250	1	BBN00264951019000.	1.095	1.285,20	1.790,70
900	250	2	BBN00264951029000.	1.727	2.024,80	2.818,40
900	300	1	BBN00266951019000.	1.307	1.533,60	2.137,80
900	300	2	BBN00266951029000.	2.052	2.407,20	3.352,10
900	400	1	BBN00268951019000.	1.793	2.106,10	2.940,70
900	400	2	BBN00268951029000.	2.790	3.275,80	4.569,90
1000	250	1	BBN00264151019000.	1.123	1.317,00	1.835,80
1000	250	2	BBN00264151029000.	1.776	2.082,30	2.899,10
1000	300	1	BBN00266151019000.	1.337	1.569,40	2.187,60
1000	300	2	BBN00266151029000.	2.107	2.471,50	3.442,00
1000	400	1	BBN00268151019000.	1.827	2.145,20	2.995,30
1000	400	2	BBN00268151029000.	2.850	3.346,20	4.669,00

LINGO SHELVING SYSTEM

DOUBLE-SIDED - CROSS BRACE - ADJUSTABLE FEET - WITH OVERLAYING WOODEN TOP PLATE

Painted and veneered Lingo Shelving Systems are FSC-certified. Configurations with more than 2/3 bays are available.

H2120 mm

Module mm	Shelf depth mm	No. of bays	Item no.	Melamine EUR	Painted EUR	Veneer EUR
500	250	1	BBN00274551019000.	1.121	1.313,90	1.831,20
500	250	2	BBN00274551029000.	1.740	2.039,30	2.838,50
500	250	3	BBN00274551039000.	2.377	2.784,50	3.874,00
500	300	1	BBN00276551019000.	1.365	1.602,40	2.234,50
500	300	2	BBN00276551029000.	2.113	2.478,60	3.452,40
500	300	3	BBN00276551039000.	2.879	3.376,60	4.701,10
500	400	1	BBN00278551019000.	1.912	2.244,70	3.134,60
500	400	2	BBN00278551029000.	2.939	3.448,80	4.811,30
500	400	3	BBN00278551039000.	3.986	4.676,60	6.522,00
750	250	1	BBN00274751019000.	1.202	1.410,80	1.966,50
750	250	2	BBN00274751029000.	1.888	2.213,20	3.082,10
750	250	3	BBN00274751039000.	2.598	3.044,80	4.238,30
750	300	1	BBN00276751019000.	1.457	1.709,80	2.384,80
750	300	2	BBN00276751029000.	2.277	2.671,50	3.722,60
750	300	3	BBN00276751039000.	3.126	3.666,20	5.106,60
750	400	1	BBN00278751019000.	2.013	2.362,90	3.299,90
750	400	2	BBN00278751029000.	3.119	3.661,00	5.108,70
750	400	3	BBN00278751039000.	4.257	4.995,30	6.967,70
900	250	1	BBN00274951019000.	1.202	1.410,80	1.966,50
900	250	2	BBN00274951029000.	1.888	2.213,20	3.082,10
900	300	1	BBN00276951019000.	1.457	1.709,80	2.384,80
900	300	2	BBN00276951029000.	2.277	2.671,50	3.722,60
900	400	1	BBN00278951019000.	2.013	2.362,90	3.299,90
900	400	2	BBN00278951029000.	3.119	3.661,00	5.108,70
1000	250	1	BBN00274151019000.	1.230	1.442,60	2.011,60
1000	250	2	BBN00274151029000.	1.937	2.270,70	3.162,80
1000	300	1	BBN00276151019000.	1.487	1.745,60	2.434,60
1000	300	2	BBN00276151029000.	2.332	2.735,80	3.812,50
1000	400	1	BBN00278151019000.	2.046	2.402,00	3.354,50
1000	400	2	BBN00278151029000.	3.179	3.731,40	5.207,80

LINGO SHELVING SYSTEM

BBN011 - STEEL BACK FRAME - CASTOR PLATE - FOR TOP SHELF



LINGO SHELVING SYSTEM

BBN011 - STEEL BACK FRAME - CASTOR PLATE - FOR TOP SHELF

Shelving system with wooden panels, metal back frame and castor plate.
To be used with top shelf.

- Prices based on steel price group 1 and wooden price group A (see Design Options pages 6-9).
- For top shelves, see pages 156 & 174
- For shelves see page 144 & 166.
- For accessories see page 186.

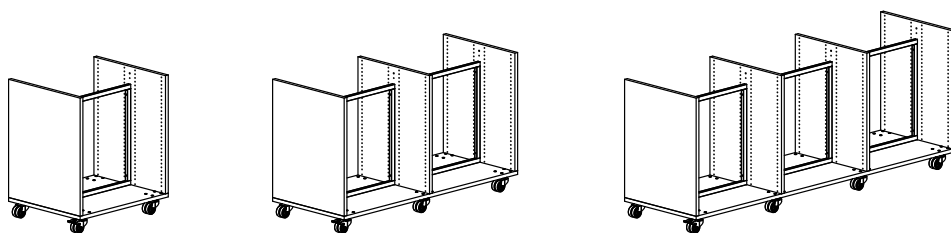

Double-sided H920 mm - 1/2/3 bays

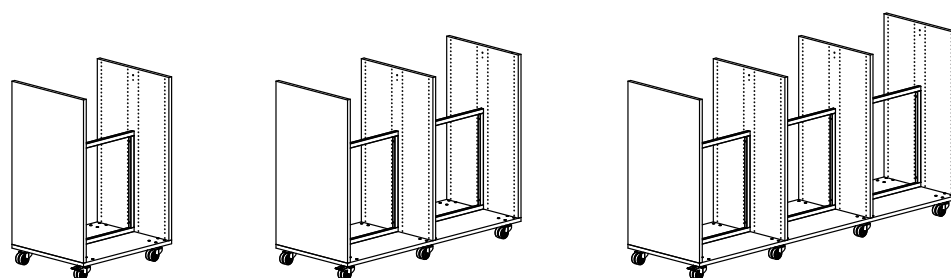

Double-sided H1220 mm - 1/2/3 bays

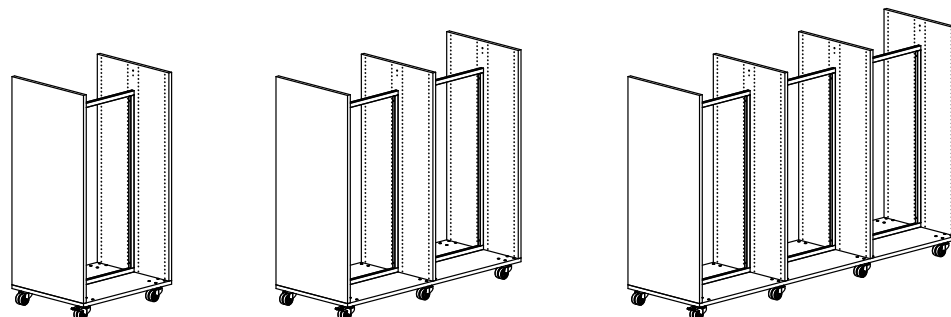

Double-sided H1520 mm - 1/2/3 bays

LINGO SHELVING SYSTEM

DOUBLE-SIDED - STEEL BACK FRAME - CASTOR PLATE - FOR TOP SHELF

Painted and veneered Lingo Shelving Systems are FSC-certified.

H920 mm

Module mm	Shelf depth mm	No. of bays	Item no.	Melamine EUR	Painted EUR	Veneer EUR
500	250	1	BBN011345016000.	822,20	953,30	1.303,50
500	250	2	BBN011345026000.	1.272,00	1.468,90	1.994,20
500	250	3	BBN011345036000.	1.789,30	2.063,40	2.794,40
500	300	1	BBN011365016000.	1.000,70	1.163,70	1.598,60
500	300	2	BBN011365026000.	1.540,50	1.785,30	2.436,80
500	300	3	BBN011365036000.	2.154,70	2.493,80	3.397,40
500	400	1	BBN011385016000.	1.313,80	1.531,40	2.112,20
500	400	2	BBN011385026000.	2.009,60	2.336,00	3.207,60
500	400	3	BBN011385036000.	2.787,60	3.236,90	4.437,80
750	250	1	BBN011347016000.	955,70	1.110,60	1.523,90
750	250	2	BBN011347026000.	1.473,00	1.705,10	2.324,10
750	250	3	BBN011347036000.	2.090,40	2.417,70	3.290,30
750	300	1	BBN011367016000.	1.149,60	1.339,10	1.843,40
750	300	2	BBN011367026000.	1.763,80	2.047,60	2.804,00
750	300	3	BBN011367036000.	2.489,30	2.887,50	3.948,80
750	400	1	BBN011387016000.	1.477,20	1.723,70	2.381,70
750	400	2	BBN011387026000.	2.255,20	2.624,60	3.611,90
750	400	3	BBN011387036000.	3.155,30	3.670,10	5.043,90
900	250	1	BBN011349016000.	1.036,20	1.205,40	1.656,00
900	250	2	BBN011349026000.	1.593,40	1.846,80	2.523,00
900	300	1	BBN011369016000.	1.238,90	1.443,90	1.990,00
900	300	2	BBN011369026000.	1.897,50	2.205,10	3.024,60
900	400	1	BBN011389016000.	1.575,20	1.838,80	2.543,70
900	400	2	BBN011389026000.	2.402,30	2.797,90	3.854,20
1000	250	1	BBN011341016000.	1.100,20	1.278,60	1.754,30
1000	250	2	BBN011341026000.	1.694,70	1.962,40	2.676,30
1000	300	1	BBN011361016000.	1.309,00	1.524,50	2.098,20
1000	300	2	BBN011361026000.	2.007,40	2.331,00	3.192,50
1000	400	1	BBN011381016000.	1.651,00	1.926,30	2.661,60
1000	400	2	BBN011381026000.	2.521,40	2.934,40	4.036,60

LINGO SHELVING SYSTEM

DOUBLE-SIDED - STEEL BACK FRAME - CASTOR PLATE - FOR TOP SHELF

Painted and veneered Lingo Shelving Systems are FSC-certified.

H1220 mm

Module mm	Shelf depth mm	No. of bays	Item no.	Melamine EUR	Painted EUR	Veneer EUR
500	250	1	BBN011445016000.	974,20	1.132,30	1.554,70
500	250	2	BBN011445026000.	1.500,00	1.737,40	2.371,00
500	250	3	BBN011445036000.	2.093,30	2.421,40	3.296,80
500	300	1	BBN011465016000.	1.187,90	1.383,50	1.907,20
500	300	2	BBN011465026000.	1.821,30	2.115,00	2.899,70
500	300	3	BBN011465036000.	2.529,10	2.933,40	4.014,60
500	400	1	BBN011485016000.	1.586,20	1.852,40	2.562,40
500	400	2	BBN011485026000.	2.418,20	2.817,50	3.882,90
500	400	3	BBN011485036000.	3.332,40	3.878,90	5.338,20
750	250	1	BBN011447016000.	1.107,70	1.289,60	1.775,10
750	250	2	BBN011447026000.	1.701,00	1.973,60	2.700,90
750	250	3	BBN011447036000.	2.394,40	2.775,70	3.792,70
750	300	1	BBN011467016000.	1.336,80	1.558,90	2.152,00
750	300	2	BBN011467026000.	2.044,60	2.377,30	3.266,90
750	300	3	BBN011467036000.	2.863,70	3.327,10	4.566,00
750	400	1	BBN011487016000.	1.749,60	2.044,70	2.831,90
750	400	2	BBN011487026000.	2.663,80	3.106,10	4.287,20
750	400	3	BBN011487036000.	3.700,10	4.312,10	5.944,30
900	250	1	BBN011449016000.	1.188,20	1.384,40	1.907,20
900	250	2	BBN011449026000.	1.821,40	2.115,30	2.899,80
900	300	1	BBN011469016000.	1.426,10	1.663,70	2.298,60
900	300	2	BBN011469026000.	2.178,30	2.534,80	3.487,50
900	400	1	BBN011489016000.	1.847,60	2.159,80	2.993,90
900	400	2	BBN011489026000.	2.810,90	3.279,40	4.529,50
1000	250	1	BBN011441016000.	1.252,20	1.457,60	2.005,50
1000	250	2	BBN011441026000.	1.922,70	2.230,90	3.053,10
1000	300	1	BBN011461016000.	1.496,20	1.744,30	2.406,80
1000	300	2	BBN011461026000.	2.288,20	2.660,70	3.655,40
1000	400	1	BBN011481016000.	1.923,40	2.247,30	3.111,80
1000	400	2	BBN011481026000.	2.930,00	3.415,90	4.711,90

LINGO SHELVING SYSTEM

DOUBLE-SIDED - STEEL BACK FRAME - CASTOR PLATE - FOR TOP SHELF

Painted and veneered Lingo Shelving Systems are FSC-certified.

H1520 mm

Module mm	Shelf depth mm	No. of bays	Item no.	Melamine EUR	Painted EUR	Veneer EUR
500	250	1	BBN011545016000.	1.071,10	1.241,80	1.697,40
500	250	2	BBN011545026000.	1.657,10	1.913,40	2.596,80
500	250	3	BBN011545036000.	2.310,60	2.663,90	3.605,70
500	300	1	BBN011565016000.	1.254,80	1.458,20	2.002,30
500	300	2	BBN011565026000.	1.933,40	2.238,80	3.054,10
500	300	3	BBN011565036000.	2.686,40	3.106,30	4.228,30
500	400	1	BBN011585016000.	1.671,90	1.949,30	2.687,90
500	400	2	BBN011585026000.	2.558,50	2.974,60	4.082,90
500	400	3	BBN011585036000.	3.527,30	4.096,20	5.612,70
750	250	1	BBN011547016000.	1.204,60	1.399,10	1.917,80
750	250	2	BBN011547026000.	1.858,10	2.149,60	2.926,70
750	250	3	BBN011547036000.	2.611,70	3.018,20	4.101,60
750	300	1	BBN011567016000.	1.403,70	1.633,60	2.247,10
750	300	2	BBN011567026000.	2.156,70	2.501,10	3.421,30
750	300	3	BBN011567036000.	3.021,00	3.500,00	4.779,70
750	400	1	BBN011587016000.	1.835,30	2.141,60	2.957,40
750	400	2	BBN011587026000.	2.804,10	3.263,20	4.487,20
750	400	3	BBN011587036000.	3.895,00	4.529,40	6.218,80
900	250	1	BBN011549016000.	1.285,10	1.493,90	2.049,90
900	250	2	BBN011549026000.	1.978,50	2.291,30	3.125,60
900	300	1	BBN011569016000.	1.493,00	1.738,40	2.393,70
900	300	2	BBN011569026000.	2.290,40	2.658,60	3.641,90
900	400	1	BBN011589016000.	1.933,30	2.256,70	3.119,40
900	400	2	BBN011589026000.	2.951,20	3.436,50	4.729,50
1000	250	1	BBN011541016000.	1.351,90	1.569,90	2.151,00
1000	250	2	BBN011541026000.	2.085,40	2.412,50	3.284,50
1000	300	1	BBN011561016000.	1.565,90	1.821,80	2.504,70
1000	300	2	BBN011561026000.	2.405,90	2.790,10	3.815,40
1000	400	1	BBN011581016000.	2.011,90	2.347,00	3.240,10
1000	400	2	BBN011581026000.	3.075,90	3.578,60	4.917,50



LINGO SHELVING SYSTEM

BBN011 - HIGH WOODEN BACK PANEL - CASTOR PLATE - FOR TOP SHELF



LINGO SHELVING SYSTEM

BBN011 - HIGH WOODEN BACK PANEL - CASTOR PLATE - FOR TOP SHELF

Shelving system with wooden panels, wooden back panel and castor plate.
To be used with ST1 standard depth, ST1 double-sided, ST2, ST3 and WT1 standard depth top shelf.

- Prices based on steel price group 1 and wooden price group A (see Design Options pages 6-9).
- For top shelves, see pages 156 & 174
- For shelves see page 144 & 166.
- For accessories see page 186.

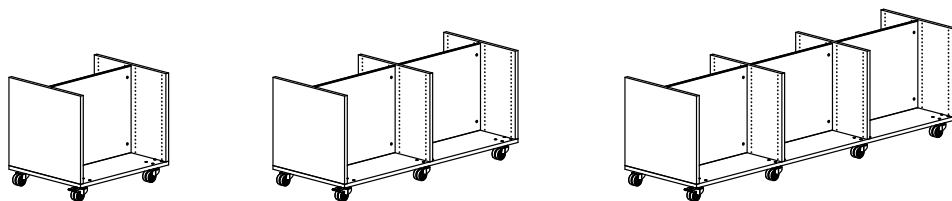

Double-sided H720 mm - 1/2/3 bays

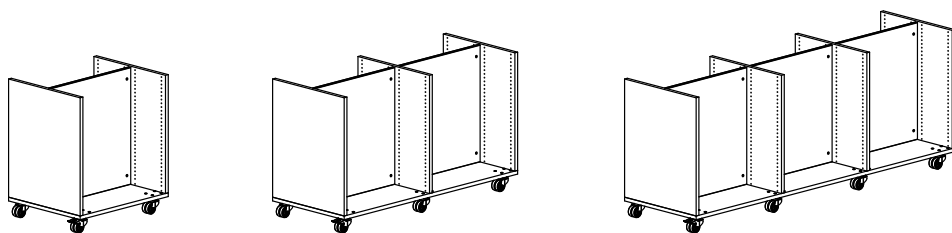

Double-sided H920 mm - 1/2/3 bays

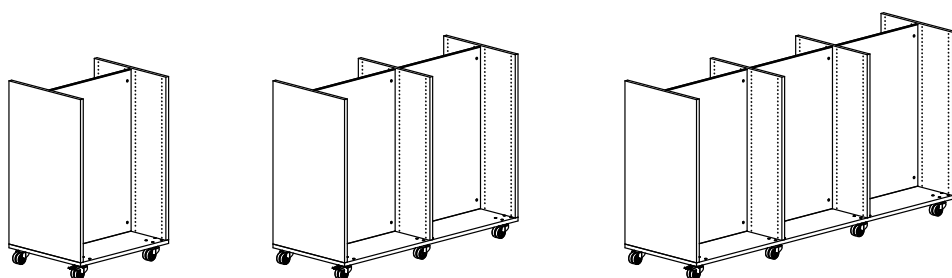

Double-sided H1220 mm - 1/2/3 bays

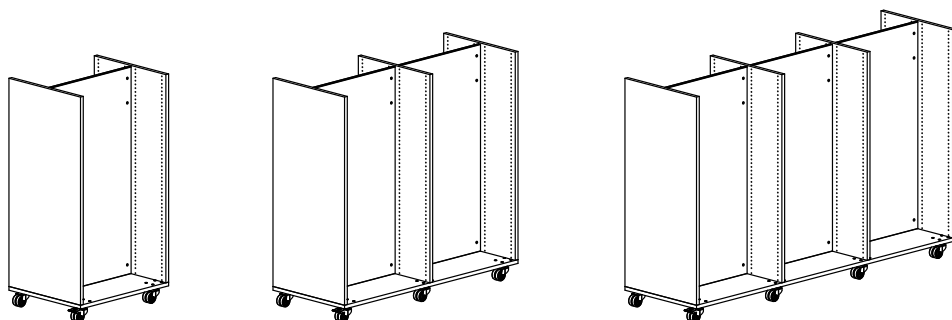

Double-sided H1520 mm - 1/2/3 bays

LINGO SHELVING SYSTEM

DOUBLE-SIDED - HIGH WOODEN BACK PANEL - CASTOR PLATE - FOR TOP SHELF

Painted and veneered Lingo Shelving Systems are FSC-certified.

H720 mm

Module mm	Shelf depth mm	No. of bays	Item no.	Melamine EUR	Painted EUR	Veneer EUR
500	250	1	BBN0112450120006	747,60	879,00	1.230,90
500	250	2	BBN0112450220006	1.174,40	1.381,10	1.934,20
500	250	3	BBN0112450320006	1.668,70	1.962,10	2.747,00
500	300	1	BBN0112650120006	893,30	1.050,40	1.472,00
500	300	2	BBN0112650220006	1.393,70	1.639,00	2.295,80
500	300	3	BBN0112650320006	1.968,50	2.314,50	3.242,00
500	400	1	BBN0112850120006	1.145,00	1.346,70	1.885,60
500	400	2	BBN0112850220006	1.770,70	2.082,60	2.916,60
500	400	3	BBN0112850320006	2.478,60	2.914,80	4.082,40
750	250	1	BBN0112470120006	934,40	1.099,30	1.539,80
750	250	2	BBN0112470220006	1.482,00	1.743,30	2.441,10
750	250	3	BBN0112470320006	2.129,70	2.505,40	3.508,40
750	300	1	BBN0112670120006	1.095,50	1.288,80	1.805,30
750	300	2	BBN0112670220006	1.723,60	2.027,30	2.840,00
750	300	3	BBN0112670320006	2.463,00	2.897,20	4.058,90
750	400	1	BBN0112870120006	1.361,70	1.602,00	2.243,60
750	400	2	BBN0112870220006	2.122,90	2.497,20	3.497,90
750	400	3	BBN0112870320006	3.006,20	3.537,00	4.954,00
900	250	1	BBN0112490120006	1.055,00	1.241,00	1.737,30
900	250	2	BBN0112490220006	1.682,60	1.978,80	2.770,80
900	300	1	BBN0112690120006	1.224,90	1.440,50	2.017,30
900	300	2	BBN0112690220006	1.937,50	2.278,60	3.191,40
900	400	1	BBN0112890120006	1.499,80	1.764,00	2.471,00
900	400	2	BBN0112890220006	2.350,20	2.764,30	3.871,00
1000	250	1	BBN0112410120006	1.121,80	1.319,70	1.847,00
1000	250	2	BBN0112410220006	1.789,50	2.105,40	2.946,90
1000	300	1	BBN0112610120006	1.297,80	1.526,60	2.136,90
1000	300	2	BBN0112610220006	2.053,00	2.415,50	3.382,10
1000	400	1	BBN0112810120006	1.578,40	1.857,00	2.600,30
1000	400	2	BBN0112810220006	2.474,90	2.911,80	4.076,20

LINGO SHELVING SYSTEM

DOUBLE-SIDED - HIGH WOODEN BACK PANEL - CASTOR PLATE - FOR TOP SHELF

Painted and veneered Lingo Shelving Systems are FSC-certified.

H920 mm

Module mm	Shelf depth mm	No. of bays	Item no.	Melamine EUR	Painted EUR	Veneer EUR
500	250	1	BBN0113450120006	880,50	1.035,80	1.450,70
500	250	2	BBN0113450220006	1.388,60	1.633,90	2.288,60
500	250	3	BBN0113450320006	1.964,20	2.310,90	3.236,00
500	300	1	BBN0113650120006	1.059,00	1.246,20	1.745,80
500	300	2	BBN0113650220006	1.657,10	1.950,30	2.731,20
500	300	3	BBN0113650320006	2.329,60	2.741,30	3.839,00
500	400	1	BBN0113850120006	1.372,10	1.613,90	2.259,40
500	400	2	BBN0113850220006	2.126,20	2.501,00	3.502,00
500	400	3	BBN0113850320006	2.962,50	3.484,40	4.879,40
750	250	1	BBN0113470120006	1.082,40	1.273,40	1.783,30
750	250	2	BBN0113470220006	1.726,40	2.030,70	2.842,90
750	250	3	BBN0113470320006	2.470,50	2.906,10	4.068,50
750	300	1	BBN0113670120006	1.276,30	1.501,90	2.102,80
750	300	2	BBN0113670220006	2.017,20	2.373,20	3.322,80
750	300	3	BBN0113670320006	2.869,40	3.375,90	4.727,00
750	400	1	BBN0113870120006	1.603,90	1.886,50	2.641,10
750	400	2	BBN0113870220006	2.508,60	2.950,20	4.130,70
750	400	3	BBN0113870320006	3.535,40	4.158,50	5.822,10
900	250	1	BBN0113490120006	1.214,10	1.428,60	1.999,80
900	250	2	BBN0113490220006	1.949,20	2.293,20	3.210,60
900	300	1	BBN0113690120006	1.416,80	1.667,10	2.333,80
900	300	2	BBN0113690220006	2.253,30	2.651,50	3.712,20
900	400	1	BBN0113890120006	1.753,10	2.062,00	2.887,50
900	400	2	BBN0113890220006	2.758,10	3.244,30	4.541,80
1000	250	1	BBN0113410120006	1.284,60	1.511,20	2.114,90
1000	250	2	BBN0113410220006	2.063,50	2.427,60	3.397,50
1000	300	1	BBN0113610120006	1.493,40	1.757,10	2.458,80
1000	300	2	BBN0113610220006	2.376,20	2.796,20	3.913,70
1000	400	1	BBN0113810120006	1.835,40	2.158,90	3.022,20
1000	400	2	BBN0113810220006	2.890,20	3.399,60	4.757,80

LINGO SHELVING SYSTEM

DOUBLE-SIDED - HIGH WOODEN BACK PANEL - CASTOR PLATE - FOR TOP SHELF

Painted and veneered Lingo Shelving Systems are FSC-certified.

H1220 mm

Module mm	Shelf depth mm	No. of bays	Item no.	Melamine EUR	Painted EUR	Veneer EUR
500	250	1	BBN0114450120006	1.078,20	1.268,70	1.777,10
500	250	2	BBN0114450220006	1.708,00	2.010,20	2.815,80
500	250	3	BBN0114450320006	2.405,30	2.830,60	3.964,00
500	300	1	BBN0114650120006	1.291,90	1.519,90	2.129,60
500	300	2	BBN0114650220006	2.029,30	2.387,80	3.344,50
500	300	3	BBN0114650320006	2.841,10	3.342,60	4.681,80
500	400	1	BBN0114850120006	1.690,20	1.988,80	2.784,80
500	400	2	BBN0114850220006	2.626,20	3.090,30	4.327,70
500	400	3	BBN0114850320006	3.644,40	4.288,10	6.005,40
750	250	1	BBN0114470120006	1.303,40	1.533,50	2.147,60
750	250	2	BBN0114470220006	2.092,40	2.461,40	3.445,90
750	250	3	BBN0114470320006	2.981,50	3.507,40	4.910,20
750	300	1	BBN0114670120006	1.532,50	1.802,80	2.524,50
750	300	2	BBN0114670220006	2.436,00	2.865,10	4.011,90
750	300	3	BBN0114670320006	3.450,80	4.058,80	5.683,50
750	400	1	BBN0114870120006	1.945,30	2.288,60	3.204,40
750	400	2	BBN0114870220006	3.055,20	3.593,90	5.032,20
750	400	3	BBN0114870320006	4.287,20	5.043,80	7.061,80
900	250	1	BBN0114490120006	1.440,30	1.694,80	2.373,50
900	250	2	BBN0114490220006	2.325,60	2.736,10	3.832,40
900	300	1	BBN0114690120006	1.678,20	1.974,10	2.764,90
900	300	2	BBN0114690220006	2.682,50	3.155,60	4.420,10
900	400	1	BBN0114890120006	2.099,70	2.470,20	3.460,20
900	400	2	BBN0114890220006	3.315,10	3.900,20	5.462,10
1000	250	1	BBN0114410120006	1.528,00	1.797,70	2.516,80
1000	250	2	BBN0114410220006	2.474,30	2.911,10	4.075,70
1000	300	1	BBN0114610120006	1.772,00	2.084,40	2.918,10
1000	300	2	BBN0114610220006	2.839,80	3.340,90	4.678,00
1000	400	1	BBN0114810120006	2.199,20	2.587,40	3.623,10
1000	400	2	BBN0114810220006	3.481,60	4.096,10	5.734,50

LINGO SHELVING SYSTEM

DOUBLE-SIDED - HIGH WOODEN BACK PANEL - CASTOR PLATE - FOR TOP SHELF

Painted and veneered Lingo Shelving Systems are FSC-certified.

H1520 mm

Module mm	Shelf depth mm	No. of bays	Item no.	Melamine EUR	Painted EUR	Veneer EUR
500	250	1	BBN0115450120006	1.192,60	1.402,60	1.963,50
500	250	2	BBN0115450220006	1.900,10	2.235,00	3.129,00
500	250	3	BBN0115450320006	2.675,10	3.146,30	4.404,00
500	300	1	BBN0115650120006	1.376,30	1.619,00	2.268,40
500	300	2	BBN0115650220006	2.176,40	2.560,40	3.586,30
500	300	3	BBN0115650320006	3.050,90	3.588,70	5.026,60
500	400	1	BBN0115850120006	1.793,40	2.110,10	2.954,00
500	400	2	BBN0115850220006	2.801,50	3.296,20	4.615,10
500	400	3	BBN0115850320006	3.891,80	4.578,60	6.411,00
750	250	1	BBN0115470120006	1.437,70	1.691,40	2.367,60
750	250	2	BBN0115470220006	2.324,30	2.734,20	3.826,30
750	250	3	BBN0115470320006	3.311,00	3.895,10	5.451,00
750	300	1	BBN0115670120006	1.636,80	1.925,90	2.696,90
750	300	2	BBN0115670220006	2.622,90	3.085,70	4.320,90
750	300	3	BBN0115670320006	3.720,30	4.376,90	6.129,10
750	400	1	BBN0115870120006	2.068,40	2.433,90	3.407,20
750	400	2	BBN0115870220006	3.270,30	3.847,80	5.386,80
750	400	3	BBN0115870320006	4.594,30	5.406,30	7.568,20
900	250	1	BBN0115490120006	1.592,70	1.873,80	2.623,00
900	250	2	BBN0115490220006	2.593,70	3.051,10	4.271,80
900	300	1	BBN0115690120006	1.800,60	2.118,30	2.966,80
900	300	2	BBN0115690220006	2.905,60	3.418,40	4.788,10
900	400	1	BBN0115890120006	2.240,90	2.636,60	3.692,50
900	400	2	BBN0115890220006	3.566,40	4.196,30	5.875,70
1000	250	1	BBN0115410120006	1.683,90	1.981,00	2.771,80
1000	250	2	BBN0115410220006	2.749,40	3.234,70	4.526,10
1000	300	1	BBN0115610120006	1.897,90	2.232,90	3.125,50
1000	300	2	BBN0115610220006	3.069,90	3.612,30	5.057,00
1000	400	1	BBN0115810120006	2.343,90	2.758,10	3.860,90
1000	400	2	BBN0115810220006	3.739,90	4.400,80	6.159,10

LINGO SHELVING SYSTEM

BBN011 - LOW WOODEN BACK PANEL - CASTOR PLATE - FOR TOP SHELF



LINGO SHELVING SYSTEM

BBN011 - LOW WOODEN BACK PANEL - CASTOR PLATE - FOR TOP SHELF

Shelving system with wooden panels, low wooden back panel and castor plate.
To be used with ST1 full depth, WT1 full depth and WT1 double-sided top shelf.

- Prices based on steel price group 1 and wooden price group A (see Design Options pages 6-9).
- For top shelves, see pages 156 & 174
- For shelves see page 144 & 166.
- For accessories see page 186.

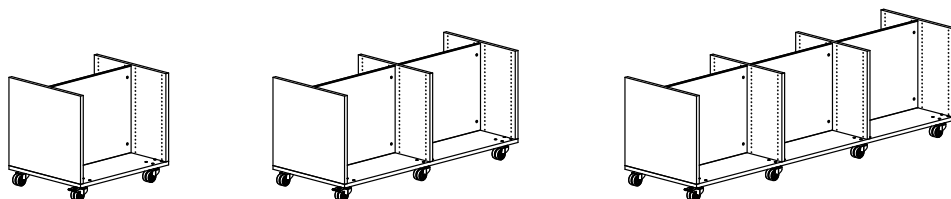

Double-sided H720 mm - 1/2/3 bays

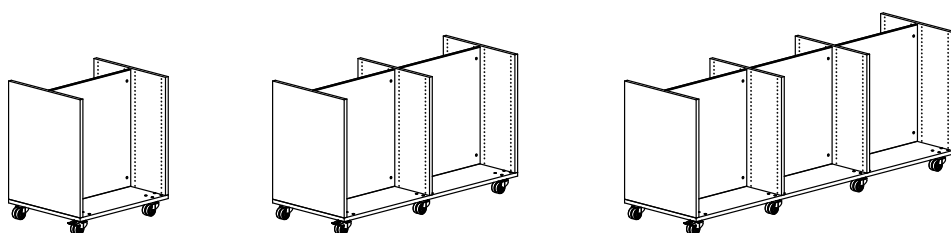

Double-sided H920 mm - 1/2/3 bays

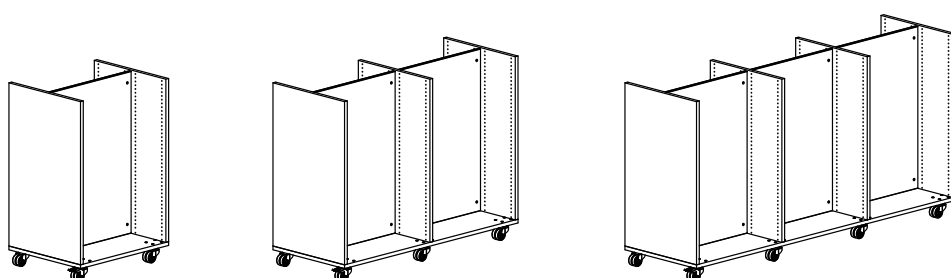

Double-sided H1220 mm - 1/2/3 bays

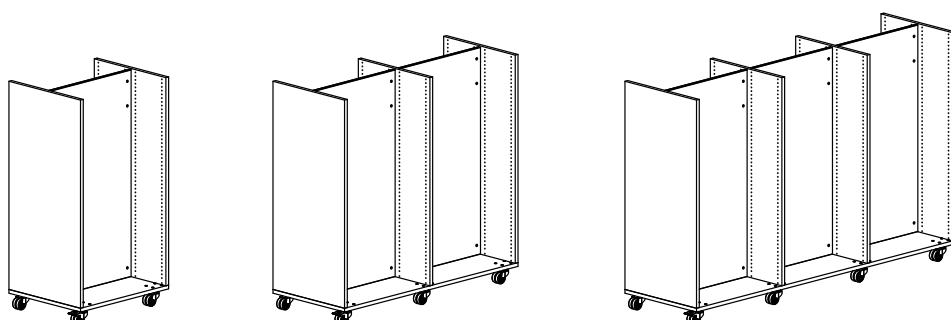

Double-sided H1520 mm - 1/2/3 bays

LINGO SHELVING SYSTEM

DOUBLE-SIDED - LOW WOODEN BACK PANEL - CASTOR PLATE - FOR TOP SHELF

Painted and veneered Lingo Shelving Systems are FSC-certified.

H720 mm

Module mm	Shelf depth mm	No. of bays	Item no.	Melamine EUR	Painted EUR	Veneer EUR
500	250	1	BBN011245011000.	747,60	879,00	1.230,90
500	250	2	BBN011245021000.	1.174,40	1.381,10	1.934,20
500	250	3	BBN011245031000.	1.668,70	1.962,10	2.747,00
500	300	1	BBN011265011000.	893,30	1.050,40	1.472,00
500	300	2	BBN011265021000.	1.393,70	1.639,00	2.295,80
500	300	3	BBN011265031000.	1.968,50	2.314,50	3.242,00
500	400	1	BBN011285011000.	1.145,00	1.346,70	1.885,60
500	400	2	BBN011285021000.	1.770,70	2.082,60	2.916,60
500	400	3	BBN011285031000.	2.478,60	2.914,80	4.082,40
750	250	1	BBN011247011000.	934,40	1.099,30	1.539,80
750	250	2	BBN011247021000.	1.482,00	1.743,30	2.441,10
750	250	3	BBN011247031000.	2.129,70	2.505,40	3.508,40
750	300	1	BBN011267011000.	1.095,50	1.288,80	1.805,30
750	300	2	BBN011267021000.	1.723,60	2.027,30	2.840,00
750	300	3	BBN011267031000.	2.463,00	2.897,20	4.058,90
750	400	1	BBN011287011000.	1.361,70	1.602,00	2.243,60
750	400	2	BBN011287021000.	2.122,90	2.497,20	3.497,90
750	400	3	BBN011287031000.	3.006,20	3.537,00	4.954,00
900	250	1	BBN011249011000.	1.055,00	1.241,00	1.737,30
900	250	2	BBN011249021000.	1.682,60	1.978,80	2.770,80
900	300	1	BBN011269011000.	1.224,90	1.440,50	2.017,30
900	300	2	BBN011269021000.	1.937,50	2.278,60	3.191,40
900	400	1	BBN011289011000.	1.499,80	1.764,00	2.471,00
900	400	2	BBN011289021000.	2.350,20	2.764,30	3.871,00
1000	250	1	BBN011241011000.	1.121,80	1.319,70	1.847,00
1000	250	2	BBN011241021000.	1.789,50	2.105,40	2.946,90
1000	300	1	BBN011261011000.	1.297,80	1.526,60	2.136,90
1000	300	2	BBN011261021000.	2.053,00	2.415,50	3.382,10
1000	400	1	BBN011281011000.	1.578,40	1.857,00	2.600,30
1000	400	2	BBN011281021000.	2.474,90	2.911,80	4.076,20

LINGO SHELVING SYSTEM

DOUBLE-SIDED - LOW WOODEN BACK PANEL - CASTOR PLATE - FOR TOP SHELF

Painted and veneered Lingo Shelving Systems are FSC-certified.

H920 mm

Module mm	Shelf depth mm	No. of bays	Item no.	Melamine EUR	Painted EUR	Veneer EUR
500	250	1	BBN011345011000.	880,50	1.035,80	1.450,70
500	250	2	BBN011345021000.	1.388,60	1.633,90	2.288,60
500	250	3	BBN011345031000.	1.964,20	2.310,90	3.236,00
500	300	1	BBN011365011000.	1.059,00	1.246,20	1.745,80
500	300	2	BBN011365021000.	1.657,10	1.950,30	2.731,20
500	300	3	BBN011365031000.	2.329,60	2.741,30	3.839,00
500	400	1	BBN011385011000.	1.372,10	1.613,90	2.259,40
500	400	2	BBN011385021000.	2.126,20	2.501,00	3.502,00
500	400	3	BBN011385031000.	2.962,50	3.484,40	4.879,40
750	250	1	BBN011347011000.	1.082,40	1.273,40	1.783,30
750	250	2	BBN011347021000.	1.726,40	2.030,70	2.842,90
750	250	3	BBN011347031000.	2.470,50	2.906,10	4.068,50
750	300	1	BBN011367011000.	1.276,30	1.501,90	2.102,80
750	300	2	BBN011367021000.	2.017,20	2.373,20	3.322,80
750	300	3	BBN011367031000.	2.869,40	3.375,90	4.727,00
750	400	1	BBN011387011000.	1.603,90	1.886,50	2.641,10
750	400	2	BBN011387021000.	2.508,60	2.950,20	4.130,70
750	400	3	BBN011387031000.	3.535,40	4.158,50	5.822,10
900	250	1	BBN011349011000.	1.214,10	1.428,60	1.999,80
900	250	2	BBN011349021000.	1.949,20	2.293,20	3.210,60
900	300	1	BBN011369011000.	1.416,80	1.667,10	2.333,80
900	300	2	BBN011369021000.	2.253,30	2.651,50	3.712,20
900	400	1	BBN011389011000.	1.753,10	2.062,00	2.887,50
900	400	2	BBN011389021000.	2.758,10	3.244,30	4.541,80
1000	250	1	BBN011341011000.	1.284,60	1.511,20	2.114,90
1000	250	2	BBN011341021000.	2.063,50	2.427,60	3.397,50
1000	300	1	BBN011361011000.	1.493,40	1.757,10	2.458,80
1000	300	2	BBN011361021000.	2.376,20	2.796,20	3.913,70
1000	400	1	BBN011381011000.	1.835,40	2.158,90	3.022,20
1000	400	2	BBN011381021000.	2.890,20	3.399,60	4.757,80

LINGO SHELVING SYSTEM

DOUBLE-SIDED - LOW WOODEN BACK PANEL - CASTOR PLATE - FOR TOP SHELF

Painted and veneered Lingo Shelving Systems are FSC-certified.

H1220 mm

Module mm	Shelf depth mm	No. of bays	Item no.	Melamine EUR	Painted EUR	Veneer EUR
500	250	1	BBN011445011000.	1.078,20	1.268,70	1.777,10
500	250	2	BBN011445021000.	1.708,00	2.010,20	2.815,80
500	250	3	BBN011445031000.	2.405,30	2.830,60	3.964,00
500	300	1	BBN011465011000.	1.291,90	1.519,90	2.129,60
500	300	2	BBN011465021000.	2.029,30	2.387,80	3.344,50
500	300	3	BBN011465031000.	2.841,10	3.342,60	4.681,80
500	400	1	BBN011485011000.	1.690,20	1.988,80	2.784,80
500	400	2	BBN011485021000.	2.626,20	3.090,30	4.327,70
500	400	3	BBN011485031000.	3.644,40	4.288,10	6.005,40
750	250	1	BBN011447011000.	1.303,40	1.533,50	2.147,60
750	250	2	BBN011447021000.	2.092,40	2.461,40	3.445,90
750	250	3	BBN011447031000.	2.981,50	3.507,40	4.910,20
750	300	1	BBN011467011000.	1.532,50	1.802,80	2.524,50
750	300	2	BBN011467021000.	2.436,00	2.865,10	4.011,90
750	300	3	BBN011467031000.	3.450,80	4.058,80	5.683,50
750	400	1	BBN011487011000.	1.945,30	2.288,60	3.204,40
750	400	2	BBN011487021000.	3.055,20	3.593,90	5.032,20
750	400	3	BBN011487031000.	4.287,20	5.043,80	7.061,80
900	250	1	BBN011449011000.	1.440,30	1.694,80	2.373,50
900	250	2	BBN011449021000.	2.325,60	2.736,10	3.832,40
900	300	1	BBN011469011000.	1.678,20	1.974,10	2.764,90
900	300	2	BBN011469021000.	2.682,50	3.155,60	4.420,10
900	400	1	BBN011489011000.	2.099,70	2.470,20	3.460,20
900	400	2	BBN011489021000.	3.315,10	3.900,20	5.462,10
1000	250	1	BBN011441011000.	1.528,00	1.797,70	2.516,80
1000	250	2	BBN011441021000.	2.474,30	2.911,10	4.075,70
1000	300	1	BBN011461011000.	1.772,00	2.084,40	2.918,10
1000	300	2	BBN011461021000.	2.839,80	3.340,90	4.678,00
1000	400	1	BBN011481011000.	2.199,20	2.587,40	3.623,10
1000	400	2	BBN011481021000.	3.481,60	4.096,10	5.734,50

LINGO SHELVING SYSTEM

DOUBLE-SIDED - LOW WOODEN BACK PANEL - CASTOR PLATE - FOR TOP SHELF

Painted and veneered Lingo Shelving Systems are FSC-certified.

H1520 mm

Module mm	Shelf depth mm	No. of bays	Item no.	Melamine EUR	Painted EUR	Veneer EUR
500	250	1	BBN011545011000.	1.192,60	1.402,60	1.963,50
500	250	2	BBN011545021000.	1.900,10	2.235,00	3.129,00
500	250	3	BBN011545031000.	2.675,10	3.146,30	4.404,00
500	300	1	BBN011565011000.	1.376,30	1.619,00	2.268,40
500	300	2	BBN011565021000.	2.176,40	2.560,40	3.586,30
500	300	3	BBN011565031000.	3.050,90	3.588,70	5.026,60
500	400	1	BBN011585011000.	1.793,40	2.110,10	2.954,00
500	400	2	BBN011585021000.	2.801,50	3.296,20	4.615,10
500	400	3	BBN011585031000.	3.891,80	4.578,60	6.411,00
750	250	1	BBN011547011000.	1.437,70	1.691,40	2.367,60
750	250	2	BBN011547021000.	2.324,30	2.734,20	3.826,30
750	250	3	BBN011547031000.	3.311,00	3.895,10	5.451,00
750	300	1	BBN011567011000.	1.636,80	1.925,90	2.696,90
750	300	2	BBN011567021000.	2.622,90	3.085,70	4.320,90
750	300	3	BBN011567031000.	3.720,30	4.376,90	6.129,10
750	400	1	BBN011587011000.	2.068,40	2.433,90	3.407,20
750	400	2	BBN011587021000.	3.270,30	3.847,80	5.386,80
750	400	3	BBN011587031000.	4.594,30	5.406,30	7.568,20
900	250	1	BBN011549011000.	1.592,70	1.873,80	2.623,00
900	250	2	BBN011549021000.	2.593,70	3.051,10	4.271,80
900	300	1	BBN011569011000.	1.800,60	2.118,30	2.966,80
900	300	2	BBN011569021000.	2.905,60	3.418,40	4.788,10
900	400	1	BBN011589011000.	2.240,90	2.636,60	3.692,50
900	400	2	BBN011589021000.	3.566,40	4.196,30	5.875,70
1000	250	1	BBN011541011000.	1.683,90	1.981,00	2.771,80
1000	250	2	BBN011541021000.	2.749,40	3.234,70	4.526,10
1000	300	1	BBN011561011000.	1.897,90	2.232,90	3.125,50
1000	300	2	BBN011561021000.	3.069,90	3.612,30	5.057,00
1000	400	1	BBN011581011000.	2.343,90	2.758,10	3.860,90
1000	400	2	BBN011581021000.	3.739,90	4.400,80	6.159,10

LINGO SHELVING SYSTEM

BBN011 - CROSS BRACE - CASTOR PLATE - FOR TOP SHELF



LINGO SHELVING SYSTEM

BBN011 - CROSS BRACE - CASTOR PLATE - FOR TOP SHELF

Shelving system with wooden panels, cross brace and castor plate.

To be used with top shelf.

Middle shelf must be screwed into panels for H1520 mm.

- Prices based on steel price group 1 and wooden price group A (see Design Options pages 6-9).

- For top shelves, see pages 156 & 174

- For shelves see page 144 & 166.

- For accessories see page 186.

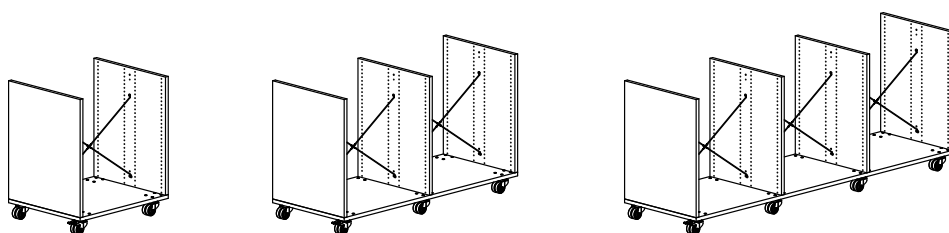

Double-sided H920 mm - 1/2/3 bays

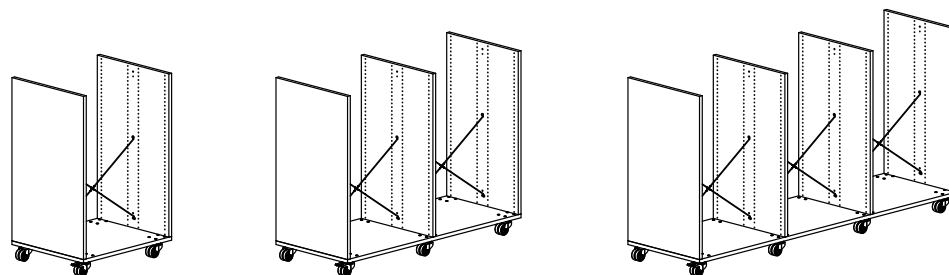

Double-sided H1220 mm - 1/2/3 bays

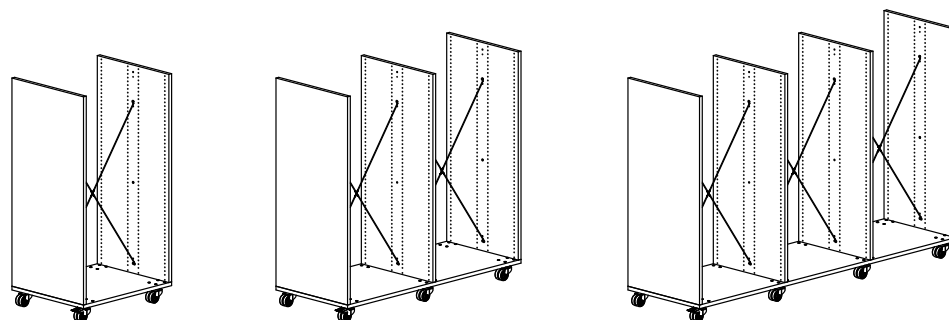

Double-sided H1520 mm - 1/2/3 bays

LINGO SHELVING SYSTEM

DOUBLE-SIDED - CROSS BRACE - CASTOR PLATE - FOR TOP SHELF

Painted and veneered Lingo Shelving Systems are FSC-certified.

H920 mm

Module mm	Shelf depth mm	No. of bays	Item no.	Melamine EUR	Painted EUR	Veneer EUR
500	250	1	BBN011345019000.	765,70	896,80	1.247,00
500	250	2	BBN011345029000.	1.159,00	1.355,90	1.881,20
500	250	3	BBN011345039000.	1.619,80	1.893,90	2.624,90
500	300	1	BBN011365019000.	944,20	1.107,20	1.542,10
500	300	2	BBN011365029000.	1.427,50	1.672,30	2.323,80
500	300	3	BBN011365039000.	1.985,20	2.324,30	3.227,90
500	400	1	BBN011385019000.	1.257,30	1.474,90	2.055,70
500	400	2	BBN011385029000.	1.896,60	2.223,00	3.094,60
500	400	3	BBN011385039000.	2.618,10	3.067,40	4.268,30
750	250	1	BBN011347019000.	899,20	1.054,10	1.467,40
750	250	2	BBN011347029000.	1.360,00	1.592,10	2.211,10
750	250	3	BBN011347039000.	1.920,90	2.248,20	3.120,80
750	300	1	BBN011367019000.	1.093,10	1.282,60	1.786,90
750	300	2	BBN011367029000.	1.650,80	1.934,60	2.691,00
750	300	3	BBN011367039000.	2.319,80	2.718,00	3.779,30
750	400	1	BBN011387019000.	1.420,70	1.667,20	2.325,20
750	400	2	BBN011387029000.	2.142,20	2.511,60	3.498,90
750	400	3	BBN011387039000.	2.985,80	3.500,60	4.874,40
900	250	1	BBN011349019000.	979,70	1.148,90	1.599,50
900	250	2	BBN011349029000.	1.480,40	1.733,80	2.410,00
900	300	1	BBN011369019000.	1.182,40	1.387,40	1.933,50
900	300	2	BBN011369029000.	1.784,50	2.092,10	2.911,60
900	400	1	BBN011389019000.	1.518,70	1.782,30	2.487,20
900	400	2	BBN011389029000.	2.289,30	2.684,90	3.741,20
1000	250	1	BBN011341019000.	1.033,20	1.211,60	1.687,30
1000	250	2	BBN011341029000.	1.560,70	1.828,40	2.542,30
1000	300	1	BBN011361019000.	1.242,00	1.457,50	2.031,20
1000	300	2	BBN011361029000.	1.873,40	2.197,00	3.058,50
1000	400	1	BBN011381019000.	1.584,00	1.859,30	2.594,60
1000	400	2	BBN011381029000.	2.387,40	2.800,40	3.902,60

LINGO SHELVING SYSTEM

DOUBLE-SIDED - CROSS BRACE - CASTOR PLATE - FOR TOP SHELF

Painted and veneered Lingo Shelving Systems are FSC-certified.

H1220 mm

Module mm	Shelf depth mm	No. of bays	Item no.	Melamine EUR	Painted EUR	Veneer EUR
500	250	1	BBN011445019000.	917,70	1.075,80	1.498,20
500	250	2	BBN011445029000.	1.387,00	1.624,40	2.258,00
500	250	3	BBN011445039000.	1.923,80	2.251,90	3.127,30
500	300	1	BBN011465019000.	1.131,40	1.327,00	1.850,70
500	300	2	BBN011465029000.	1.708,30	2.002,00	2.786,70
500	300	3	BBN011465039000.	2.359,60	2.763,90	3.845,10
500	400	1	BBN011485019000.	1.529,70	1.795,90	2.505,90
500	400	2	BBN011485029000.	2.305,20	2.704,50	3.769,90
500	400	3	BBN011485039000.	3.162,90	3.709,40	5.168,70
750	250	1	BBN011447019000.	1.051,20	1.233,10	1.718,60
750	250	2	BBN011447029000.	1.588,00	1.860,60	2.587,90
750	250	3	BBN011447039000.	2.224,90	2.606,20	3.623,20
750	300	1	BBN011467019000.	1.280,30	1.502,40	2.095,50
750	300	2	BBN011467029000.	1.931,60	2.264,30	3.153,90
750	300	3	BBN011467039000.	2.694,20	3.157,60	4.396,50
750	400	1	BBN011487019000.	1.693,10	1.988,20	2.775,40
750	400	2	BBN011487029000.	2.550,80	2.993,10	4.174,20
750	400	3	BBN011487039000.	3.530,60	4.142,60	5.774,80
900	250	1	BBN011449019000.	1.131,70	1.327,90	1.850,70
900	250	2	BBN011449029000.	1.708,40	2.002,30	2.786,80
900	300	1	BBN011469019000.	1.369,60	1.607,20	2.242,10
900	300	2	BBN011469029000.	2.065,30	2.421,80	3.374,50
900	400	1	BBN011489019000.	1.791,10	2.103,30	2.937,40
900	400	2	BBN011489029000.	2.697,90	3.166,40	4.416,50
1000	250	1	BBN011441019000.	1.185,20	1.390,60	1.938,50
1000	250	2	BBN011441029000.	1.788,70	2.096,90	2.919,10
1000	300	1	BBN011461019000.	1.429,20	1.677,30	2.339,80
1000	300	2	BBN011461029000.	2.154,20	2.526,70	3.521,40
1000	400	1	BBN011481019000.	1.856,40	2.180,30	3.044,80
1000	400	2	BBN011481029000.	2.796,00	3.281,90	4.577,90

LINGO SHELVING SYSTEM

DOUBLE-SIDED - CROSS BRACE - CASTOR PLATE - FOR TOP SHELF

Painted and veneered Lingo Shelving Systems are FSC-certified.

H1520 mm

Module mm	Shelf depth mm	No. of bays	Item no.	Melamine EUR	Painted EUR	Veneer EUR
500	250	1	BBN011545019000.	991,10	1.161,80	1.617,40
500	250	2	BBN011545029000.	1.497,10	1.753,40	2.436,80
500	250	3	BBN011545039000.	2.070,60	2.423,90	3.365,70
500	300	1	BBN011565019000.	1.174,80	1.378,20	1.922,30
500	300	2	BBN011565029000.	1.773,40	2.078,80	2.894,10
500	300	3	BBN011565039000.	2.446,40	2.866,30	3.988,30
500	400	1	BBN011585019000.	1.591,90	1.869,30	2.607,90
500	400	2	BBN011585029000.	2.398,50	2.814,60	3.922,90
500	400	3	BBN011585039000.	3.287,30	3.856,20	5.372,70
750	250	1	BBN011547019000.	1.124,60	1.319,10	1.837,80
750	250	2	BBN011547029000.	1.698,10	1.989,60	2.766,70
750	250	3	BBN011547039000.	2.371,70	2.778,20	3.861,60
750	300	1	BBN011567019000.	1.323,70	1.553,60	2.167,10
750	300	2	BBN011567029000.	1.996,70	2.341,10	3.261,30
750	300	3	BBN011567039000.	2.781,00	3.260,00	4.539,70
750	400	1	BBN011587019000.	1.755,30	2.061,60	2.877,40
750	400	2	BBN011587029000.	2.644,10	3.103,20	4.327,20
750	400	3	BBN011587039000.	3.655,00	4.289,40	5.978,80
900	250	1	BBN011549019000.	1.205,10	1.413,90	1.969,90
900	250	2	BBN011549029000.	1.818,50	2.131,30	2.965,60
900	300	1	BBN011569019000.	1.413,00	1.658,40	2.313,70
900	300	2	BBN011569029000.	2.130,40	2.498,60	3.481,90
900	400	1	BBN011589019000.	1.853,30	2.176,70	3.039,40
900	400	2	BBN011589029000.	2.791,20	3.276,50	4.569,50
1000	250	1	BBN011541019000.	1.258,60	1.476,60	2.057,70
1000	250	2	BBN011541029000.	1.898,80	2.225,90	3.097,90
1000	300	1	BBN011561019000.	1.472,60	1.728,50	2.411,40
1000	300	2	BBN011561029000.	2.219,30	2.603,50	3.628,80
1000	400	1	BBN011581019000.	1.918,60	2.253,70	3.146,80
1000	400	2	BBN011581029000.	2.889,30	3.392,00	4.730,90



LINGO SHELVING SYSTEM

BBN012 - STEEL BACK FRAME - CASTOR PLATE - WITH OVERLAYING WOODEN TOP PLATE



LINGO SHELVING SYSTEM

BBN012 - STEEL BACK FRAME - CASTOR PLATE - WITH OVERLAYING WOODEN TOP PLATE

Shelving system with wooden panels, metal back frame, castor plate and overlaying top plate.

- Prices based on steel price group 1 and wooden price group A (see Design Options pages 6-9).
- For shelves see page 144 & 166.
- For accessories see page 186.

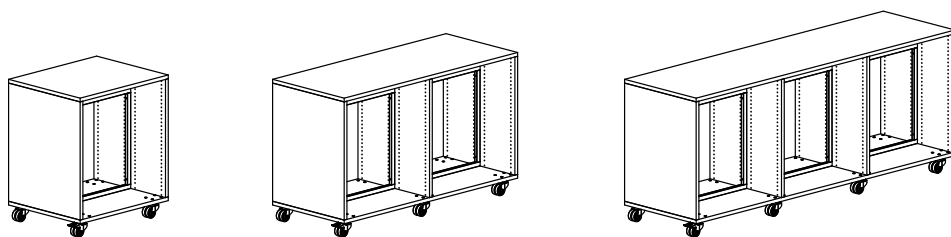

Double-sided H920 mm - 1/2/3 bays

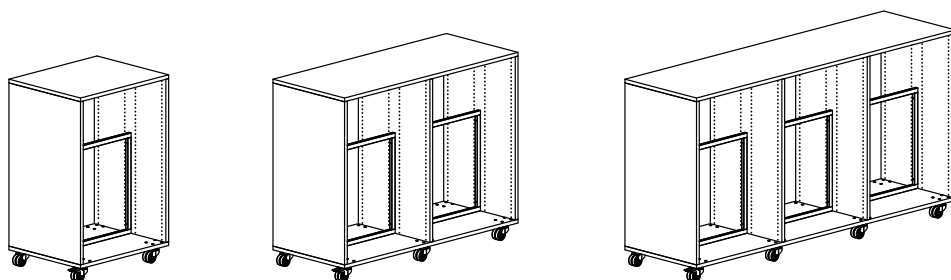

Double-sided H1220 mm - 1/2/3 bays

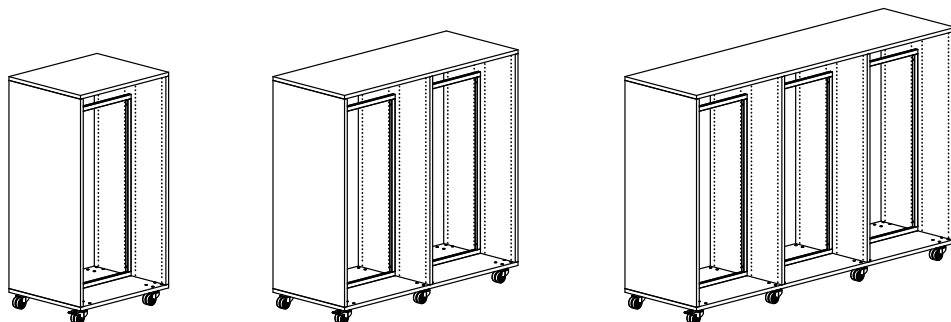

Double-sided H1520 mm - 1/2/3 bays

LINGO SHELVING SYSTEM

DOUBLE-SIDED - STEEL BACK FRAME - CASTOR PLATE - WITH OVERLAYING WOODEN TOP PLATE

Painted and veneered Lingo Shelving Systems are FSC-certified.

H920 mm

Module mm	Shelf depth mm	No. of bays	Item no.	Melamine EUR	Painted EUR	Veneer EUR
500	250	1	BBN012345016100.	986,50	1.146,40	1.573,50
500	250	2	BBN012345026100.	1.567,10	1.816,10	2.480,00
500	250	3	BBN012345036100.	2.232,30	2.584,50	3.524,20
500	300	1	BBN012365016100.	1.182,80	1.378,10	1.898,70
500	300	2	BBN012365026100.	1.868,20	2.171,00	2.976,70
500	300	3	BBN012365036100.	2.646,70	3.072,60	4.207,90
500	400	1	BBN012385016100.	1.514,30	1.767,10	2.442,40
500	400	2	BBN012385026100.	2.370,10	2.760,40	3.801,40
500	400	3	BBN012385036100.	3.328,70	3.873,70	5.329,20
750	250	1	BBN012347016100.	1.201,90	1.400,60	1.929,20
750	250	2	BBN012347026100.	1.916,00	2.226,20	3.053,50
750	250	3	BBN012347036100.	2.754,60	3.199,10	4.384,40
750	300	1	BBN012367016100.	1.423,40	1.660,90	2.293,80
750	300	2	BBN012367026100.	2.255,60	2.626,20	3.614,10
750	300	3	BBN012367036100.	3.227,70	3.755,90	5.164,80
750	400	1	BBN012387016100.	1.778,10	2.077,60	2.877,20
750	400	2	BBN012387026100.	2.796,10	3.261,20	4.503,10
750	400	3	BBN012387036100.	3.967,40	4.625,60	6.381,00
900	250	1	BBN012349016100.	1.282,40	1.495,40	2.061,30
900	250	2	BBN012349026100.	2.036,40	2.367,90	3.252,40
900	300	1	BBN012369016100.	1.512,70	1.765,70	2.440,40
900	300	2	BBN012369026100.	2.389,30	2.783,70	3.834,70
900	400	1	BBN012389016100.	1.876,10	2.192,70	3.039,20
900	400	2	BBN012389026100.	2.943,20	3.434,50	4.745,40
1000	250	1	BBN012341016100.	1.374,00	1.600,40	2.204,70
1000	250	2	BBN012341026100.	2.186,50	2.541,00	3.486,40
1000	300	1	BBN012361016100.	1.613,00	1.882,10	2.598,40
1000	300	2	BBN012361026100.	2.553,90	2.973,90	4.092,50
1000	400	1	BBN012381016100.	1.985,10	2.319,30	3.211,70
1000	400	2	BBN012381026100.	3.122,30	3.641,40	5.026,90

LINGO SHELVING SYSTEM

DOUBLE-SIDED - STEEL BACK FRAME - CASTOR PLATE - WITH OVERLAYING WOODEN TOP PLATE

Painted and veneered Lingo Shelving Systems are FSC-certified.

H1220 mm

Module mm	Shelf depth mm	No. of bays	Item no.	Melamine EUR	Painted EUR	Veneer EUR
500	250	1	BBN012445016100.	1.138,50	1.325,40	1.824,70
500	250	2	BBN012445026100.	1.795,10	2.084,60	2.856,80
500	250	3	BBN012445036100.	2.536,30	2.942,50	4.026,60
500	300	1	BBN012465016100.	1.370,00	1.597,90	2.207,30
500	300	2	BBN012465026100.	2.149,00	2.500,70	3.439,60
500	300	3	BBN012465036100.	3.021,10	3.512,20	4.825,10
500	400	1	BBN012485016100.	1.786,70	2.088,10	2.892,60
500	400	2	BBN012485026100.	2.778,70	3.241,90	4.476,70
500	400	3	BBN012485036100.	3.873,50	4.515,70	6.229,60
750	250	1	BBN012447016100.	1.353,90	1.579,60	2.180,40
750	250	2	BBN012447026100.	2.144,00	2.494,70	3.430,30
750	250	3	BBN012447036100.	3.058,60	3.557,10	4.886,80
750	300	1	BBN012467016100.	1.610,60	1.880,70	2.602,40
750	300	2	BBN012467026100.	2.536,40	2.955,90	4.077,00
750	300	3	BBN012467036100.	3.602,10	4.195,50	5.782,00
750	400	1	BBN012487016100.	2.050,50	2.398,60	3.327,40
750	400	2	BBN012487026100.	3.204,70	3.742,70	5.178,40
750	400	3	BBN012487036100.	4.512,20	5.267,60	7.281,40
900	250	1	BBN012449016100.	1.434,40	1.674,40	2.312,50
900	250	2	BBN012449026100.	2.264,40	2.636,40	3.629,20
900	300	1	BBN012469016100.	1.699,90	1.985,50	2.749,00
900	300	2	BBN012469026100.	2.670,10	3.113,40	4.297,60
900	400	1	BBN012489016100.	2.148,50	2.513,70	3.489,40
900	400	2	BBN012489026100.	3.351,80	3.916,00	5.420,70
1000	250	1	BBN012441016100.	1.526,00	1.779,40	2.455,90
1000	250	2	BBN012441026100.	2.414,50	2.809,50	3.863,20
1000	300	1	BBN012461016100.	1.800,20	2.101,90	2.907,00
1000	300	2	BBN012461026100.	2.834,70	3.303,60	4.555,40
1000	400	1	BBN012481016100.	2.257,50	2.640,30	3.661,90
1000	400	2	BBN012481026100.	3.530,90	4.122,90	5.702,20

LINGO SHELVING SYSTEM

DOUBLE-SIDED - STEEL BACK FRAME - CASTOR PLATE - WITH OVERLAYING WOODEN TOP PLATE

Painted and veneered Lingo Shelving Systems are FSC-certified.

H1520 mm

Module mm	Shelf depth mm	No. of bays	Item no.	Melamine EUR	Painted EUR	Veneer EUR
500	250	1	BBN012545016100.	1.235,40	1.434,90	1.967,40
500	250	2	BBN012545026100.	1.952,20	2.260,60	3.082,60
500	250	3	BBN012545036100.	2.753,60	3.185,00	4.335,50
500	300	1	BBN012565016100.	1.436,90	1.672,60	2.302,40
500	300	2	BBN012565026100.	2.261,10	2.624,50	3.594,00
500	300	3	BBN012565036100.	3.178,40	3.685,10	5.038,80
500	400	1	BBN012585016100.	1.872,40	2.185,00	3.018,10
500	400	2	BBN012585026100.	2.919,00	3.399,00	4.676,70
500	400	3	BBN012585036100.	4.068,40	4.733,00	6.504,10
750	250	1	BBN012547016100.	1.450,80	1.689,10	2.323,10
750	250	2	BBN012547026100.	2.301,10	2.670,70	3.656,10
750	250	3	BBN012547036100.	3.275,90	3.799,60	5.195,70
750	300	1	BBN012567016100.	1.677,50	1.955,40	2.697,50
750	300	2	BBN012567026100.	2.648,50	3.079,70	4.231,40
750	300	3	BBN012567036100.	3.759,40	4.368,40	5.995,70
750	400	1	BBN012587016100.	2.136,20	2.495,50	3.452,90
750	400	2	BBN012587026100.	3.345,00	3.899,80	5.378,40
750	400	3	BBN012587036100.	4.707,10	5.484,90	7.555,90
900	250	1	BBN012549016100.	1.531,30	1.783,90	2.455,20
900	250	2	BBN012549026100.	2.421,50	2.812,40	3.855,00
900	300	1	BBN012569016100.	1.766,80	2.060,20	2.844,10
900	300	2	BBN012569026100.	2.782,20	3.237,20	4.452,00
900	400	1	BBN012589016100.	2.234,20	2.610,60	3.614,90
900	400	2	BBN012589026100.	3.492,10	4.073,10	5.620,70
1000	250	1	BBN012541016100.	1.625,70	1.891,70	2.601,40
1000	250	2	BBN012541026100.	2.577,20	2.991,10	4.094,60
1000	300	1	BBN012561016100.	1.869,90	2.179,40	3.004,90
1000	300	2	BBN012561026100.	2.952,40	3.433,00	4.715,40
1000	400	1	BBN012581016100.	2.346,00	2.740,00	3.790,20
1000	400	2	BBN012581026100.	3.676,80	4.285,60	5.907,80



LINGO SHELVING SYSTEM

BBN012 - WOODEN BACK PANEL - CASTOR PLATE - WITH OVERLAYING WOODEN TOP PLATE



LINGO SHELVING SYSTEM

BBN012 - WOODEN BACK PANEL - CASTOR PLATE - WITH OVERLAYING WOODEN TOP PLATE

Shelving system with wooden panels, wooden back panel, castor plate and overlaying top plate.

- Prices based on steel price group 1 and wooden price group A (see Design Options pages 6-9).
- For shelves see page 144 & 166.
- For accessories see page 186.

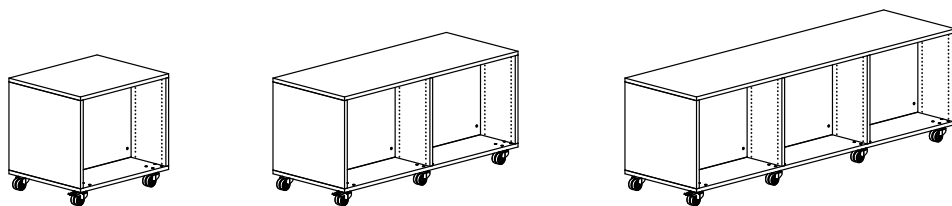

Double-sided H720 mm - 1/2/3 bays

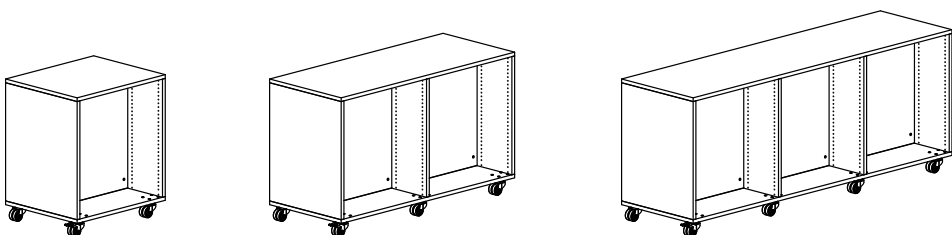

Double-sided H920 mm - 1/2/3 bays

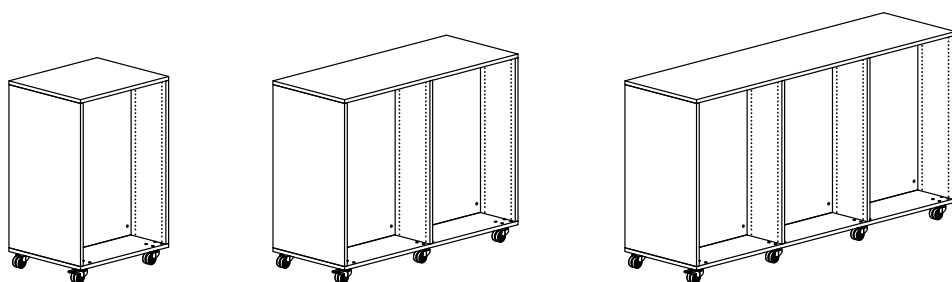

Double-sided H1220 mm - 1/2/3 bays

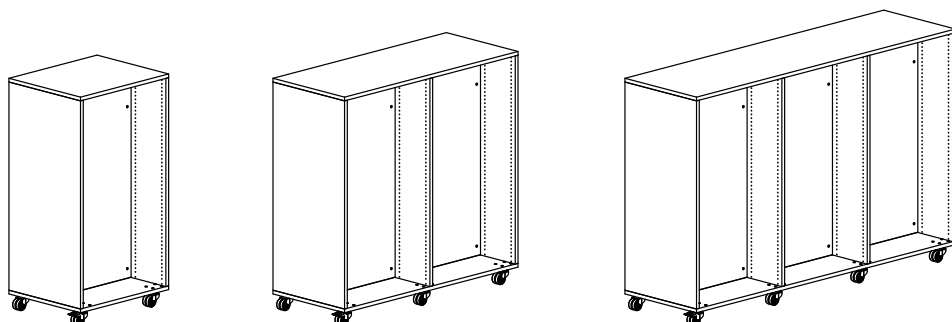

Double-sided H1520 mm - 1/2/3 bays

LINGO SHELVING SYSTEM

DOUBLE-SIDED - WOODEN BACK PANEL - CASTOR PLATE - WITH OVERLAYING WOODEN TOP PLATE

Painted and veneered Lingo Shelving Systems are FSC-certified.

H720 mm

Module mm	Shelf depth mm	No. of bays	Item no.	Melamine EUR	Painted EUR	Veneer EUR
500	250	1	BBN012245012100.	911,90	1.072,10	1.500,90
500	250	2	BBN012245022100.	1.469,50	1.728,30	2.420,00
500	250	3	BBN012245032100.	2.111,70	2.483,20	3.476,80
500	300	1	BBN012265012100.	1.075,40	1.264,80	1.772,10
500	300	2	BBN012265022100.	1.721,40	2.024,70	2.835,70
500	300	3	BBN012265032100.	2.460,50	2.893,30	4.052,50
500	400	1	BBN012285012100.	1.345,50	1.582,40	2.215,80
500	400	2	BBN012285022100.	2.131,20	2.507,00	3.510,40
500	400	3	BBN012285032100.	3.019,70	3.551,60	4.973,80
750	250	1	BBN012247012100.	1.180,60	1.389,30	1.945,10
750	250	2	BBN012247022100.	1.925,00	2.264,40	3.170,50
750	250	3	BBN012247032100.	2.793,90	3.286,80	4.602,50
750	300	1	BBN012267012100.	1.369,30	1.610,60	2.255,70
750	300	2	BBN012267022100.	2.215,40	2.605,90	3.650,10
750	300	3	BBN012267032100.	3.201,40	3.765,60	5.274,90
750	400	1	BBN012287012100.	1.662,60	1.955,90	2.739,10
750	400	2	BBN012287022100.	2.663,80	3.133,80	4.389,10
750	400	3	BBN012287032100.	3.818,30	4.492,50	6.291,10
900	250	1	BBN012249012100.	1.301,20	1.531,00	2.142,60
900	250	2	BBN012249022100.	2.125,60	2.499,90	3.500,20
900	300	1	BBN012269012100.	1.498,70	1.762,30	2.467,70
900	300	2	BBN012269022100.	2.429,30	2.857,20	4.001,50
900	400	1	BBN012289012100.	1.800,70	2.117,90	2.966,50
900	400	2	BBN012289022100.	2.891,10	3.400,90	4.762,20
1000	250	1	BBN012241012100.	1.395,60	1.641,50	2.297,40
1000	250	2	BBN012241022100.	2.281,30	2.684,00	3.757,00
1000	300	1	BBN012261012100.	1.601,80	1.884,20	2.637,10
1000	300	2	BBN012261022100.	2.599,50	3.058,40	4.282,10
1000	400	1	BBN012281012100.	1.912,50	2.250,00	3.150,40
1000	400	2	BBN012281022100.	3.075,80	3.618,80	5.066,50

LINGO SHELVING SYSTEM

DOUBLE-SIDED - WOODEN BACK PANEL - CASTOR PLATE - WITH OVERLAYING WOODEN TOP PLATE

Painted and veneered Lingo Shelving Systems are FSC-certified.

H920 mm

Module mm	Shelf depth mm	No. of bays	Item no.	Melamine EUR	Painted EUR	Veneer EUR
500	250	1	BBN012345012100.	1.044,80	1.228,90	1.720,70
500	250	2	BBN012345022100.	1.683,70	1.981,10	2.774,40
500	250	3	BBN012345032100.	2.407,20	2.832,00	3.965,80
500	300	1	BBN012365012100.	1.241,10	1.460,60	2.045,90
500	300	2	BBN012365022100.	1.984,80	2.336,00	3.271,10
500	300	3	BBN012365032100.	2.821,60	3.320,10	4.649,50
500	400	1	BBN012385012100.	1.572,60	1.849,60	2.589,60
500	400	2	BBN012385022100.	2.486,70	2.925,40	4.095,80
500	400	3	BBN012385032100.	3.503,60	4.121,20	5.770,80
750	250	1	BBN012347012100.	1.328,60	1.563,40	2.188,60
750	250	2	BBN012347022100.	2.169,40	2.551,80	3.572,30
750	250	3	BBN012347032100.	3.134,70	3.687,50	5.162,60
750	300	1	BBN012367012100.	1.550,10	1.823,70	2.553,20
750	300	2	BBN012367022100.	2.509,00	2.951,80	4.132,90
750	300	3	BBN012367032100.	3.607,80	4.244,30	5.943,00
750	400	1	BBN012387012100.	1.904,80	2.240,40	3.136,60
750	400	2	BBN012387022100.	3.049,50	3.586,80	5.021,90
750	400	3	BBN012387032100.	4.347,50	5.114,00	7.159,20
900	250	1	BBN012349012100.	1.460,30	1.718,60	2.405,10
900	250	2	BBN012349022100.	2.392,20	2.814,30	3.940,00
900	300	1	BBN012369012100.	1.690,60	1.988,90	2.784,20
900	300	2	BBN012369022100.	2.745,10	3.230,10	4.522,30
900	400	1	BBN012389012100.	2.054,00	2.415,90	3.383,00
900	400	2	BBN012389022100.	3.299,00	3.880,90	5.433,00
1000	250	1	BBN012341012100.	1.558,40	1.833,00	2.565,30
1000	250	2	BBN012341022100.	2.555,30	3.006,20	4.207,60
1000	300	1	BBN012361012100.	1.797,40	2.114,70	2.959,00
1000	300	2	BBN012361022100.	2.922,70	3.439,10	4.813,70
1000	400	1	BBN012381012100.	2.169,50	2.551,90	3.572,30
1000	400	2	BBN012381022100.	3.491,10	4.106,60	5.748,10

LINGO SHELVING SYSTEM

DOUBLE-SIDED - WOODEN BACK PANEL - CASTOR PLATE - WITH OVERLAYING WOODEN TOP PLATE

Painted and veneered Lingo Shelving Systems are FSC-certified.

H1220 mm

Module mm	Shelf depth mm	No. of bays	Item no.	Melamine EUR	Painted EUR	Veneer EUR
500	250	1	BBN012445012100.	1.242,50	1.461,80	2.047,10
500	250	2	BBN012445022100.	2.003,10	2.357,40	3.301,60
500	250	3	BBN012445032100.	2.848,30	3.351,70	4.693,80
500	300	1	BBN012465012100.	1.474,00	1.734,30	2.429,70
500	300	2	BBN012465022100.	2.357,00	2.773,50	3.884,40
500	300	3	BBN012465032100.	3.333,10	3.921,40	5.492,30
500	400	1	BBN012485012100.	1.890,70	2.224,50	3.115,00
500	400	2	BBN012485022100.	2.986,70	3.514,70	4.921,50
500	400	3	BBN012485032100.	4.185,50	4.924,90	6.896,80
750	250	1	BBN012447012100.	1.549,60	1.823,50	2.552,90
750	250	2	BBN012447022100.	2.535,40	2.982,50	4.175,30
750	250	3	BBN012447032100.	3.645,70	4.288,80	6.004,30
750	300	1	BBN012467012100.	1.806,30	2.124,60	2.974,90
750	300	2	BBN012467022100.	2.927,80	3.443,70	4.822,00
750	300	3	BBN012467032100.	4.189,20	4.927,20	6.899,50
750	400	1	BBN012487012100.	2.246,20	2.642,50	3.699,90
750	400	2	BBN012487022100.	3.596,10	4.230,50	5.923,40
750	400	3	BBN012487032100.	5.099,30	5.999,30	8.398,90
900	250	1	BBN012449012100.	1.686,50	1.984,80	2.778,80
900	250	2	BBN012449022100.	2.768,60	3.257,20	4.561,80
900	300	1	BBN012469012100.	1.952,00	2.295,90	3.215,30
900	300	2	BBN012469022100.	3.174,30	3.734,20	5.230,20
900	400	1	BBN012489012100.	2.400,60	2.824,10	3.955,70
900	400	2	BBN012489022100.	3.856,00	4.536,80	6.353,30
1000	250	1	BBN012441012100.	1.801,80	2.119,50	2.967,20
1000	250	2	BBN012441022100.	2.966,10	3.489,70	4.885,80
1000	300	1	BBN012461012100.	2.076,00	2.442,00	3.418,30
1000	300	2	BBN012461022100.	3.386,30	3.983,80	5.578,00
1000	400	1	BBN012481012100.	2.533,30	2.980,40	4.173,20
1000	400	2	BBN012481022100.	4.082,50	4.803,10	6.724,80

LINGO SHELVING SYSTEM

DOUBLE-SIDED - WOODEN BACK PANEL - CASTOR PLATE - WITH OVERLAYING WOODEN TOP PLATE

Painted and veneered Lingo Shelving Systems are FSC-certified.

H1520 mm

Module mm	Shelf depth mm	No. of bays	Item no.	Melamine EUR	Painted EUR	Veneer EUR
500	250	1	BBN012545012100.	1.356,90	1.595,70	2.233,50
500	250	2	BBN012545022100.	2.195,20	2.582,20	3.614,80
500	250	3	BBN012545032100.	3.118,10	3.667,40	5.133,80
500	300	1	BBN012565012100.	1.558,40	1.833,40	2.568,50
500	300	2	BBN012565022100.	2.504,10	2.946,10	4.126,20
500	300	3	BBN012565032100.	3.542,90	4.167,50	5.837,10
500	400	1	BBN012585012100.	1.993,90	2.345,80	3.284,20
500	400	2	BBN012585022100.	3.162,00	3.720,60	5.208,90
500	400	3	BBN012585032100.	4.432,90	5.215,40	7.302,40
750	250	1	BBN012547012100.	1.683,90	1.981,40	2.772,90
750	250	2	BBN012547022100.	2.767,30	3.255,30	4.555,70
750	250	3	BBN012547032100.	3.975,20	4.676,50	6.545,10
750	300	1	BBN012567012100.	1.910,60	2.247,70	3.147,30
750	300	2	BBN012567022100.	3.114,70	3.664,30	5.131,00
750	300	3	BBN012567032100.	4.458,70	5.245,30	7.345,10
750	400	1	BBN012587012100.	2.369,30	2.787,80	3.902,70
750	400	2	BBN012587022100.	3.811,20	4.484,40	6.278,00
750	400	3	BBN012587032100.	5.406,40	6.361,80	8.905,30
900	250	1	BBN012549012100.	1.838,90	2.163,80	3.028,30
900	250	2	BBN012549022100.	3.036,70	3.572,20	5.001,20
900	300	1	BBN012569012100.	2.074,40	2.440,10	3.417,20
900	300	2	BBN012569022100.	3.397,40	3.997,00	5.598,20
900	400	1	BBN012589012100.	2.541,80	2.990,50	4.188,00
900	400	2	BBN012589022100.	4.107,30	4.832,90	6.766,90
1000	250	1	BBN012541012100.	1.957,70	2.302,80	3.222,20
1000	250	2	BBN012541022100.	3.241,20	3.813,30	5.336,20
1000	300	1	BBN012561012100.	2.201,90	2.590,50	3.625,70
1000	300	2	BBN012561022100.	3.616,40	4.255,20	5.957,00
1000	400	1	BBN012581012100.	2.678,00	3.151,10	4.411,00
1000	400	2	BBN012581022100.	4.340,80	5.107,80	7.149,40

LINGO SHELVING SYSTEM

BBN012 - CROSS BRACE - CASTOR PLATE - WITH OVERLAYING WOODEN TOP PLATE



LINGO SHELVING SYSTEM

BBN012 - CROSS BRACE - CASTOR PLATE - WITH OVERLAYING WOODEN TOP PLATE

Shelving system with wooden panels, cross brace, castor plate and overlaying top plate.
Middle shelf must be screwed into panels for H1520 mm.

- Prices based on steel price group 1 and wooden price group A (see Design Options pages 6-9).
- For shelves see page 144 & 166.
- For accessories see page 186.

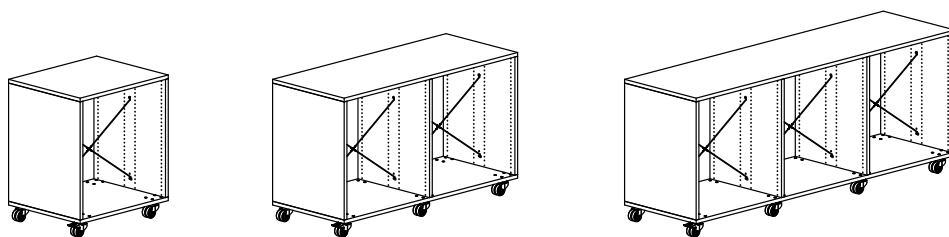

Double-sided H920 mm - 1/2/3 bays

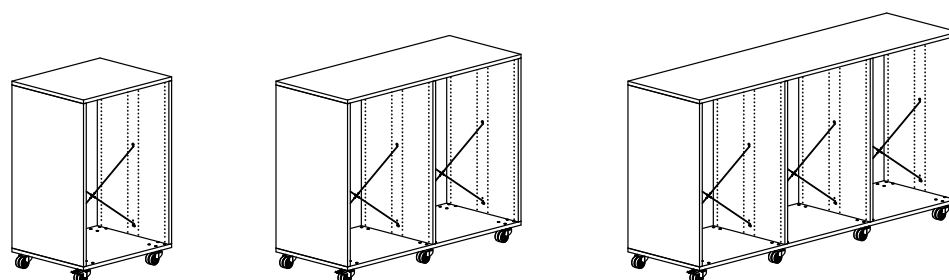

Double-sided H1220 mm - 1/2/3 bays

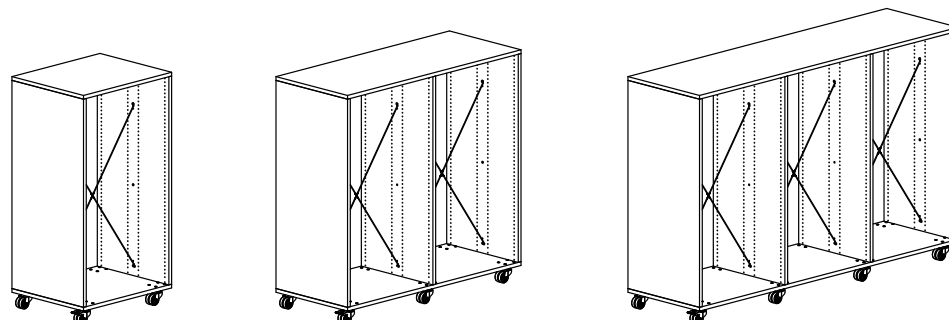

Double-sided H1520 mm - 1/2/3 bays

LINGO SHELVING SYSTEM

DOUBLE-SIDED - CROSS BRACE - CASTOR PLATE - WITH OVERLAYING WOODEN TOP PLATE

Painted and veneered Lingo Shelving Systems are FSC-certified.

H920 mm

Module mm	Shelf depth mm	No. of bays	Item no.	Melamine EUR	Painted EUR	Veneer EUR
500	250	1	BBN0123450191006	930,00	1.089,90	1.517,00
500	250	2	BBN0123450291006	1.454,10	1.703,10	2.367,00
500	250	3	BBN0123450391006	2.062,80	2.415,00	3.354,70
500	300	1	BBN0123650191006	1.126,30	1.321,60	1.842,20
500	300	2	BBN0123650291006	1.755,20	2.058,00	2.863,70
500	300	3	BBN0123650391006	2.477,20	2.903,10	4.038,40
500	400	1	BBN0123850191006	1.457,80	1.710,60	2.385,90
500	400	2	BBN0123850291006	2.257,10	2.647,40	3.688,40
500	400	3	BBN0123850391006	3.159,20	3.704,20	5.159,70
750	250	1	BBN0123470191006	1.145,40	1.344,10	1.872,70
750	250	2	BBN0123470291006	1.803,00	2.113,20	2.940,50
750	250	3	BBN0123470391006	2.585,10	3.029,60	4.214,90
750	300	1	BBN0123670191006	1.366,90	1.604,40	2.237,30
750	300	2	BBN0123670291006	2.142,60	2.513,20	3.501,10
750	300	3	BBN0123670391006	3.058,20	3.586,40	4.995,30
750	400	1	BBN0123870191006	1.721,60	2.021,10	2.820,70
750	400	2	BBN0123870291006	2.683,10	3.148,20	4.390,10
750	400	3	BBN0123870391006	3.797,90	4.456,10	6.211,50
900	250	1	BBN0123490191006	1.225,90	1.438,90	2.004,80
900	250	2	BBN0123490291006	1.923,40	2.254,90	3.139,40
900	300	1	BBN0123690191006	1.456,20	1.709,20	2.383,90
900	300	2	BBN0123690291006	2.276,30	2.670,70	3.721,70
900	400	1	BBN0123890191006	1.819,60	2.136,20	2.982,70
900	400	2	BBN0123890291006	2.830,20	3.321,50	4.632,40
1000	250	1	BBN0123410191006	1.307,00	1.533,40	2.137,70
1000	250	2	BBN0123410291006	2.052,50	2.407,00	3.352,40
1000	300	1	BBN0123610191006	1.546,00	1.815,10	2.531,40
1000	300	2	BBN0123610291006	2.419,90	2.839,90	3.958,50
1000	400	1	BBN0123810191006	1.918,10	2.252,30	3.144,70
1000	400	2	BBN0123810291006	2.988,30	3.507,40	4.892,90

LINGO SHELVING SYSTEM

DOUBLE-SIDED - CROSS BRACE - CASTOR PLATE - WITH OVERLAYING WOODEN TOP PLATE

Painted and veneered Lingo Shelving Systems are FSC-certified.

H1220 mm

Module mm	Shelf depth mm	No. of bays	Item no.	Melamine EUR	Painted EUR	Veneer EUR
500	250	1	BBN0124450191006	1.082,00	1.268,90	1.768,20
500	250	2	BBN0124450291006	1.682,10	1.971,60	2.743,80
500	250	3	BBN0124450391006	2.366,80	2.773,00	3.857,10
500	300	1	BBN0124650191006	1.313,50	1.541,40	2.150,80
500	300	2	BBN0124650291006	2.036,00	2.387,70	3.326,60
500	300	3	BBN0124650391006	2.851,60	3.342,70	4.655,60
500	400	1	BBN0124850191006	1.730,20	2.031,60	2.836,10
500	400	2	BBN0124850291006	2.665,70	3.128,90	4.363,70
500	400	3	BBN0124850391006	3.704,00	4.346,20	6.060,10
750	250	1	BBN0124470191006	1.297,40	1.523,10	2.123,90
750	250	2	BBN0124470291006	2.031,00	2.381,70	3.317,30
750	250	3	BBN0124470391006	2.889,10	3.387,60	4.717,30
750	300	1	BBN0124670191006	1.554,10	1.824,20	2.545,90
750	300	2	BBN0124670291006	2.423,40	2.842,90	3.964,00
750	300	3	BBN0124670391006	3.432,60	4.026,00	5.612,50
750	400	1	BBN0124870191006	1.994,00	2.342,10	3.270,90
750	400	2	BBN0124870291006	3.091,70	3.629,70	5.065,40
750	400	3	BBN0124870391006	4.342,70	5.098,10	7.111,90
900	250	1	BBN0124490191006	1.377,90	1.617,90	2.256,00
900	250	2	BBN0124490291006	2.151,40	2.523,40	3.516,20
900	300	1	BBN0124690191006	1.643,40	1.929,00	2.692,50
900	300	2	BBN0124690291006	2.557,10	3.000,40	4.184,60
900	400	1	BBN0124890191006	2.092,00	2.457,20	3.432,90
900	400	2	BBN0124890291006	3.238,80	3.803,00	5.307,70
1000	250	1	BBN0124410191006	1.459,00	1.712,40	2.388,90
1000	250	2	BBN0124410291006	2.280,50	2.675,50	3.729,20
1000	300	1	BBN0124610191006	1.733,20	2.034,90	2.840,00
1000	300	2	BBN0124610291006	2.700,70	3.169,60	4.421,40
1000	400	1	BBN0124810191006	2.190,50	2.573,30	3.594,90
1000	400	2	BBN0124810291006	3.396,90	3.988,90	5.568,20

LINGO SHELVING SYSTEM

DOUBLE-SIDED - CROSS BRACE - CASTOR PLATE - WITH OVERLAYING WOODEN TOP PLATE

Painted and veneered Lingo Shelving Systems are FSC-certified.

H1520 mm

Module mm	Shelf depth mm	No. of bays	Item no.	Melamine EUR	Painted EUR	Veneer EUR
500	250	1	BBN0125450191006	1.155,40	1.354,90	1.887,40
500	250	2	BBN0125450291006	1.792,20	2.100,60	2.922,60
500	250	3	BBN0125450391006	2.513,60	2.945,00	4.095,50
500	300	1	BBN0125650191006	1.356,90	1.592,60	2.222,40
500	300	2	BBN0125650291006	2.101,10	2.464,50	3.434,00
500	300	3	BBN0125650391006	2.938,40	3.445,10	4.798,80
500	400	1	BBN0125850191006	1.792,40	2.105,00	2.938,10
500	400	2	BBN0125850291006	2.759,00	3.239,00	4.516,70
500	400	3	BBN0125850391006	3.828,40	4.493,00	6.264,10
750	250	1	BBN0125470191006	1.370,80	1.609,10	2.243,10
750	250	2	BBN0125470291006	2.141,10	2.510,70	3.496,10
750	250	3	BBN0125470391006	3.035,90	3.559,60	4.955,70
750	300	1	BBN0125670191006	1.597,50	1.875,40	2.617,50
750	300	2	BBN0125670291006	2.488,50	2.919,70	4.071,40
750	300	3	BBN0125670391006	3.519,40	4.128,40	5.755,70
750	400	1	BBN0125870191006	2.056,20	2.415,50	3.372,90
750	400	2	BBN0125870291006	3.185,00	3.739,80	5.218,40
750	400	3	BBN0125870391006	4.467,10	5.244,90	7.315,90
900	250	1	BBN0125490191006	1.451,30	1.703,90	2.375,20
900	250	2	BBN0125490291006	2.261,50	2.652,40	3.695,00
900	300	1	BBN0125690191006	1.686,80	1.980,20	2.764,10
900	300	2	BBN0125690291006	2.622,20	3.077,20	4.292,00
900	400	1	BBN0125890191006	2.154,20	2.530,60	3.534,90
900	400	2	BBN0125890291006	3.332,10	3.913,10	5.460,70
1000	250	1	BBN0125410191006	1.532,40	1.798,40	2.508,10
1000	250	2	BBN0125410291006	2.390,60	2.804,50	3.908,00
1000	300	1	BBN0125610191006	1.776,60	2.086,10	2.911,60
1000	300	2	BBN0125610291006	2.765,80	3.246,40	4.528,80
1000	400	1	BBN0125810191006	2.252,70	2.646,70	3.696,90
1000	400	2	BBN0125810291006	3.490,20	4.099,00	5.721,20



LINGO SQUARE



LINGO SQUARE

WITH PLINTH

Lingo Square can be used in different environments for display, storage and exhibition. The top plate (also available in laminate) can also serve as a worktable, display or a play area. Each configuration consists of end panels, back panels, top and bottom plate, plinth and fittings. Painted and veneered Lingo Squares are FSC-certified. For shelves see from page 144, for accessories see from page 186.

H920 (939 mm) - for 2 shelves

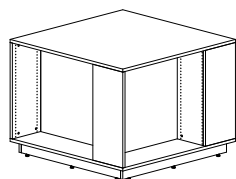

Module mm	Shelf depth mm	Total width mm	Item no.	Melamine EUR	Painted EUR	Veneer EUR
500	250	811	BBN130352200.	1.921,40	2.259,50	3.162,60
500	300	861	BBN130353200.	2.067,70	2.431,80	3.403,80
750	250	1061	BBN130372200.	2.580,20	3.034,40	4.247,90
750	300	1111	BBN130373200.	2.755,50	3.240,90	4.537,10
900	250	1211	BBN130392200.	3.019,50	3.551,30	4.972,20
900	300	1261	BBN130393200.	3.199,30	3.763,90	5.269,60

H1220 (1239 mm) - for 3 shelves

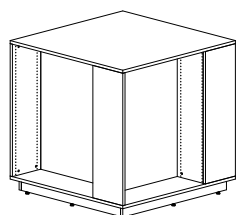

Module mm	Shelf depth mm	Total width mm	Item no.	Melamine EUR	Painted EUR	Veneer EUR
500	250	811	BBN130452200.	2.261,00	2.659,90	3.725,80
500	300	861	BBN130453200.	2.354,90	2.771,00	3.881,00
750	250	1061	BBN130472200.	2.994,60	3.522,80	4.931,90
750	300	1111	BBN130473200.	3.117,50	3.668,10	5.135,10
900	250	1211	BBN130492200.	3.452,70	4.060,50	5.685,00
900	300	1261	BBN130493200.	3.580,10	4.211,90	5.896,40

H1520 (1539 mm) - for 4 shelves

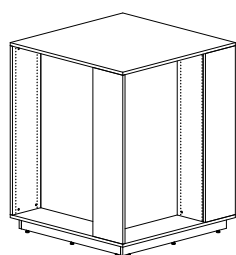

Module mm	Shelf depth mm	Total width mm	Item no.	Melamine EUR	Painted EUR	Veneer EUR
500	250	811	BBN130552200.	2.503,00	2.944,30	4.122,60
500	300	861	BBN130553200.	2.595,30	3.052,60	4.273,80
750	250	1061	BBN130572200.	3.300,20	3.881,60	5.435,50
750	300	1111	BBN130573200.	3.421,50	4.024,10	5.634,70
900	250	1211	BBN130592200.	3.815,10	4.488,50	6.284,60
900	300	1261	BBN130593200.	3.940,90	4.637,10	6.492,00

H1820 (1839 mm) - for 5 shelves

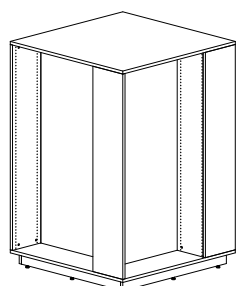

Module mm	Shelf depth mm	Total width mm	Item no.	Melamine EUR	Painted EUR	Veneer EUR
500	250	811	BBN130652200.	2.776,60	3.264,70	4.570,60
500	300	861	BBN130653200.	2.860,50	3.364,20	4.709,80
750	250	1061	BBN130672200.	3.628,60	4.268,40	5.975,10
750	300	1111	BBN130673200.	3.741,50	4.402,10	6.162,30
900	250	1211	BBN130692200.	4.205,90	4.947,30	6.927,00
900	300	1261	BBN130693200.	4.323,30	5.087,10	7.122,40

LINGO SQUARE



LINGO SQUARE

WITH CASTORS

Lingo Square can be used in different environments for display, storage and exhibition. The top plate (available in laminate) can also serve as a worktable, display or a play area. Each configuration consists of end panels, back panels, top and bottom plate, 8 castors (Ø75 mm, 2 with brakes) and fittings. Painted and veneered Lingo Squares are FSC-certified. For shelves see from page 144, for accessories see from page 186.

H920 (939 mm) - for 2 shelves

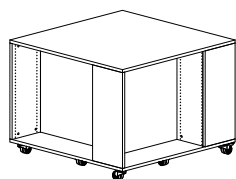

Module mm	Shelf depth mm	Total width mm	Item no.	Melamine EUR	Painted EUR	Veneer EUR
500	250	811	BBN130352100.	1.777,90	2.091,00	2.926,30
500	300	861	BBN130353100.	1.915,90	2.253,20	3.153,70
750	250	1061	BBN130372100.	2.364,90	2.781,10	3.893,10
750	300	1111	BBN130373100.	2.528,10	2.973,40	4.162,90
900	250	1211	BBN130392100.	2.767,20	3.254,50	4.556,60
900	300	1261	BBN130393100.	2.934,50	3.452,20	4.832,90

H1220 (1239 mm) - for 3 shelves

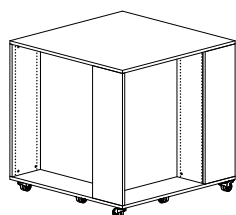

Module mm	Shelf depth mm	Total width mm	Item no.	Melamine EUR	Painted EUR	Veneer EUR
500	250	811	BBN130452100.	2.117,50	2.491,40	3.489,50
500	300	861	BBN130453100.	2.203,10	2.592,40	3.630,90
750	250	1061	BBN130472100.	2.779,30	3.269,50	4.577,10
750	300	1111	BBN130473100.	2.890,10	3.400,60	4.760,90
900	250	1211	BBN130492100.	3.200,40	3.763,70	5.269,40
900	300	1261	BBN130493100.	3.315,30	3.900,20	5.459,70

H1520 (1539 mm) - for 4 shelves

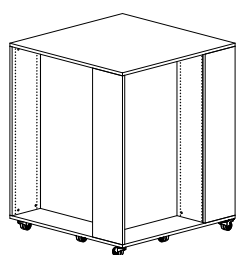

Module mm	Shelf depth mm	Total width mm	Item no.	Melamine EUR	Painted EUR	Veneer EUR
500	250	811	BBN130552100.	2.359,50	2.775,80	3.886,30
500	300	861	BBN130553100.	2.443,50	2.874,00	4.023,70
750	250	1061	BBN130572100.	3.084,90	3.628,30	5.080,70
750	300	1111	BBN130573100.	3.194,10	3.756,60	5.260,50
900	250	1211	BBN130592100.	3.562,80	4.191,70	5.869,00
900	300	1261	BBN130593100.	3.676,10	4.325,40	6.055,30

H1820 (1839 mm) - for 5 shelves

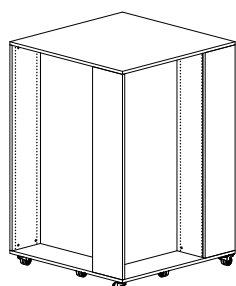

Module mm	Shelf depth mm	Total width mm	Item no.	Melamine EUR	Painted EUR	Veneer EUR
500	250	811	BBN130652100.	2.633,10	3.096,20	4.334,30
500	300	861	BBN130653100.	2.708,70	3.185,60	4.459,70
750	250	1061	BBN130672100.	3.413,30	4.015,10	5.620,30
750	300	1111	BBN130673100.	3.514,10	4.134,60	5.788,10
900	250	1211	BBN130692100.	3.953,60	4.650,50	6.511,40
900	300	1261	BBN130693100.	4.058,50	4.775,40	6.685,70



COMPONENTS

CHECK LIST

When constructing your shelving, there are many factors to be taken into consideration and most importantly, you must remember to order all parts. Below you will find a check list of components you need to consider when constructing your wooden shelving.

SHELVES

The following factors are all to be considered before choosing the shelf:

- steel or wooden shelf
- hanging or backedge book support
- max. weight
- type of fixture
- steel/wooden topshelf or wooden overlaying top plate

ACCESSORIES

- Supply or exchange a shelf with a function; e.g. a browser or multimedia storage.

CASTORS

Extra components to complete the function and design of shelving:

- castor frame with castors
- castor plate with castors
- plinth

PANELS

The following factors are all to be considered before choosing the panel:

- design (standard/slat - slat is only available for double-sided shelving H1520-2120 MM)
- volume (single-sided/double-sided)
- height (720/920/1220/1520/1820/2120 mm)
- depth (250/300/400 mm)
- stationary or mobile (adjustable feet/castor frame/castor plate)
- top (top shelf/overlaying top plate)

CONNECTION ELEMENTS

To support the shelving and determine the design of shelving system, you must choose between one of the 3 connection elements:

- steel back frame
- wooden back panel
- galvanized cross brace

SHELVES

S1 & S2 - STEEL SHELVES

See below for overview of standard steel shelves:

S1 - STEEL SHELF WITH STEEL BACKEDGE - FOR BACKEDGE BOOK SUPPORT

Details:

- Module 500/750/900/1000 mm
- Depth 250/300/400 mm
- Steel backedge H47 mm
- Backedge book support
- Steel brackets
- Max. weight 80 kg.
- Straight, 45°/60° sloping & 7,5° reverse tilted

Use with:

- ST1 - steel top shelf
- WT1 - wooden top shelf
- WO1 - wooden overlaying top plate

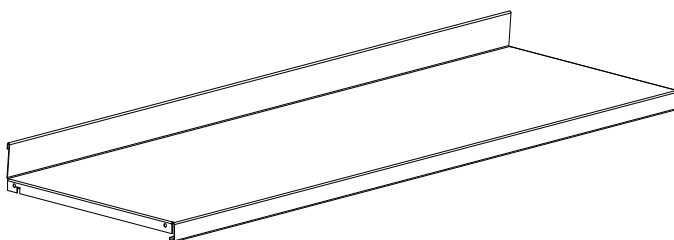

Note:

- Steel shelves placed at the bottom, must always be fixed with screws.
- Shelving H1820 and 2120 with cross brace must always have one intermediate steel shelf fixed with screws.

S2 - STEEL SHELF WITH ACRYLIC BACKEDGE - FOR HANGING BOOK SUPPORT

Details:

- Module 500/750/900/1000 mm
- Depth 250/300/400 mm
- Acrylic backedge H17 mm (loose part)
- Hanging book support
- Steel brackets
- Max. weight 80 kg.
- Straight, 45°/60° sloping & 7,5° reverse tilted

Use with:

- ST2 - steel top shelf
- WT1 - wooden top shelf
- WO1 - wooden overlaying top plate

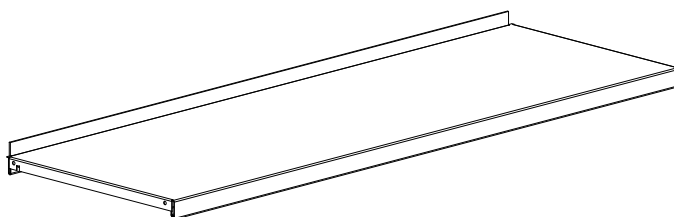

Note:

- Steel shelves placed at the bottom, must always be fixed with screws.
- Shelving H1820 and 2120 with cross brace must always have one intermediate steel shelf fixed with screws.

SHELVES

S3 & S4 - STEEL SHELVES

See below for overview of standard steel shelves:

S3 - STEEL SHELF WITH STEEL BACKEDGE - FOR HANGING BOOK SUPPORT

Details:

- Module 500/750/900/1000 mm
- Depth 250/300/400 mm
- Steel backedge H25 mm
- Hanging book support
- Pins/screws
- Max. weight 80 kg.
- Straight and sloping

Use with:

- ST3 - steel top shelf
- WT1 - wooden top shelf
- WO1 - wooden overlaying top plate

Note:

- Steel shelves placed at the bottom, must always be fixed with screws.
- Shelving H1820 and 2120 with cross brace must always have one intermediate steel shelf fixed with screws.

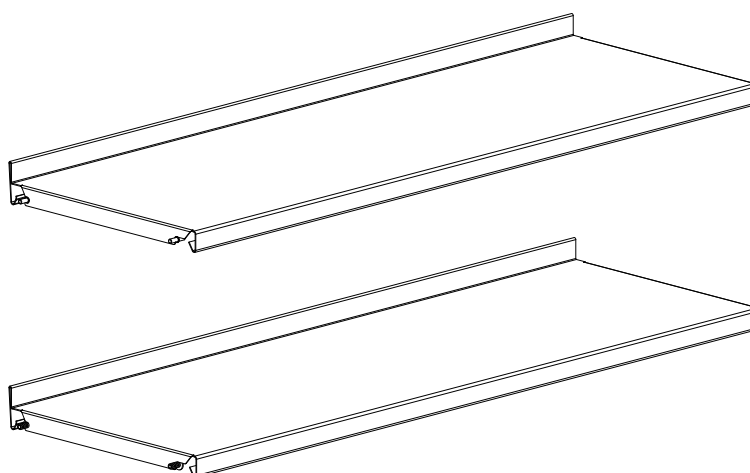

S4 - STEEL SHELF WITH NO BACKEDGE - FOR HANGING BOOK SUPPORT

Details:

- Module 500/750/900/1000 mm
- Depth 250/300/400 mm
- No backedge
- Hanging book support
- Pins/screws
(use screws for cross brace H1820 og 2120 mm)
- Max. weight 80 kg.
- Straight

Use with:

- ST3 - steel top shelf
- WT1 - wooden top shelf
- WO1 - wooden overlaying top plate
-

Note:

- Steel shelves placed at the bottom, must always be fixed with screws.
- Shelving H1820 and 2120 with cross brace must always have one intermediate steel shelf fixed with screws.

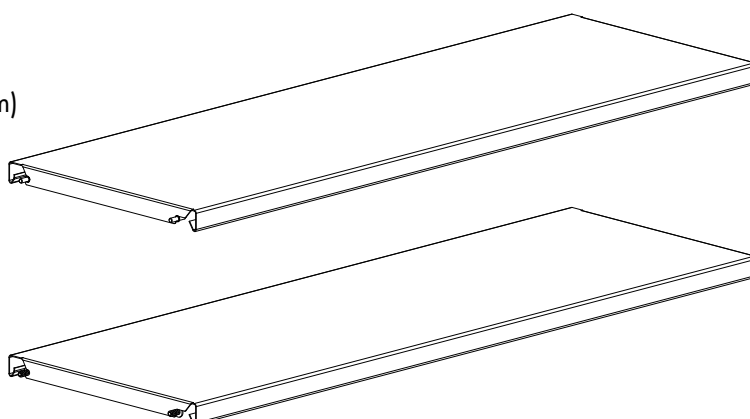

SHELVES

S1 - STEEL SHELF & COMPONENTS

S1 - Steel shelf with steel backedge and steel brackets - for backedge book support

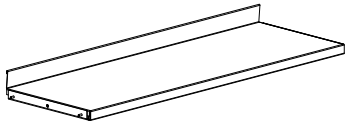
Steel backedge 47 mm.	Module mm	Shelf depth mm	Item no.	Price EUR
	500	250	BBN0901152	77,10
	500	300	BBN0901153	80,90
	500	400	BBN0901154	93,50
	750	250	BBN0901172	77,10
	750	300	BBN0901173	80,90
	750	400	BBN0901174	93,50
	900	250	BBN0901192	80,70
	900	300	BBN0901193	86,20
	900	400	BBN0901194	106,80
	1000	250	BBN0901112	88,60
	1000	300	BBN0901113	93,10
	1000	400	BBN0901114	110,10

S1 - Steel shelf with steel frontedge and 45°/60° steel plate brackets

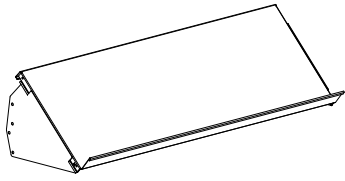
Steel frontedge 47 mm.	Module mm	Shelf depth mm	Item no.	Price EUR
	500	250	BBN0901352	122,90
	500	300	BBN0901353	126,70
	500	400	BBN0901354	139,30
	750	250	BBN0901372	122,90
	750	300	BBN0901373	126,70
	750	400	BBN0901374	139,30
	900	250	BBN0901392	126,50
	900	300	BBN0901393	132,00
	900	400	BBN0901394	152,60
	1000	250	BBN0901312	134,40
	1000	300	BBN0901313	138,90
	1000	400	BBN0901314	155,90

S1 - Steel shelf with steel backedge and 7.5° reverse tilted steel plate brackets - for backedge book support

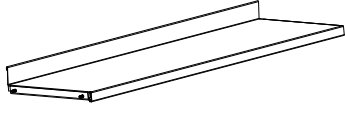
Steel backedge 47 mm.	Module mm	Shelf depth mm	Item no.	Price EUR
	500	250	BBN0901252	89,50
	500	300	BBN0901253	98,30
	500	400	BBN0901254	116,90
	750	250	BBN0901272	89,50
	750	300	BBN0901273	98,30
	750	400	BBN0901274	116,90
	900	250	BBN0901292	93,10
	900	300	BBN0901293	103,60
	900	400	BBN0901294	130,20
	1000	250	BBN0901212	101,00
	1000	300	BBN0901213	110,50
	1000	400	BBN0901214	133,50

SHELVES

S1 - STEEL SHELF & COMPONENTS

S1 - Steel shelf with steel backedge - for backedge book support

Steel backedge 47 mm.
Brackets to be ordered separately, see page 150.

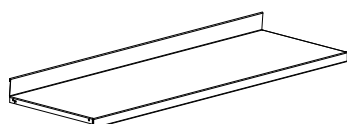

Module mm	Shelf depth mm	Item no.	Price EUR
500	250	B40110525	59,10
500	300	B40110535	62,90
500	400	B40110545	75,50
750	250	B40100127	59,10
750	300	B40100137	62,90
750	400	B40100147	75,50
900	250	B40100129	62,70
900	300	B40100139	68,20
900	400	B40100149	88,80
1000	250	B40100121	70,60
1000	300	B40100131	75,10
1000	400	B40100141	92,10

Backedge book support - for S1

Nickel plated steel, Ø6 mm,
with a nylon glider.

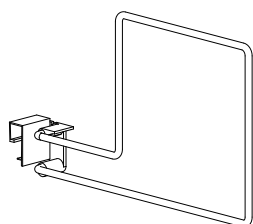

Shelf depth mm	Books left/right of book support	Item no.	Price EUR
250	Left	B4011221	18,90
300	Left	B4011222	20,40
250/300	Left (high)	B4011223	26,50
250	Right	B4011224	18,90
300	Right	B4011225	20,40

SHELVES

S2 - STEEL SHELF

S2 - Steel shelf with acrylic backedge and steel brackets - for hanging book support

Acrylic backedge 17 mm.
Note: Spot welding visible on top of surface.

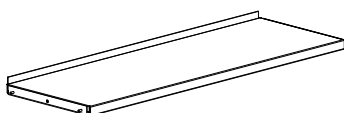

Module mm	Shelf depth mm	Item no.	Price EUR
500	250	BBN0902152	61,30
500	300	BBN0902153	66,60
500	400	BBN0902154	99,30
750	250	BBN0902172	61,30
750	300	BBN0902173	66,60
750	400	BBN0902174	99,30
900	250	BBN0902192	61,30
900	300	BBN0902193	66,60
900	400	BBN0902194	99,30
1000	250	BBN0902112	66,10
1000	300	BBN0902113	72,80
1000	400	BBN0902114	109,20

S2 - Steel shelf with acrylic backedge and 45°/60° steel plate brackets

Acrylic backedge 17 mm.

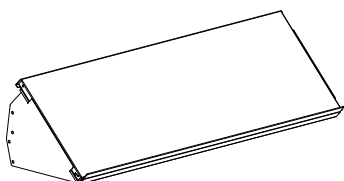

Module mm	Shelf depth mm	Item no.	Price EUR
500	250	BBN0902352	107,10
500	300	BBN0902353	112,40
500	400	BBN0902354	145,10
750	250	BBN0902372	107,10
750	300	BBN0902373	112,40
750	400	BBN0902374	145,10
900	250	BBN0902392	107,10
900	300	BBN0902393	112,40
900	400	BBN0902394	145,10
1000	250	BBN0902312	111,90
1000	300	BBN0902313	118,60
1000	400	BBN0902314	155,00

S2 - Steel shelf with acrylic backedge and 7.5° reverse tilted steel plate brackets

Acrylic backedge 17 mm.

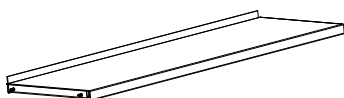

Module mm	Shelf depth mm	Item no.	Price EUR
500	250	BBN0902252	73,70
500	300	BBN0902253	84,00
500	400	BBN0902254	122,70
750	250	BBN0902272	73,70
750	300	BBN0902273	84,00
750	400	BBN0902274	122,70
900	250	BBN0902292	73,70
900	300	BBN0902293	84,00
900	400	BBN0902294	122,70
1000	250	BBN0902212	78,50
1000	300	BBN0902213	90,20
1000	400	BBN0902214	132,60

SHELVES

S2 - STEEL SHELF & COMPONENTS

S2 - Steel shelf with acrylic backedge - for hanging book support

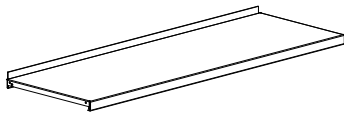
Acrylic backedge 17 mm. Brackets to be ordered separately, see page 150. Note: Spot welding visible on top of surface.	Module mm	Shelf depth mm	Item no.	Price EUR
	500	250	B401106251	43,30
	500	300	B401106351	48,60
	500	400	B401106451	81,30
	750	250	B40101327	43,30
	750	300	B40101337	48,60
	750	400	B40101347	81,30
	900	250	B40101329	43,30
	900	300	B40101339	48,60
	900	400	B40101349	81,30
	1000	250	B40101321	48,10
	1000	300	B40101331	54,80
	1000	400	B40101341	91,20

Hanging book support - for S2

Available in chrome steel or standard steel colours.	Type	Height mm	Item no.	Price EUR
	Normal	200	B4011242	10,10
	Folio	250	B4011245	10,90

Acrylic backedge - for S2

Spare part. H40 mm, 17 mm above shelf. Included when ordering steel shelf with acrylic backedge.	Module	Item no.	Price EUR
	500	B4010145	22,00
	750	B4010127	3,90
	900	B4010129	3,90
	1000	B4010121	3,90

SHELVES

S1 & S2 - COMPONENTS

Steel bracket - for S1 & S2

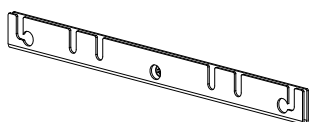

Shelf depth mm	Item no.	Price EUR
250	BN0842	9,00
300	BN0843	9,00
400	BN0844	9,00

45°/60° steel plate bracket - for S1 & S2

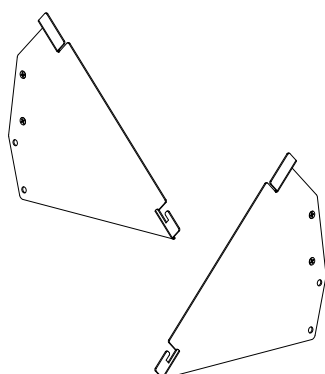

Shelf depth mm	Type	Item no.	Price EUR
250	Left	BN08828	31,90
250	Right	BN08829	31,90
300	Left	BN08838	31,90
300	Right	BN08839	31,90
400	Left	BN08848	31,90
400	Right	BN08849	31,90

7.5° reverse tilted steel plate bracket - for S1 & S2

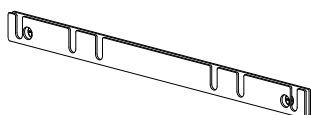

Shelf depth mm	Item no.	Price EUR
250	BN0862	15,20
300	BN0863	17,70
400	BN0864	20,70

SHELVES

S3 - STEEL SHELF

S3 - Steel shelf with steel backedge and pins - for hanging book support

Steel backedge H25 mm.
When turned, the shelf can be used as a sloping shelf by using the existing pins and bracket BN066 (see page 153).

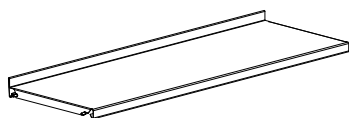

Module mm	Shelf depth mm	Item no.	Price EUR
500	250	BN0655214	37,90
500	300	BN0655314	42,50
500	400	BN0655414	71,20
750	250	BN0657214	37,90
750	300	BN0657314	42,50
750	400	BN0657414	71,20
900	250	BN0659214	37,90
900	300	BN0659314	42,50
900	400	BN0659414	71,20
1000	250	BN0651214	42,10
1000	300	BN0651314	48,00
1000	400	BN0651414	79,80

S3 - Steel shelf with steel backedge, screws and spacers - for hanging book support

Steel backedge H25 mm.

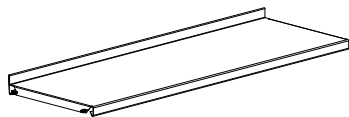

Module mm	Shelf depth mm	Item no.	Price EUR
500	250	BN0655215	37,90
500	300	BN0655315	42,50
500	400	BN0655415	71,20
750	250	BN0657215	37,90
750	300	BN0657315	42,50
750	400	BN0657415	71,20
900	250	BN0659215	37,90
900	300	BN0659315	42,50
900	400	BN0659415	71,20
1000	250	BN0651215	42,10
1000	300	BN0651315	48,00
1000	400	BN0651415	79,80

S3 - Steel shelf with steel backedge, pins and bracket for sloping shelf

Steel backedge H25 mm.

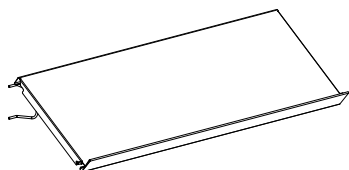

Module mm	Shelf depth mm	Item no.	Price EUR
500	250	BBN0903352	60,90
500	300	BBN0903353	65,50
500	400	BBN0903354	94,20
750	250	BBN0903372	60,90
750	300	BBN0903373	65,50
750	400	BBN0903374	94,20
900	250	BBN0903392	60,90
900	300	BBN0903393	65,50
900	400	BBN0903394	94,20
1000	250	BBN0903312	65,10
1000	300	BBN0903313	71,00
1000	400	BBN0903314	102,80

SHELVES

S3 - COMPONENTS

Hanging book support - for S3, S4 & ST3

Chromed round steel with unbreakable plastic sliders. Easy adjustable.

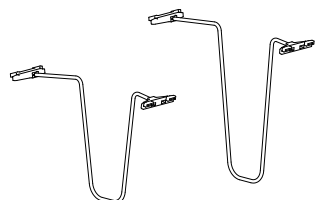

Height mm	Shelf depth mm
--------------	-------------------

220	250
220	300

280	250
280	300

Item no.	Price EUR
----------	--------------

B40553032	11,30
B40553033	12,00

B40553062	12,60
B40553063	13,60

Bracket for creating sloping shelf - for S3

Chrome round steel. The angle is adjustable, but 45° is recommended. Two brackets required per shelf.

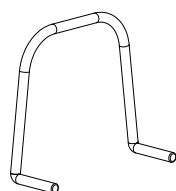

Item no.	Price EUR
----------	--------------

BN066	11,50
-------	-------

SHELVES

S4 - STEEL SHELF & COMPONENTS

S4 - Steel shelf with pins - for hanging book support

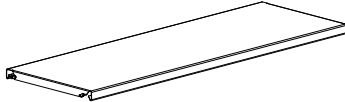
Pins incl.	Module mm	Shelf depth mm	Item no.	Price EUR
	500	250	BN0655204	33,40
	500	300	BN0655304	38,10
	500	400	BN0655404	66,90
	750	250	BN0657204	33,40
	750	300	BN0657304	38,10
	750	400	BN0657404	66,90
	900	250	BN0659204	33,40
	900	300	BN0659304	38,10
	900	400	BN0659404	66,90
	1000	250	BN0651204	37,50
	1000	300	BN0651304	43,50
	1000	400	BN0651404	75,20

S4 - Steel shelf with screws and spacer - for hanging book support

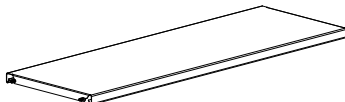
Screws incl.	Module mm	Shelf depth mm	Item no.	Price EUR
	500	250	BN0655205	33,40
	500	300	BN0655305	38,10
	500	400	BN0655405	66,90
	750	250	BN0657205	33,40
	750	300	BN0657305	38,10
	750	400	BN0657405	66,90
	900	250	BN0659205	33,40
	900	300	BN0659305	38,10
	900	400	BN0659405	66,90
	1000	250	BN0651205	37,50
	1000	300	BN0651305	43,50
	1000	400	BN0651405	75,20

Hanging book support - for S3, S4 & ST3

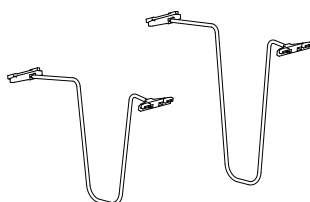
Chromed round steel with unbreakable plastic sliders. Easy adjustable.	Height mm	Shelf depth mm	Item no.	Price EUR
	220	250	B40553032	11,30
	220	300	B40553033	12,00
	280	250	B40553062	12,60
	280	300	B40553063	13,60

SHELVES

ST1 & ST2 - STEEL TOP SHELVES

Choose between a steel or wooden top shelf (placed in between the wooden panels) or an overlaying wooden overlaying top plate (placed on top of the panels).

ST1 - STEEL TOP SHELF

Details:

- Module 500/750/900/1000 mm
- Depth 250/300/400 mm
- Single-sided standard depth
- Single-sided full depth
- Double-sided
- With 25/47 mm frontedge
- Brackets and screws
- Max. weight 25 kg.

Use with:

- S1 - steel shelf for backedge book support
- WP1/2/5/6 - wooden panel
- WBP1/WBP3 - wooden back panel for ST1 standard depth
- WBP2/WBP4 - wooden back panel for ST1 full depth
- WBP2/WBP4 - wooden back panel for ST1 double-sided

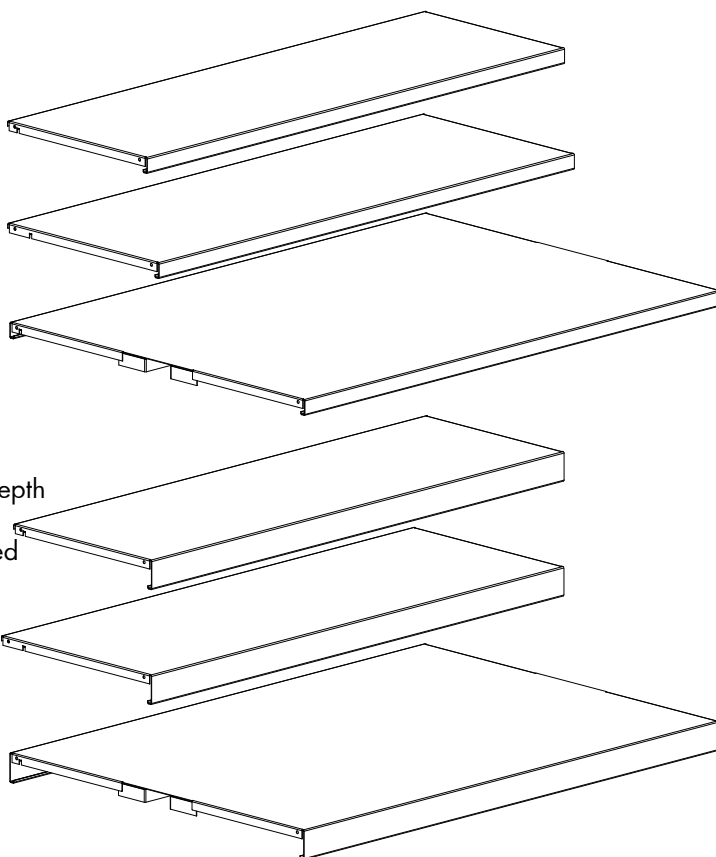

ST2 - STEEL TOP SHELF

Details:

- Module 500/750/900/1000 mm
- Depth 250/300/400 mm
- Single-sided
- With 25 mm frontedge
- Brackets and screws
- Hanging book support
- Max. weight 80 kg

Use with:

- S2 - steel shelf for hanging book support
- WP1/2/5/6 - wooden panel
- WBP1/3 - wooden back panel

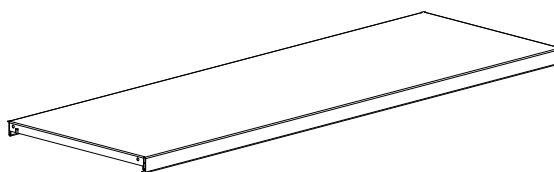

SHELVES

ST3 - STEEL SHELVES

Choose between a steel or wooden top shelf (placed in between the wooden panels) or an overlaying wooden overlaying top plate (placed on top of the panels).

ST3 - STEEL TOP SHELF

Details:

- Module 500/750/900/1000 mm
- Depth 250/300/400 mm
- Single-sided
- With 25 mm frontedge and 50 mm clip-on label holder
- Screws and spacer
- Hanging book support
- Max. weight 80 kg.

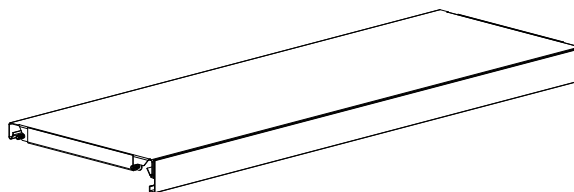

Use with:

- S3 - steel shelf - for hanging book support
- WP1/2/5/6 - wooden panel
- WBP1/3 - wooden back panel

SHELVES

ST1 - STEEL TOP SHELF WITH H25 MM FRONTEDGE AND BRACKETS

ST1 - Single-sided steel top shelf with H25 mm frontedge and brackets - standard depth

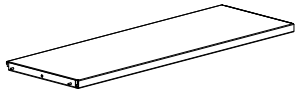
To be used with S1.	Module mm	Shelf depth mm	Item no.	Price EUR
	500	250	BBN086152	105,60
	500	300	BBN086153	110,00
	500	400	BBN086154	118,60
	750	250	BBN086172	105,60
	750	300	BBN086173	110,00
	750	400	BBN086174	118,60
	900	250	BBN086192	110,30
	900	300	BBN086193	113,10
	900	400	BBN086194	128,00
	1000	250	BBN086112	116,90
	1000	300	BBN086113	121,80
	1000	400	BBN086114	134,10

ST1 - Single-sided steel top shelf with H25 mm frontedge and brackets - full depth

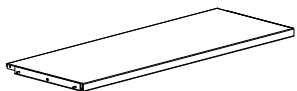
To be used with S1. Only for single-sided shelving.	Module mm	Shelf depth mm	Item no.	Price EUR
	500	250	BBN086352	105,60
	500	300	BBN086353	110,00
	500	400	BBN086354	118,60
	750	250	BBN086372	105,60
	750	300	BBN086373	110,00
	750	400	BBN086374	118,60
	900	250	BBN086392	110,30
	900	300	BBN086393	113,10
	900	400	BBN086394	128,00
	1000	250	BBN086312	116,90
	1000	300	BBN086313	121,80
	1000	400	BBN086314	134,10

ST1 - Double-sided steel top shelf with H25 mm frontedge and brackets

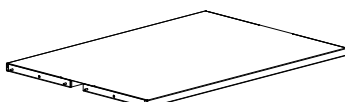
To be used with S1.	Module mm	Shelf depth mm	Item no.	Price EUR
	500	250	BBN086552	211,30
	500	300	BBN086553	220,00
	500	400	BBN086554	237,20
	750	250	BBN086572	211,30
	750	300	BBN086573	220,00
	750	400	BBN086574	237,20
	900	250	BBN086592	220,70
	900	300	BBN086593	226,30
	900	400	BBN086594	255,90
	1000	250	BBN086512	233,70
	1000	300	BBN086513	243,60
	1000	400	BBN086514	268,10

SHELVES

ST1 - STEEL TOP SHELF WITH H25 MM FRONTEDGE

ST1 - Single-sided steel top shelf with H25 mm frontedge - standard depth

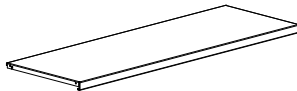
Brackets must be ordered separately. To be used with S1.	Module mm	Shelf depth mm	Item no.	Price EUR
	500	250	BN080522518	87,60
	500	300	BN080532518	92,00
	500	400	BN080542518	100,60
	750	250	BN080722518	87,60
	750	300	BN080732518	92,00
	750	400	BN080742518	100,60
	900	250	BN080922518	92,30
	900	300	BN080932518	95,10
	900	400	BN080942518	110,00
	1000	250	BN080122518	98,90
	1000	300	BN080132518	103,80
	1000	400	BN080142518	116,10

ST1 - Single-sided steel top shelf with H25 mm frontedge - full depth

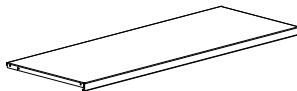
Brackets must be ordered separately. To be used with S1. Only for single-sided shelving.	Module mm	Shelf depth mm	Item no.	Price EUR
	500	250	BN080522519	87,60
	500	300	BN080532519	92,00
	500	400	BN080542519	100,60
	750	250	BN080722519	87,60
	750	300	BN080732519	92,00
	750	400	BN080742519	100,60
	900	250	BN080922519	92,30
	900	300	BN080932519	95,10
	900	400	BN080942519	110,00
	1000	250	BN080122519	98,90
	1000	300	BN080132519	103,80
	1000	400	BN080142519	116,10

ST1 - Double-sided steel top shelf with H25 mm frontedge

Brackets must be ordered separately. To be used with S1.	Module mm	Shelf depth mm	Item no.	Price EUR
	500	250	BN080522528	175,30
	500	300	BN080532528	184,00
	500	400	BN080542528	201,20
	750	250	BN080722528	175,30
	750	300	BN080732528	184,00
	750	400	BN080742528	201,20
	900	250	BN080922528	184,70
	900	300	BN080932528	190,30
	900	400	BN080942528	219,90
	1000	250	BN080122528	197,70
	1000	300	BN080132528	207,60
	1000	400	BN080142528	232,10

SHELVES

ST1 - STEEL TOP SHELF WITH H47 MM FRONTEDGE AND BRACKETS

ST1 - Single-sided steel top shelf with H47 mm frontedge and brackets - standard depth

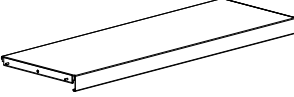
To be used with S1.	Module mm	Shelf depth mm	Item no.	Price EUR
	500	250	BBN086252	105,60
	500	300	BBN086253	110,00
	500	400	BBN086254	118,60
	750	250	BBN086272	105,60
	750	300	BBN086273	110,00
	750	400	BBN086274	118,60
	900	250	BBN086292	110,30
	900	300	BBN086293	113,10
	900	400	BBN086294	128,00
	1000	250	BBN086212	116,90
	1000	300	BBN086213	121,80
	1000	400	BBN086214	134,10

ST1 - Single-sided steel top shelf with H47 mm frontedge and brackets - full depth

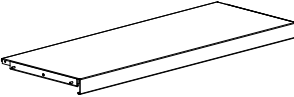
To be used with S1. Only for single-sided shelving.	Module mm	Shelf depth mm	Item no.	Price EUR
	500	250	BBN086452	105,60
	500	300	BBN086453	110,00
	500	400	BBN086454	118,60
	750	250	BBN086472	105,60
	750	300	BBN086473	110,00
	750	400	BBN086474	118,60
	900	250	BBN086492	110,30
	900	300	BBN086493	113,10
	900	400	BBN086494	128,00
	1000	250	BBN086412	116,90
	1000	300	BBN086413	121,80
	1000	400	BBN086414	134,10

ST1 - Double-sided steel top shelf with H47 mm frontedge and brackets

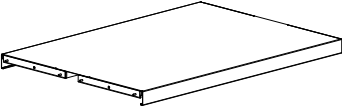
To be used with S1.	Module mm	Shelf depth mm	Item no.	Price EUR
	500	250	BBN086652	211,30
	500	300	BBN086653	220,00
	500	400	BBN086654	237,20
	750	250	BBN086672	211,30
	750	300	BBN086673	220,00
	750	400	BBN086674	237,20
	900	250	BBN086692	220,70
	900	300	BBN086693	226,30
	900	400	BBN086694	255,90
	1000	250	BBN086612	233,70
	1000	300	BBN086613	243,60
	1000	400	BBN086614	268,10

SHELVES

ST1 - STEEL TOP SHELF WITH H47 MM FRONTEDGE

ST1 - Single-sided steel top shelf with H47 mm frontedge - standard depth

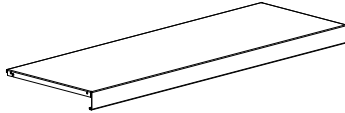
Brackets must be ordered separately. To be used with S1.	Module mm	Shelf depth mm	Item no.	Price EUR
	500	250	BN080524718	87,60
	500	300	BN080534718	92,00
	500	400	BN080544718	100,60
	750	250	BN080724718	87,60
	750	300	BN080734718	92,00
	750	400	BN080744718	100,60
	900	250	BN080924718	92,30
	900	300	BN080934718	95,10
	900	400	BN080944718	110,00
	1000	250	BN080124718	98,90
	1000	300	BN080134718	103,80
	1000	400	BN080144718	116,10

ST1 - Single-sided steel top shelf with H47 mm frontedge - full depth

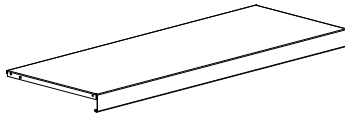
Brackets must be ordered separately. To be used with S1. Only for single-sided shelving.	Module mm	Shelf depth mm	Item no.	Price EUR
	500	250	BN080524719	87,60
	500	300	BN080534719	92,00
	500	400	BN080544719	100,60
	750	250	BN080724719	87,60
	750	300	BN080734719	92,00
	750	400	BN080744719	100,60
	900	250	BN080924719	92,30
	900	300	BN080934719	95,10
	900	400	BN080944719	110,00
	1000	250	BN080124719	98,90
	1000	300	BN080134719	103,80
	1000	400	BN080144719	116,10

ST1 - Double-sided steel top shelf with H47 mm frontedge

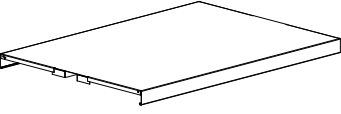
Brackets must be ordered separately. To be used with S1.	Module mm	Shelf depth mm	Item no.	Price EUR
	500	250	BN080524728	175,30
	500	300	BN080534728	184,00
	500	400	BN080544728	201,20
	750	250	BN080724728	175,30
	750	300	BN080734728	184,00
	750	400	BN080744728	201,20
	900	250	BN080924728	184,70
	900	300	BN080934728	190,30
	900	400	BN080944728	219,90
	1000	250	BN080124728	197,70
	1000	300	BN080134728	207,60
	1000	400	BN080144728	232,10

SHELVES

ST2 - STEEL TOP SHELF & COMPONENTS

ST2 - Single-sided steel top shelf with brackets - standard depth - for hanging book support

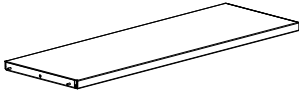
To be used with S2.	Module mm	Shelf depth mm	Item no.	Price EUR
	500	250	BBN086752	57,00
	500	300	BBN086753	62,50
	500	400	BBN086754	95,50
	750	250	BBN086772	56,30
	750	300	BBN086773	61,30
	750	400	BBN086774	99,30
	900	250	BBN086792	56,30
	900	300	BBN086793	61,30
	900	400	BBN086794	99,30
	1000	250	BBN086712	65,80
	1000	300	BBN086713	66,10
	1000	400	BBN086714	109,20

ST2 - Single-sided steel top shelf - standard depth - for hanging book support

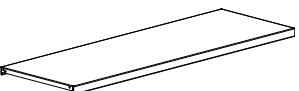
Brackets must be ordered separately. To be used with S2.	Module mm	Shelf depth mm	Item no.	Price EUR
	500	250	B401106250	39,00
	500	300	B401106350	44,50
	500	400	B401106450	77,50
	750	250	B40101127	38,30
	750	300	B40101137	43,30
	750	400	B40101147	81,30
	900	250	B40101129	38,30
	900	300	B40101139	43,30
	900	400	B40101149	81,30
	1000	250	B40101121	47,80
	1000	300	B40101131	48,10
	1000	400	B40101141	91,20

Hanging book support - for S2 & ST2

Available in chrome steel or standard steel colours.	Type	Height mm	Item no.	Price EUR
	Normal	200	B4011242	10,10
	Folio	250	B4011245	10,90

SHELVES

ST1 & ST2 - COMPONENTS

Steel bracket - for ST1 & ST2

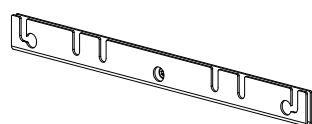

Shelf depth mm	Item no.	Price EUR
250	BN0842	9,00
300	BN0843	9,00
400	BN0844	9,00

Shelf bridge - for ST1 & ST2

Used to minimize gap between ST1/ST2 on double-sided shelving.



Shelf	Module	Item no.	Price EUR
ST1 w/25 mm front	500	BN04015	32,60
ST1 w/25 mm front	750	BN04017	32,60
ST1 w/25 mm front	900	BN04019	32,60
ST1 w/25 mm front	1000	BN04011	36,10
ST1 w/47 mm front	500	BN04025	32,60
ST1 w/47 mm front	750	BN04027	32,60
ST1 w/47 mm front	900	BN04029	32,60
ST1 w/47 mm front	1000	BN04021	36,10
ST2	500	BN04075	32,60
ST2	750	BN04077	32,60
ST2	900	BN04079	32,60
ST2	1000	BN04071	36,10

SHELVES

ST3 - STEEL TOP SHELF WITH CLIP-ON LABEL HOLDER & COMPONENTS

ST3 - Single-sided steel top shelf with screws, spacer and clip on label holder - for hanging book support

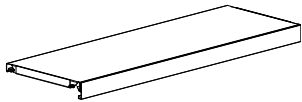
H50 mm plastic clip-on label holder. To be used with S3 and S4.	Module mm	Shelf depth mm	Item no.	Price EUR
	500	250	BBN08452	66,10
	500	300	BBN08453	70,80
	500	400	BBN08454	99,60
	750	250	BBN08472	66,10
	750	300	BBN08473	70,80
	750	400	BBN08474	99,60
	900	250	BBN08492	66,10
	900	300	BBN08493	70,80
	900	400	BBN08494	99,60
	1000	250	BBN08412	70,20
	1000	300	BBN08413	76,20
	1000	400	BBN08414	107,90

S4 - Steel shelf with screws and spacer - for hanging book support

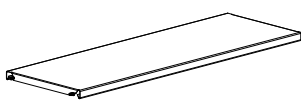
Steel shelf can be used as steel top shelf.	Module mm	Shelf depth mm	Item no.	Price EUR
	500	250	BN0655205	33,40
	500	300	BN0655305	38,10
	500	400	BN0655405	66,90
	750	250	BN0657205	33,40
	750	300	BN0657305	38,10
	750	400	BN0657405	66,90
	900	250	BN0659205	33,40
	900	300	BN0659305	38,10
	900	400	BN0659405	66,90
	1000	250	BN0651205	37,50
	1000	300	BN0651305	43,50
	1000	400	BN0651405	75,20

Hanging book support - for S3, S4 & ST3

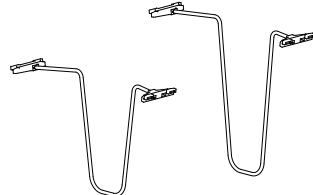
Chromed round steel with unbreakable plastic sliders. Easy adjustable.	Height mm	Shelf depth mm	Item no.	Price EUR
	220	250	B40553032	11,30
	220	300	B40553033	12,00
	280	250	B40553062	12,60
	280	300	B40553063	13,60

SHELVES

W1 & W2 - WOODEN SHELVES

See below for overview of standard wooden shelves:

W1 - WOODEN SHELF WITH H47 MM STEEL BACKEDGE - FOR BACKEDGE BOOK SUPPORT

Details:

- Module 500/750/900 mm
- Depth 250/300/400 mm
- Painted/veneer
- Steel backedge H47 mm for backedge book support
- Snapfix for intermediate shelf/
snapfix and screws for bottom shelf
- Max. weight 80 kg.
- Blockboard
- Straight

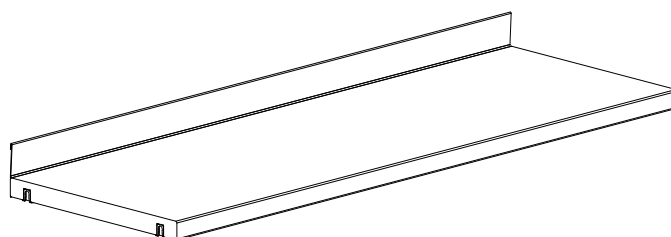

Use with:

- S1 - steel shelf
- ST1 - steel top shelf
- WT1 - wooden top shelf
- WO1 - wooden overlaying top plate

Note:

- Wooden shelves placed at the bottom, must always be fixed with snapfix and screws.
 - Shelving H1820 and 2120 with cross brace must always have one intermediate shelf fixed with snapfix and screws.
-

W2 - WOODEN SHELF

Details:

- Module 500/750/900 mm
- Depth 250/300/400 mm
- Painted/veneer
- No backedge
- Snapfix for intermediate shelf/
snapfix and screws for bottom shelf
- Max. weight 80 kg.
- Blockboard
- Straight

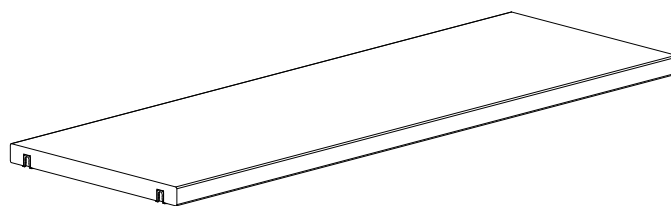

Use with:

- S2 - steel shelf
- ST2 - steel top shelf
- WT1 - wooden top shelf
- WO1 - wooden overlaying top plate

Note:

- Wooden shelves placed at the bottom, must always be fixed with snapfix and screws.
 - Shelving H1820 and 2120 with cross brace must always have one intermediate shelf fixed with snapfix and screws.
-

SHELVES

W3 & W4 - WOODEN SHELVES

See below for overview of standard wooden shelves:

W3 - WOODEN SHELF WITH H47 MM STEEL BACKEDGE

Details:

- Module 500/750/900/1000 mm
- Depth 250/300/400 mm
- Melamine/laminate
- Steel backedge H47 mm
- With/without groove for clip-on label holder
- Snapfix for intermediate shelf/
snapfix and screws for bottom shelf
- Max. weight 60 kg.
- Particleboard/blockboard
- Straight

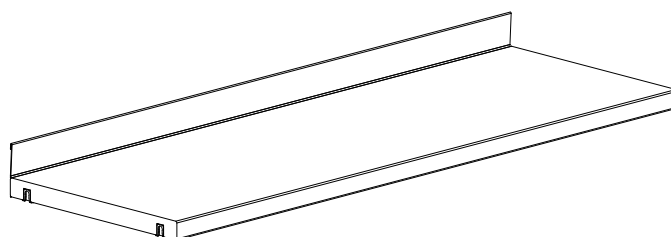

Use with:

- S3/S4 - steel shelf
- ST3 - steel top shelf
- WT1 - wooden top shelf
- WO1 - wooden overlaying top plate

Note:

- Wooden shelves placed at the bottom, must always be fixed with snapfix and screws.
 - Shelving H1820 and 2120 with cross brace must always have one intermediate shelf fixed with snapfix and screws.
-

W4 - WOODEN SHELF

Details:

- Module 500/750/900/1000 mm
- Depth 250/300/400 mm
- Melamine/laminate
- No backedge
- With/without groove for clip-on label holder
- Snapfix for intermediate shelf/
snapfix and screws for bottom shelf
- Max. weight 60 kg.
- Particleboard/blockboard
- Straight

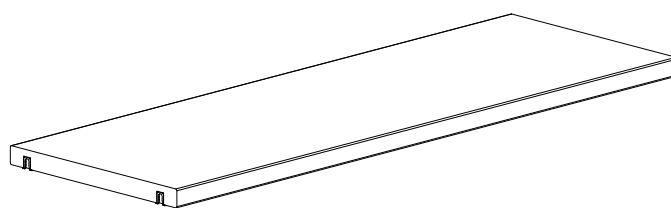

Use with:

- S3/S4 - steel shelf
- ST3 - steel top shelf
- WT1 - wooden top shelf
- WO1 - wooden overlaying top plate

Note:

- Wooden shelves placed at the bottom, must always be fixed with snapfix and screws.
 - Shelving H1820 and 2120 with cross brace must always have one intermediate shelf fixed with snapfix and screws.
-

SHELVES

W1 - WOODEN SHELF WITH H47 MM BACKEDGE AND COMPONENTS

Painted and veneered shelves are FSC-certified.

W1 - intermediate, wooden shelf with steel backedge and snapfix - for backedge book support

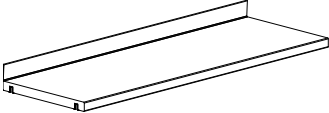
H47 mm steel backedge. Blockboard. Incl. fittings (snapfix).	Module mm	Shelf depth mm	Item no.	Melamine EUR	Painted EUR	Veneer EUR
	500	250	BN067521.ZZZZZZZZ3	-	103,40	144,60
	500	300	BN067531.ZZZZZZZZ3	-	103,40	144,60
	500	400	BN067541.ZZZZZZZZ3	-	123,10	172,30
	750	250	BN067721.ZZZZZZZZ3	-	154,80	216,90
	750	300	BN067731.ZZZZZZZZ3	-	154,80	216,90
	750	400	BN067741.ZZZZZZZZ3	-	184,70	258,10
	900	250	BN067921.ZZZZZZZZ3	-	158,30	221,20
	900	300	BN067931.ZZZZZZZZ3	-	158,30	221,20
	900	400	BN067941.ZZZZZZZZ3	-	187,60	262,60

W1 - bottom, wooden shelf with steel backedge, snapfix and screws - for backedge book support

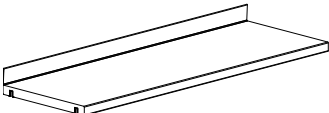
H47 mm steel backedge. Blockboard. Incl. fittings (snapfix and screws).	Module mm	Shelf depth mm	Item no.	Melamine EUR	Painted EUR	Veneer EUR
	500	250	BN067521.ZZZZZZZZ2	-	103,40	144,60
	500	300	BN067531.ZZZZZZZZ2	-	103,40	144,60
	500	400	BN067541.ZZZZZZZZ2	-	123,10	172,30
	750	250	BN067721.ZZZZZZZZ2	-	154,80	216,90
	750	300	BN067731.ZZZZZZZZ2	-	154,80	216,90
	750	400	BN067741.ZZZZZZZZ2	-	184,70	258,10
	900	250	BN067921.ZZZZZZZZ2	-	158,30	221,20
	900	300	BN067931.ZZZZZZZZ2	-	158,30	221,20
	900	400	BN067941.ZZZZZZZZ2	-	187,60	262,60

Backedge book support - for W1

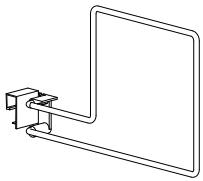
Nickel plated steel, Ø6 mm, with a nylon glider.	Shelf depth mm	Books left/right of book support	Item no.	Price EUR
	250	Left	B4011221	18,90
	300	Left	B4011222	20,40
	250/300	Left (high)	B4011223	26,50
	250	Right	B4011224	18,90
	300	Right	B4011225	20,40

SHELVES

W2 - WOODEN SHELF AND COMPONENTS

Painted and veneered shelves are FSC-certified.

W2 - intermediate, wooden shelf without backedge, with snapfix

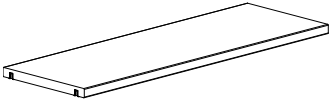
Blockboard. Incl. fittings (snapfix).	Module mm	Shelf depth mm	Item no.	Melamine EUR	Painted EUR	Veneer EUR
	500	250	BN067520.ZZZZZZZZ3	-	92,40	129,70
	500	300	BN067530.ZZZZZZZZ3	-	92,40	129,70
	500	400	BN067540.ZZZZZZZZ3	-	112,20	156,50
	750	250	BN067720.ZZZZZZZZ3	-	138,70	194,20
	750	300	BN067730.ZZZZZZZZ3	-	138,70	194,20
	750	400	BN067740.ZZZZZZZZ3	-	168,20	235,30
	900	250	BN067920.ZZZZZZZZ3	-	138,70	194,20
	900	300	BN067930.ZZZZZZZZ3	-	138,70	194,20
	900	400	BN067940.ZZZZZZZZ3	-	168,20	235,30

W2 - bottom, wooden shelf without backedge, with snapfix and screws

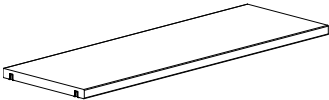
Blockboard. Incl. fittings (snapfix and screws).	Module mm	Shelf depth mm	Item no.	Melamine EUR	Painted EUR	Veneer EUR
	500	250	BN067520.ZZZZZZZZ2	-	92,40	129,70
	500	300	BN067530.ZZZZZZZZ2	-	92,40	129,70
	500	400	BN067540.ZZZZZZZZ2	-	112,20	156,50
	750	250	BN067720.ZZZZZZZZ2	-	138,70	194,20
	750	300	BN067730.ZZZZZZZZ2	-	138,70	194,20
	750	400	BN067740.ZZZZZZZZ2	-	168,20	235,30
	900	250	BN067920.ZZZZZZZZ2	-	138,70	194,20
	900	300	BN067930.ZZZZZZZZ2	-	138,70	194,20
	900	400	BN067940.ZZZZZZZZ2	-	168,20	235,30

Hanging book support - for S2 and W2/4 with rail

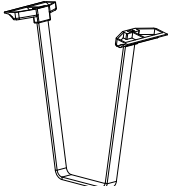
Available in chrome steel or standard steel colours.	Type	Height mm	Item no.	Price EUR
	Normal	200	B4011242	10,10
	Folio	250	B4011245	10,90

Rail for fixing hanging book support under W2 & W4

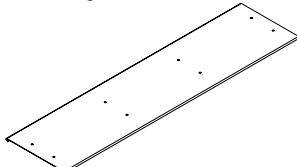
Fix underneath wooden shelf. For book support B40112x. Incl. fittings	Module	Item no.	Price EUR
	750	B4022007	36,30
	900	B4022009	36,30

SHELVES

W3 - WOODEN SHELF WITH H47 MM BACKEDGE

W3 - intermediate, wooden shelf with steel backedge, with snapfix, without groove for clip-on label holder

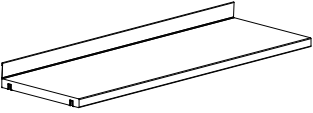
H47 mm steel backedge. Particleboard. Incl. fittings (snapfix)	Module mm	Shelf depth mm	Item no.	Melamine EUR	Painted EUR	Veneer EUR
	500	250	BN07052106ZZZZZ3	78,20	-	-
	500	300	BN07053106ZZZZZ3	78,20	-	-
	500	400	BN07054106ZZZZZ3	95,00	-	-
	750	250	BN07072106ZZZZZ3	118,00	-	-
	750	300	BN07073106ZZZZZ3	118,00	-	-
	750	400	BN07074106ZZZZZ3	142,80	-	-
	900	250	BN07092106ZZZZZ3	118,00	-	-
	900	300	BN07093106ZZZZZ3	118,00	-	-
	900	400	BN07094106ZZZZZ3	142,80	-	-

W3 - intermediate, wooden shelf with steel backedge, with snapfix, without groove for clip-on label holder

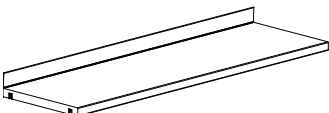
H47 mm steel backedge. Blockboard. Incl. fittings (snapfix)	Module mm	Shelf depth mm	Item no.	Laminate EUR	Painted EUR	Veneer EUR
	1000	250	BN07012103ZZZZZ3	215,00	-	-
	1000	300	BN07013103ZZZZZ3	215,00	-	-
	1000	400	BN07014103ZZZZZ3	260,10	-	-

W3 - intermediate, wooden shelf with steel backedge, with snapfix, with groove for clip-on label holder

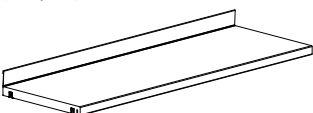
H47 mm steel backedge. Particleboard. Incl. fittings (snapfix)	Module mm	Shelf depth mm	Item no.	Melamine EUR	Painted EUR	Veneer EUR
	500	250	BN07052116ZZZZZ3	80,90	-	-
	500	300	BN07053116ZZZZZ3	80,90	-	-
	500	400	BN07054116ZZZZZ3	97,30	-	-
	750	250	BN07072116ZZZZZ3	120,20	-	-
	750	300	BN07073116ZZZZZ3	120,20	-	-
	750	400	BN07074116ZZZZZ3	145,00	-	-
	900	250	BN07092116ZZZZZ3	120,20	-	-
	900	300	BN07093116ZZZZZ3	120,20	-	-
	900	400	BN07094116ZZZZZ3	145,00	-	-

W3 - intermediate, wooden shelf with steel backedge, with snapfix, with groove for clip-on label holder

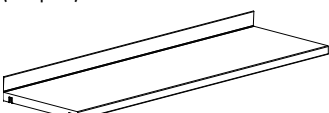
H47 mm steel backedge. Blockboard. Incl. fittings (snapfix)	Module mm	Shelf depth mm	Item no.	Laminate EUR	Painted EUR	Veneer EUR
	1000	250	BN07012113ZZZZZ3	219,10	-	-
	1000	300	BN07013113ZZZZZ3	219,10	-	-
	1000	400	BN07014113ZZZZZ3	264,20	-	-

SHELVES

W3 - WOODEN SHELF WITH H47 MM BACKEDGE

W3 - bottom, wooden shelf with steel backedge, with snapfix and screws, without groove for clip-on label holder

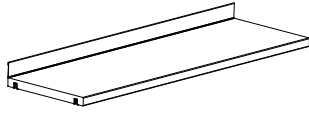
H47 mm steel backedge. Particleboard. Incl. fittings (snapfix and screws).	Module mm	Shelf depth mm	Item no.	Melamine EUR	Painted EUR	Veneer EUR
	500	250	BN07052106ZZZZZZ2	78,20	-	-
	500	300	BN07053106ZZZZZZ2	78,20	-	-
	500	400	BN07054106ZZZZZZ2	95,00	-	-
	750	250	BN07072106ZZZZZZ2	118,00	-	-
	750	300	BN07073106ZZZZZZ2	118,00	-	-
	750	400	BN07074106ZZZZZZ2	142,80	-	-
	900	250	BN07092106ZZZZZZ2	118,00	-	-
	900	300	BN07093106ZZZZZZ2	118,00	-	-
	900	400	BN07094106ZZZZZZ2	142,80	-	-

W3 - bottom, wooden shelf with steel backedge, with snapfix and screws, without groove for clip-on label holder

H47 mm steel backedge. Blockboard. Incl. fittings (snapfix and screws).	Module mm	Shelf depth mm	Item no.	Laminate EUR	Painted EUR	Veneer EUR
	1000	250	BN07012103ZZZZZZ2	215,00	-	-
	1000	300	BN07013103ZZZZZZ2	215,00	-	-
	1000	400	BN07014103ZZZZZZ2	260,10	-	-

W3 - bottom, wooden shelf with steel backedge, with snapfix and screws, with groove for clip-on label holder

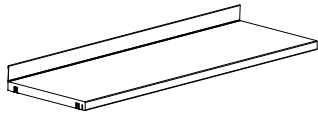
H47 mm steel backedge. Particleboard. Incl. fittings (snapfix and screws).	Module mm	Shelf depth mm	Item no.	Melamine EUR	Painted EUR	Veneer EUR
	500	250	BN07052116ZZZZZZ2	80,90	-	-
	500	300	BN07053116ZZZZZZ2	80,90	-	-
	500	400	BN07054116ZZZZZZ2	97,30	-	-
	750	250	BN07072116ZZZZZZ2	120,20	-	-
	750	300	BN07073116ZZZZZZ2	120,20	-	-
	750	400	BN07074116ZZZZZZ2	145,00	-	-
	900	250	BN07092116ZZZZZZ2	120,20	-	-
	900	300	BN07093116ZZZZZZ2	120,20	-	-
	900	400	BN07094116ZZZZZZ2	145,00	-	-

W3 - bottom, wooden shelf with steel backedge, with snapfix and screws, with groove for clip-on label holder

H47 mm steel backedge. Blockboard. Incl. fittings (snapfix and screws).	Module mm	Shelf depth mm	Item no.	Laminate EUR	Painted EUR	Veneer EUR
	1000	250	BN07012113ZZZZZZ2	219,10	-	-
	1000	300	BN07013113ZZZZZZ2	219,10	-	-
	1000	400	BN07014113ZZZZZZ2	264,20	-	-

SHELVES

W4 - WOODEN SHELF

W4 - intermediate, wooden shelf without backedge, with snapfix, without groove for clip-on label holder

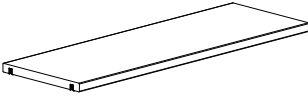
Particleboard. Incl. fittings (snapfix)	Module mm	Shelf depth mm	Item no.	Melamine EUR	Painted EUR	Veneer EUR
	500	250	BN07052006ZZZZZ3	68,40	-	-
	500	300	BN07053006ZZZZZ3	68,40	-	-
	500	400	BN07054006ZZZZZ3	85,40	-	-
	750	250	BN07072006ZZZZZ3	103,20	-	-
	750	300	BN07073006ZZZZZ3	103,20	-	-
	750	400	BN07074006ZZZZZ3	128,20	-	-
	900	250	BN07092006ZZZZZ3	100,60	-	-
	900	300	BN07093006ZZZZZ3	100,60	-	-
	900	400	BN07094006ZZZZZ3	124,90	-	-

W4 - intermediate, wooden shelf without backedge, with snapfix, without groove for clip-on label holder

Blockboard. Incl. fittings (snapfix)	Module mm	Shelf depth mm	Item no.	Laminate EUR	Painted EUR	Veneer EUR
	1000	250	BN07012003ZZZZZ3	183,30	-	-
	1000	300	BN07013003ZZZZZ3	183,30	-	-
	1000	400	BN07014003ZZZZZ3	227,70	-	-

W4 - intermediate, wooden shelf without backedge, with snapfix, with groove for clip-on label holder

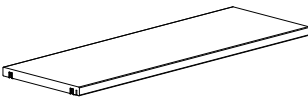
Particleboard. Incl. fittings (snapfix)	Module mm	Shelf depth mm	Item no.	Melamine EUR	Painted EUR	Veneer EUR
	500	250	BN07052016ZZZZZ3	71,10	-	-
	500	300	BN07053016ZZZZZ3	71,10	-	-
	500	400	BN07054016ZZZZZ3	87,50	-	-
	750	250	BN07072016ZZZZZ3	105,50	-	-
	750	300	BN07073016ZZZZZ3	105,50	-	-
	750	400	BN07074016ZZZZZ3	130,30	-	-
	900	250	BN07092016ZZZZZ3	102,40	-	-
	900	300	BN07093016ZZZZZ3	102,40	-	-
	900	400	BN07094016ZZZZZ3	127,60	-	-

W4 - intermediate, wooden shelf without backedge, with snapfix, with groove for clip-on label holder

Blockboard. Incl. fittings (snapfix)	Module mm	Shelf depth mm	Item no.	Laminate EUR	Painted EUR	Veneer EUR
	1000	250	BN07012013ZZZZZ3	186,60	-	-
	1000	300	BN07013013ZZZZZ3	186,60	-	-
	1000	400	BN07014013ZZZZZ3	232,50	-	-

SHELVES

W4 - WOODEN SHELF

W4 - bottom, wooden shelf without backedge, with snapfix and screws, without groove for clip-on label holder

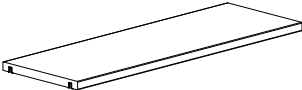
Particleboard. Incl. fittings (snapfix and screws).	Module mm	Shelf depth mm	Item no.	Melamine EUR	Painted EUR	Veneer EUR
	500	250	BN07052006ZZZZZZ2	68,40	-	-
	500	300	BN07053006ZZZZZZ2	68,40	-	-
	500	400	BN07054006ZZZZZZ2	85,40	-	-
	750	250	BN07072006ZZZZZZ2	103,20	-	-
	750	300	BN07073006ZZZZZZ2	103,20	-	-
	750	400	BN07074006ZZZZZZ2	128,20	-	-
	900	250	BN07092006ZZZZZZ2	100,60	-	-
	900	300	BN07093006ZZZZZZ2	100,60	-	-
	900	400	BN07094006ZZZZZZ2	124,90	-	-

W4 - bottom, wooden shelf without backedge, with snapfix and screws, without groove for clip-on label holder

Blockboard. Incl. fittings (snapfix and screws).	Module mm	Shelf depth mm	Item no.	Laminate EUR	Painted EUR	Veneer EUR
	1000	250	BN07012003ZZZZZZ2	183,30	-	-
	1000	300	BN07013003ZZZZZZ2	183,30	-	-
	1000	400	BN07014003ZZZZZZ2	227,70	-	-

W4 - bottom, wooden shelf without backedge, with snapfix and screws, with groove for clip-on label holder

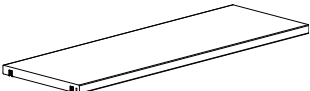
Particleboard. Incl. fittings (snapfix and screws).	Module mm	Shelf depth mm	Item no.	Melamine EUR	Painted EUR	Veneer EUR
	500	250	BN07052016ZZZZZZ2	71,10	-	-
	500	300	BN07053016ZZZZZZ2	71,10	-	-
	500	400	BN07054016ZZZZZZ2	87,50	-	-
	750	250	BN07072016ZZZZZZ2	105,50	-	-
	750	300	BN07073016ZZZZZZ2	105,50	-	-
	750	400	BN07074016ZZZZZZ2	130,30	-	-
	900	250	BN07092016ZZZZZZ2	102,40	-	-
	900	300	BN07093016ZZZZZZ2	102,40	-	-
	900	400	BN07094016ZZZZZZ2	127,60	-	-

W4 - bottom, wooden shelf without backedge, with snapfix and screws, with groove for clip-on label holder

Blockboard. Incl. fittings (snapfix and screws).	Module mm	Shelf depth mm	Item no.	Laminate EUR	Painted EUR	Veneer EUR
	1000	250	BN07012013ZZZZZZ2	186,60	-	-
	1000	300	BN07013013ZZZZZZ2	186,60	-	-
	1000	400	BN07014013ZZZZZZ2	232,50	-	-

SHELVES

WT1 - WOODEN TOP SHELVES

Choose between a steel or wooden top shelf (placed in between the wooden panels) or a wooden overlaying top plate (placed on top of the panels).

WT1 - WOODEN TOP SHELF

Details:

- Module 500/750/900/1000 mm
- Depth 250/300/400 mm
- Painted/veneer
- Single-sided standard depth
- Single-sided full depth
- Double-sided
- Snapfix and screws
- Max. weight 100 kg. (Norm EN14073-3)
- Particleboard

Use with:

- S1/S2/S3/S4 - steel shelves
- W1/W2/W3/W4 - wooden shelves
- WP1/2/5/6 - wooden panel
- WBP1/WBP3 - wooden back panel for standard depth
- WBP2/WBP4 - wooden back panel for full depth
- WBP2/WBP4 - wooden back panel for double-sided

Note:

- Wooden top shelves must always be fixed with snapfix and screws.

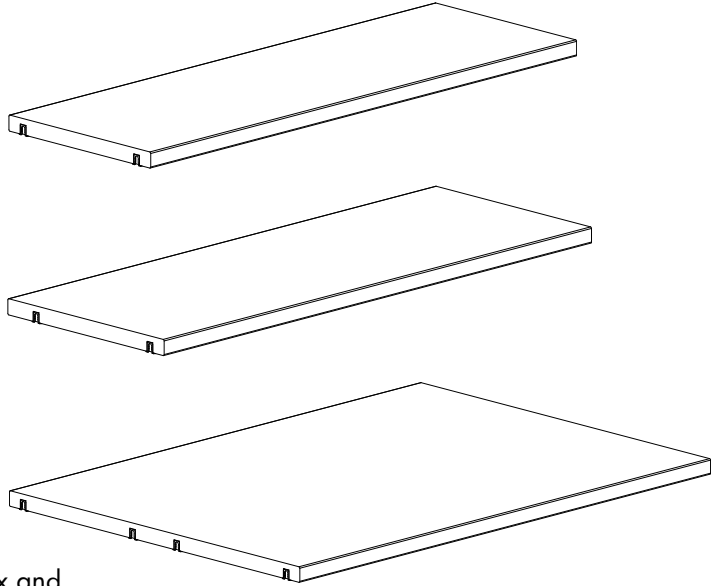

SHELVES

WT3 - WOODEN TOP SHELVES

Choose between a steel or wooden top shelf (placed in between the wooden panels) or a wooden overlaying top plate (placed on top of the panels).

WT3 - WOODEN TOP SHELF

Details:

- Module 500/750/900/1000 mm
- Depth 250/300/400 mm
- Melamine
- Single-sided standard depth
- Single-sided full depth
- Double-sided
- Snapfix and screws
- Max. weight 100 kg. (Norm EN14073-3)
- Particleboard

Use with:

- S1/S2/S3/S4 - steel shelves
- W1/W2/W3/W4 - wooden shelves
- WP1/2/5/6 - wooden panel
- WBP1/WBP3 - wooden back panel for standard depth
- WBP2/WBP4 - wooden back panel for full depth
- WBP2/WBP4 - wooden back panel for double-sided

Note:

- Wooden top shelves must always be fixed with snapfix and screws.

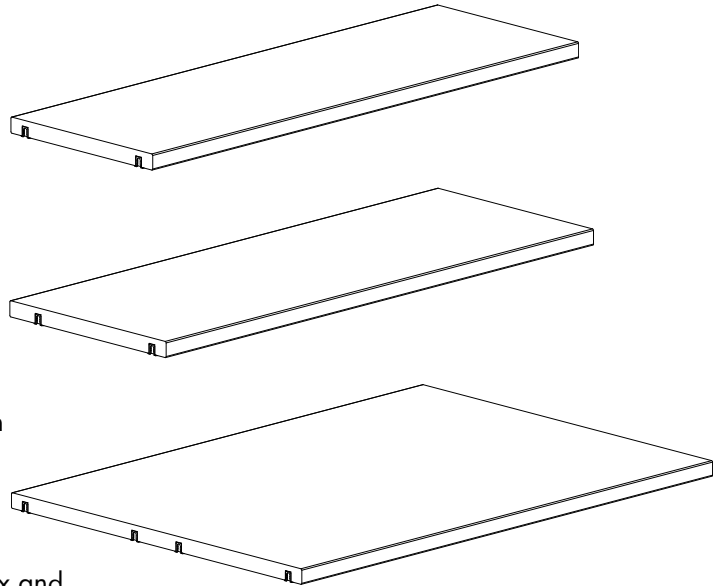

SHELVES

WT1 - WOODEN TOP SHELF - PAINTED/VENEER

Painted and veneered shelves are FSC-certified.

WT1 - single-sided wooden top shelf - standard depth

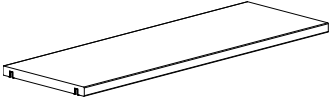
Particleboard. Incl. fittings (snapfix and screws).	Module mm	Shelf depth mm	Item no.	Melamine EUR	Painted EUR	Veneer EUR
	500	250	BN0765218.	-	104,50	146,70
	500	300	BN0765318.	-	116,30	163,20
	500	400	BN0765418.	-	132,10	184,50
	750	250	BN0767218.	-	157,30	220,00
	750	300	BN0767318.	-	174,90	244,80
	750	400	BN0767418.	-	198,10	277,10
	900	250	BN0769218.	-	157,30	220,00
	900	300	BN0769318.	-	174,90	244,80
	900	400	BN0769418.	-	198,10	277,10
	1000	250	BN0761218.	-	176,40	246,60
	1000	300	BN0761318.	-	194,80	272,60
	1000	400	BN0761418.	-	221,40	310,70

WT1 - single-sided wooden top shelf - full depth

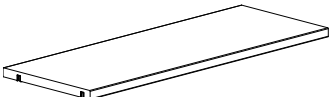
Particleboard. Incl. fittings (snapfix and screws).	Module mm	Shelf depth mm	Item no.	Melamine EUR	Painted EUR	Veneer EUR
	500	250 = 280	BN0765219.	-	104,50	146,70
	500	300 = 330	BN0765319.	-	116,30	163,20
	500	400 = 430	BN0765419.	-	132,10	184,50
	750	250 = 280	BN0767219.	-	157,30	220,00
	750	300 = 330	BN0767319.	-	174,90	244,80
	750	400 = 430	BN0767419.	-	198,10	277,10
	900	250 = 280	BN0769219.	-	157,30	220,00
	900	300 = 330	BN0769319.	-	174,90	244,80
	900	400 = 430	BN0769419.	-	198,10	277,10
	1000	250 = 280	BN0761219.	-	176,40	246,60
	1000	300 = 330	BN0761319.	-	194,80	272,60
	1000	400 = 430	BN0761419.	-	221,40	310,70

WT1 - double-sided wooden top shelf

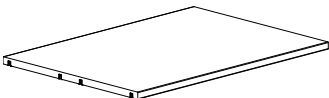
Particleboard. Incl. fittings (snapfix and screws).	Module mm	Shelf depth mm	Item no.	Melamine EUR	Painted EUR	Veneer EUR
	500	2 x 250 = 537	BN0765228.	-	139,90	195,80
	500	2 x 300 = 637	BN0765328.	-	214,40	300,10
	500	2 x 400 = 837	BN0765428.	-	327,30	457,80
	750	2 x 250 = 537	BN0767228.	-	209,70	293,30
	750	2 x 300 = 637	BN0767328.	-	321,80	450,40
	750	2 x 400 = 837	BN0767428.	-	490,70	686,80
	900	2 x 250 = 537	BN0769228.	-	209,70	293,30
	900	2 x 300 = 637	BN0769328.	-	321,80	450,40
	900	2 x 400 = 837	BN0769428.	-	490,70	686,80
	1000	2 x 250 = 537	BN0761228.	-	233,30	326,30
	1000	2 x 300 = 637	BN0761328.	-	357,80	500,40
	1000	2 x 400 = 837	BN0761428.	-	545,40	763,40

SHELVES

WT3 - WOODEN TOP SHELF - MELAMINE

WT3 - Single-sided wooden top shelf - standard depth

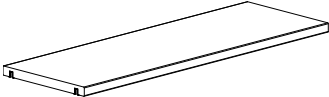
Particleboard. Incl. fittings (snapfix and screws).	Module mm	Shelf depth mm	Item no.	Melamine EUR	Painted EUR	Veneer EUR
	500	250	BN07752186	88,70	-	-
	500	300	BN07753186	99,30	-	-
	500	400	BN07754186	112,20	-	-
	750	250	BN07772186	133,50	-	-
	750	300	BN07773186	148,50	-	-
	750	400	BN07774186	168,20	-	-
	900	250	BN07792186	133,50	-	-
	900	300	BN07793186	148,50	-	-
	900	400	BN07794186	168,20	-	-
	1000	250	BN07712186	149,90	-	-
	1000	300	BN07713186	165,70	-	-
	1000	400	BN07714186	188,40	-	-

WT3 - Single-sided wooden top shelf - full depth

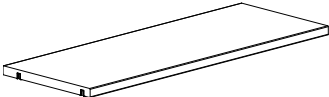
Particleboard. Incl. fittings (snapfix and screws).	Module mm	Shelf depth mm	Item no.	Melamine EUR	Painted EUR	Veneer EUR
	500	250 = 280	BN07752196	88,70	-	-
	500	300 = 330	BN07753196	99,30	-	-
	500	400 = 430	BN07754196	112,20	-	-
	750	250 = 280	BN07772196	133,50	-	-
	750	300 = 330	BN07773196	148,50	-	-
	750	400 = 430	BN07774196	168,20	-	-
	900	250 = 280	BN07792196	133,50	-	-
	900	300 = 330	BN07793196	148,50	-	-
	900	400 = 430	BN07794196	168,20	-	-
	1000	250 = 280	BN07712196	149,90	-	-
	1000	300 = 330	BN07713196	165,70	-	-
	1000	400 = 430	BN07714196	188,40	-	-

WT3 - Double-sided wooden top shelf

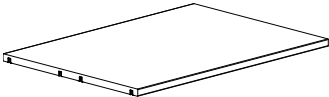
Particleboard. Incl. fittings (snapfix and screws).	Module mm	Shelf depth mm	Item no.	Melamine EUR	Painted EUR	Veneer EUR
	500	2 x 250 = 537	BN07752286	118,60	-	-
	500	2 x 300 = 637	BN07753286	182,30	-	-
	500	2 x 400 = 837	BN07754286	277,90	-	-
	750	2 x 250 = 537	BN07772286	178,20	-	-
	750	2 x 300 = 637	BN07773286	273,80	-	-
	750	2 x 400 = 837	BN07774286	417,20	-	-
	900	2 x 250 = 537	BN07792286	178,20	-	-
	900	2 x 300 = 637	BN07793286	273,80	-	-
	900	2 x 400 = 837	BN07794286	417,20	-	-
	1000	2 x 250 = 537	BN07712286	198,10	-	-
	1000	2 x 300 = 637	BN07713286	304,00	-	-
	1000	2 x 400 = 837	BN07714286	463,50	-	-

SHELVES

WO1 - WOODEN OVERLAYING TOP PLATE

Choose between a steel or wooden top shelf (placed in between the wooden panels) or a wooden overlying top plate (placed on top of the panels).

WO1 - WOODEN OVERLAYING TOP PLATE

Details:

- Module 500/750/900/100 mm
- Depth 250/300/400 mm
- Melamine/painted/veneer
- Single-/double-sided
- Freestanding/outer/intermediate
- Max. weight 25 kg.
- Particle board

Use with:

- S1/S2/S3/S4 - steel shelves
- W1/W2/W3/W4 - wooden shelves
- WP3/4/7/8 - wooden panel
- WBP1/3 - wooden back panel

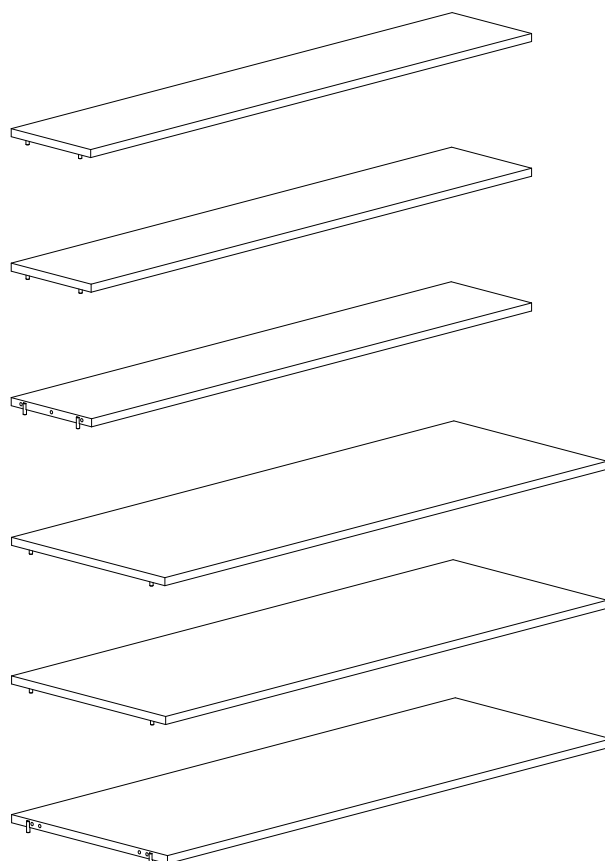

SHELVES

WO1 - WOODEN OVERLAYING TOP PLATE - SINGLE-SIDED

Painted and veneered shelves are FSC-certified.

WO1 - Single-sided wooden overlaying top plate - freestanding

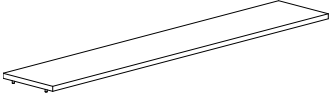
Particleboard. Incl. fittings.	Module mm	Shelf depth mm	No. of bays	Item no.	Melamine EUR	Painted EUR	Veneer EUR
	500	250	1	BN0303515.	106,70	125,30	175,70
	500	250	2	BN0303525.	191,90	225,90	316,40
	500	250	3	BN0303535.	288,00	338,80	474,40
	500	300	1	BN0305515.	118,20	139,30	195,00
	500	300	2	BN0305525.	213,20	251,10	350,90
	500	300	3	BN0305535.	319,90	376,50	526,60
	500	400	1	BN0307515.	130,70	153,20	214,90
	500	400	2	BN0307525.	234,50	275,70	385,90
	500	400	3	BN0307535.	351,70	413,70	579,20
	750	250	1	BN0303715.	160,00	188,20	263,40
	750	250	2	BN0303725.	287,80	338,60	473,70
	750	250	3	BN0303735.	431,60	507,70	710,90
	750	300	1	BN0305715.	177,80	209,30	292,90
	750	300	2	BN0305725.	319,50	376,00	526,60
	750	300	3	BN0305735.	479,70	564,30	790,20
	750	400	1	BN0307715.	195,60	230,00	322,00
	750	400	2	BN0307725.	351,70	413,70	579,00
	750	400	3	BN0307735.	527,40	620,80	869,30
900	250	1	BN0303915.	160,00	188,20	263,40	
900	250	2	BN0303925.	287,80	338,60	473,70	
900	300	1	BN0305915.	177,80	209,30	292,90	
900	300	2	BN0305925.	319,50	376,00	526,60	
900	400	1	BN0307915.	195,60	230,00	322,00	
900	400	2	BN0307925.	351,70	413,70	579,00	
1000	250	1	BN0303115.	177,80	209,30	292,90	
1000	250	2	BN0303125.	319,50	376,00	526,60	
1000	300	1	BN0305115.	197,70	232,50	325,30	
1000	300	2	BN0305125.	355,40	418,00	585,40	
1000	400	1	BN0307115.	217,10	255,40	358,00	
1000	400	2	BN0307125.	391,00	460,00	643,30	

SHELVES

WO1 - WOODEN OVERLAYING TOP PLATE - SINGLE-SIDED

Painted and veneered shelves are FSC-certified.

WO1 - Single-sided wooden overlaying top plate - outer

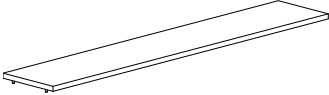
Particleboard. Incl. fittings.	Module mm	Shelf depth mm	No. of bays	Item no.	Melamine EUR	Painted EUR	Veneer EUR
	500	250	1	BN0303514.	106,70	125,30	175,70
	500	250	2	BN0303524.	191,90	225,90	316,40
	500	250	3	BN0303534.	288,00	338,80	474,40
	500	300	1	BN0305514.	118,20	139,30	195,00
	500	300	2	BN0305524.	213,20	251,10	350,90
	500	300	3	BN0305534.	319,90	376,50	526,60
	500	400	1	BN0307514.	130,70	153,20	214,90
	500	400	2	BN0307524.	234,50	275,70	385,90
	500	400	3	BN0307534.	351,70	413,70	579,20
	750	250	1	BN0303714.	160,00	188,20	263,40
	750	250	2	BN0303724.	287,80	338,60	473,70
	750	250	3	BN0303734.	431,60	507,70	710,90
	750	300	1	BN0305714.	177,80	209,30	292,90
	750	300	2	BN0305724.	319,50	376,00	526,60
	750	300	3	BN0305734.	479,70	564,30	790,20
	750	400	1	BN0307714.	195,60	230,00	322,00
	750	400	2	BN0307724.	351,70	413,70	579,00
	750	400	3	BN0307734.	527,40	620,80	869,30
900	250	1	BN0303914.	160,00	188,20	263,40	
900	250	2	BN0303924.	287,80	338,60	473,70	
900	300	1	BN0305914.	177,80	209,30	292,90	
900	300	2	BN0305924.	319,50	376,00	526,60	
900	400	1	BN0307914.	195,60	230,00	322,00	
900	400	2	BN0307924.	351,70	413,70	579,00	
1000	250	1	BN0303114.	177,80	209,30	292,90	
1000	250	2	BN0303124.	319,50	376,00	526,60	
1000	300	1	BN0305114.	197,70	232,50	325,30	
1000	300	2	BN0305124.	355,40	418,00	585,40	
1000	400	1	BN0307114.	217,10	255,40	358,00	
1000	400	2	BN0307124.	391,00	460,00	643,30	

SHELVES

WO1 - WOODEN OVERLAYING TOP PLATE - SINGLE-SIDED

Painted and veneered shelves are FSC-certified.

WO1 - Single-sided wooden overlaying top plate - intermediate

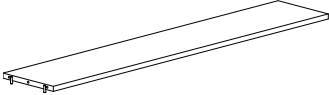
Particleboard. Incl. fittings.	Module mm	Shelf depth mm	No. of bays	Item no.	Melamine EUR	Painted EUR	Veneer EUR
	500	250	1	BN0303513.	106,70	125,30	175,70
	500	250	2	BN0303523.	191,90	225,90	316,40
	500	250	3	BN0303533.	288,00	338,80	474,40
	500	300	1	BN0305513.	118,20	139,30	195,00
	500	300	2	BN0305523.	213,20	251,10	350,90
	500	300	3	BN0305533.	319,90	376,50	526,60
	500	400	1	BN0307513.	130,70	153,20	214,90
	500	400	2	BN0307523.	234,50	275,70	385,90
	500	400	3	BN0307533.	351,70	413,70	579,20
	750	250	1	BN0303713.	160,00	188,20	263,40
	750	250	2	BN0303723.	287,80	338,60	473,70
	750	250	3	BN0303733.	431,60	507,70	710,90
	750	300	1	BN0305713.	177,80	209,30	292,90
	750	300	2	BN0305723.	319,50	376,00	526,60
	750	300	3	BN0305733.	479,70	564,30	790,20
	750	400	1	BN0307713.	195,60	230,00	322,00
	750	400	2	BN0307723.	351,70	413,70	579,00
	750	400	3	BN0307733.	527,40	620,80	869,30
900	250	1	BN0303913.	160,00	188,20	263,40	
900	250	2	BN0303923.	287,80	338,60	473,70	
900	300	1	BN0305913.	177,80	209,30	292,90	
900	300	2	BN0305923.	319,50	376,00	526,60	
900	400	1	BN0307913.	195,60	230,00	322,00	
900	400	2	BN0307923.	351,70	413,70	579,00	
1000	250	1	BN0303113.	177,80	209,30	292,90	
1000	250	2	BN0303123.	319,50	376,00	526,60	
1000	300	1	BN0305113.	197,70	232,50	325,30	
1000	300	2	BN0305123.	355,40	418,00	585,40	
1000	400	1	BN0307113.	217,10	255,40	358,00	
1000	400	2	BN0307123.	391,00	460,00	643,30	

SHELVES

WO1 - WOODEN OVERLAYING TOP PLATE - DOUBLE-SIDED

Painted and veneered shelves are FSC-certified.

WO1 - Double-sided wooden overlaying top plate - freestanding

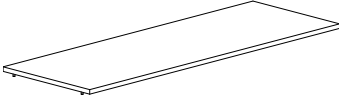
Particleboard. Incl. fittings.	Module mm	Shelf depth mm	No. of bays	Item no.	Melamine EUR	Painted EUR	Veneer EUR
	500	250	1	BN0304515.	164,30	193,10	270,00
	500	250	2	BN0304525.	295,10	347,20	485,80
	500	250	3	BN0304535.	443,00	521,10	729,80
	500	300	1	BN0306515.	182,10	214,40	300,10
	500	300	2	BN0306525.	327,70	385,70	539,90
	500	300	3	BN0306535.	492,00	578,80	810,50
	500	400	1	BN0308515.	200,50	235,70	330,20
	500	400	2	BN0308525.	360,50	424,40	593,80
	500	400	3	BN0308535.	541,10	636,80	891,40
	750	250	1	BN0304715.	246,20	290,00	405,30
	750	250	2	BN0304725.	443,00	521,10	729,40
	750	250	3	BN0304735.	664,20	781,40	1.094,10
	750	300	1	BN0306715.	273,80	321,80	450,40
	750	300	2	BN0306725.	491,80	578,60	810,10
	750	300	3	BN0306735.	738,40	868,40	1.216,00
	750	400	1	BN0308715.	300,90	353,90	495,50
	750	400	2	BN0308725.	540,90	636,60	891,20
	750	400	3	BN0308735.	812,10	955,50	1.337,10
900	250	1	BN0304915.	246,20	290,00	405,30	
900	250	2	BN0304925.	443,00	521,10	729,40	
900	300	1	BN0306915.	273,80	321,80	450,40	
900	300	2	BN0306925.	491,80	578,60	810,10	
900	400	1	BN0308915.	300,90	353,90	495,50	
900	400	2	BN0308925.	540,90	636,60	891,20	
1000	250	1	BN0304115.	273,80	321,80	450,40	
1000	250	2	BN0304125.	491,80	578,60	810,10	
1000	300	1	BN0306115.	304,00	357,60	500,20	
1000	300	2	BN0306125.	546,50	642,90	900,00	
1000	400	1	BN0308115.	334,10	393,00	550,10	
1000	400	2	BN0308125.	600,90	707,00	990,30	

SHELVES

WO1 - WOODEN OVERLAYING TOP PLATE - DOUBLE-SIDED

Painted and veneered shelves are FSC-certified.

WO1 - Double-sided wooden overlaying top plate - outer

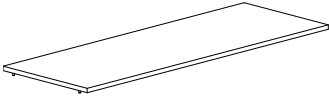
Particleboard. Incl. fittings.	Module mm	Shelf depth mm	No. of bays	Item no.	Melamine EUR	Painted EUR	Veneer EUR
	500	250	1	BN0304514.	164,30	193,10	270,00
	500	250	2	BN0304524.	295,10	347,20	485,80
	500	250	3	BN0304534.	443,00	521,10	729,80
	500	300	1	BN0306514.	182,10	214,40	300,10
	500	300	2	BN0306524.	327,70	385,70	539,90
	500	300	3	BN0306534.	492,00	578,80	810,50
	500	400	1	BN0308514.	200,50	235,70	330,20
	500	400	2	BN0308524.	360,50	424,40	593,80
	500	400	3	BN0308534.	541,10	636,80	891,40
	750	250	1	BN0304714.	246,20	290,00	405,30
	750	250	2	BN0304724.	443,00	521,10	729,40
	750	250	3	BN0304734.	664,20	781,40	1.094,10
	750	300	1	BN0306714.	273,80	321,80	450,40
	750	300	2	BN0306724.	491,80	578,60	810,10
	750	300	3	BN0306734.	738,40	868,40	1.216,00
	750	400	1	BN0308714.	300,90	353,90	495,50
	750	400	2	BN0308724.	540,90	636,60	891,20
	750	400	3	BN0308734.	812,10	955,50	1.337,10
900	250	1	BN0304914.	246,20	290,00	405,30	
900	250	2	BN0304924.	443,00	521,10	729,40	
900	300	1	BN0306914.	273,80	321,80	450,40	
900	300	2	BN0306924.	491,80	578,60	810,10	
900	400	1	BN0308914.	300,90	353,90	495,50	
900	400	2	BN0308924.	540,90	636,60	891,20	
1000	250	1	BN0304114.	273,80	321,80	450,40	
1000	250	2	BN0304124.	491,80	578,60	810,10	
1000	300	1	BN0306114.	304,00	357,60	500,20	
1000	300	2	BN0306124.	546,50	642,90	900,00	
1000	400	1	BN0308114.	334,10	393,00	550,10	
1000	400	2	BN0308124.	600,90	707,00	990,30	

SHELVES

WO1 - WOODEN OVERLAYING TOP PLATE - DOUBLE-SIDED

Painted and veneered shelves are FSC-certified.

WO1 - Double-sided wooden overlaying top plate - intermediate

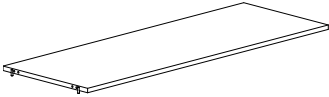
Particleboard. Incl. fittings.	Module mm	Shelf depth mm	No. of bays	Item no.	Melamine EUR	Painted EUR	Veneer EUR
	500	250	1	BN0304513.	164,30	193,10	270,00
	500	250	2	BN0304523.	295,10	347,20	485,80
	500	250	3	BN0304533.	443,00	521,10	729,80
	500	300	1	BN0306513.	182,10	214,40	300,10
	500	300	2	BN0306523.	327,70	385,70	539,90
	500	300	3	BN0306533.	492,00	578,80	810,50
	500	400	1	BN0308513.	200,50	235,70	330,20
	500	400	2	BN0308523.	360,50	424,40	593,80
	500	400	3	BN0308533.	541,10	636,80	891,40
	750	250	1	BN0304713.	246,20	290,00	405,30
	750	250	2	BN0304723.	443,00	521,10	729,40
	750	250	3	BN0304733.	664,20	781,40	1.094,10
	750	300	1	BN0306713.	273,80	321,80	450,40
	750	300	2	BN0306723.	491,80	578,60	810,10
	750	300	3	BN0306733.	738,40	868,40	1.216,00
	750	400	1	BN0308713.	300,90	353,90	495,50
	750	400	2	BN0308723.	540,90	636,60	891,20
	750	400	3	BN0308733.	812,10	955,50	1.337,10
900	250	1	BN0304913.	246,20	290,00	405,30	
900	250	2	BN0304923.	443,00	521,10	729,40	
900	300	1	BN0306913.	273,80	321,80	450,40	
900	300	2	BN0306923.	491,80	578,60	810,10	
900	400	1	BN0308913.	300,90	353,90	495,50	
900	400	2	BN0308923.	540,90	636,60	891,20	
1000	250	1	BN0304113.	273,80	321,80	450,40	
1000	250	2	BN0304123.	491,80	578,60	810,10	
1000	300	1	BN0306113.	304,00	357,60	500,20	
1000	300	2	BN0306123.	546,50	642,90	900,00	
1000	400	1	BN0308113.	334,10	393,00	550,10	
1000	400	2	BN0308123.	600,90	707,00	990,30	

SHELVES

DISPLAY & STORAGE

Steel shelf for pocketbooks, CD's and DVD's

Incl. fittings.
H200 x D225 mm

Module
mm

Item no.

Price
EUR

900

BN520

125,80

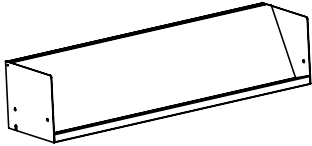

Steel shelf for CD's

Incl. fittings.
H175 x D200 mm

Module
mm

Item no.

Price
EUR

750
900

B7851737
B7851739

221,70
221,70

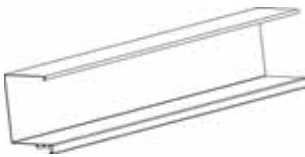

Steel shelf for DVD's

Incl. fittings.
H273 x D300 mm.

Module
mm

Item no.

Price
EUR

750
900

B7851707
B7851709

221,70
221,70



SHELVES

DISPLAY & STORAGE

Steel shelf - 4 compartments (W22.4 cm) with 3 steel dividers

Incl. fittings. W900 x H200 x Dxx mm.
Capacity: 75 picture books

Depth
mm

Item no.

Price
EUR

250
300

BN5162
BN5163

158,60
175,60

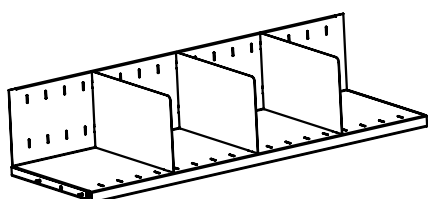

Sloping bottom shelf

Incl. fittings

Module
mm

Depth of
shelving - mm

Item no.

Price
EUR

500 250
500 300

BN53052
BN53053

62,70
62,70

750 250
750 300

BN53072
BN53073

62,70
62,70

900 250
900 300

BN53092
BN53093

62,70
62,70

1000 250
1000 300

BN53012
BN53013

62,70
62,70

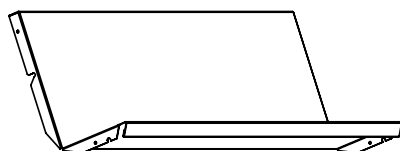

FUNCTIONS

STEEL BROWSERS

Single browser - without/with pull-out

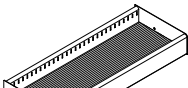
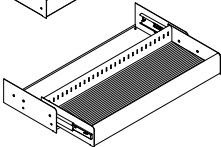
Module 750 mm. Incl. fittings and rubber mat. Excl. tubes	Panel depth mm	Browser height mm	Browser depth mm	No. of dividers	Item no. Fixed	Price EUR	Item no. Pull-out	Price EUR
 	300	100	300 ^{*1}	0	BN55073100	250,50	BN55273500	457,00
	300	100	300	1	BN55073101	265,40	BN55273501	471,70
	300	100	300	2	BN55073102	278,70	BN55273502	485,90
	300	100	300	4	BN55073104	308,30	BN55273504	514,50

Single browser - without/with pull-out

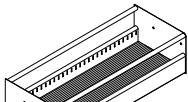
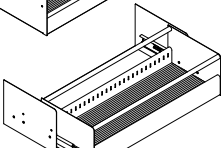
Module 750 mm. Incl. fittings, rubber mat and tubes.	Panel depth mm	Browser height mm	Browser depth mm	No. of dividers	Item no. Fixed	Price EUR	Item no. Pull-out	Price EUR
 	300	200	300 ^{*2}	0	BN55073200	330,00	BN55273600	536,10
	300	200	300	1	BN55073201	346,70	BN55273601	553,40
	300	200	300	2	BN55073202	362,90	BN55273602	570,40
	300	200	300	4	BN55073204	397,00	BN55273604	604,00

Single browser - without/with pull-out

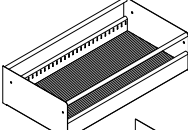
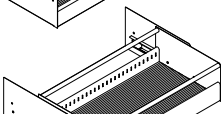
Module 750 mm. Incl. fittings, rubber mat and tubes.	Panel depth mm	Browser height mm	Browser depth mm	No. of dividers	Item no. Fixed	Price EUR	Item no. Pull-out	Price EUR
 	300	200	400 ^{*3}	0	BN55073300	340,10		
	300	200	400	1	BN55073301	356,70		
	300	200	400	2	BN55073302	373,70		
	300	200	400	4	BN55073304	407,20		
	400	200	400	0	BN55074300	340,10	BN55274700	546,80
	400	200	400	1	BN55074301	356,70	BN55274701	563,50
	400	200	400	2	BN55074302	373,70	BN55274702	580,70
	400	200	400	4	BN55074304	407,20	BN55274704	614,60

Double browser - without/with pull-out

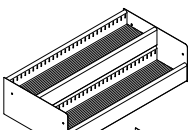
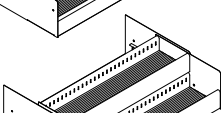
Module 750 mm. Incl. fittings and rubber mat. Excl. tubes	Panel depth mm	Browser height mm	Browser depth mm	No. of dividers	Item no. Fixed	Price EUR	Item no. Pull-out	Price EUR
 	300	200	400 ^{*4}	0	BN55073400	449,30		
	300	200	400	2	BN55073402	473,30		
	300	200	400	4	BN55073404	496,20		
	300	200	400	8	BN55073408	543,60		
	400	200	400	0	BN55074400	449,30	BN55274800	656,10
	400	200	400	2	BN55074402	473,30	BN55274802	679,60
	400	200	400	4	BN55074404	496,20	BN55274804	703,40
	400	200	400	8	BN55074408	543,60	BN55274808	750,10

FUNCTIONS

STEEL BROWSERS

Single browser - without/with pull-out

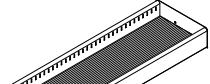
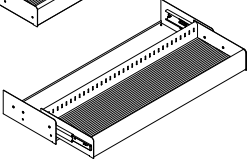
Module 900 mm. Incl. fittings and rubber mat. Excl. tubes	Panel depth mm	Browser height mm	Browser depth mm	No. of dividers	Item no. Fixed	Price	Item no. Pull-out	Price
						EUR		EUR
 	300	100	300 ^{*1}	0	BN55093100	250,50	BN55293500	457,00
	300	100	300	2	BN55093102	278,70	BN55293502	485,90
	300	100	300	4	BN55093104	308,30	BN55293504	514,50
	300	1000	300	5	BN55093105	322,60	BN55293505	529,30

Single browser - without/with pull-out

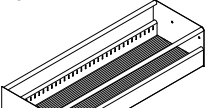
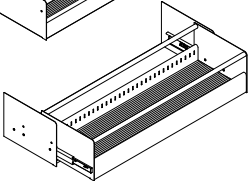
Module 900 mm. Incl. fittings, rubber mat and tubes.	Panel depth mm	Browser height mm	Browser depth mm	No. of dividers	Item no. Fixed	Price	Item no. Pull-out	Price
						EUR		EUR
 	300	200	300 ^{*2}	0	BN55093200	330,00	BN55293600	536,10
	300	200	300	2	BN55093202	362,90	BN55293602	570,40
	300	200	300	4	BN55093204	397,00	BN55293604	604,00
	300	200	300	5	BN55093205	414,20	BN55293605	620,90

Single browser - without/with pull-out

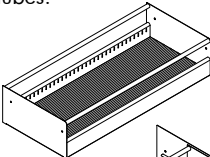
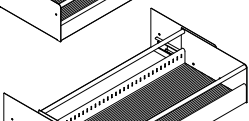
Module 900 mm. Incl. fittings, rubber mat and tubes.	Panel depth mm	Browser height mm	Browser depth mm	No. of dividers	Item no. Fixed	Price	Item no. Pull-out	Price
						EUR		EUR
 	300	200	400 ^{*3}	0	BN55093300	340,10		
	300	200	400	2	BN55093302	373,70		
	300	200	400	4	BN55093304	407,20		
	300	200	400	5	BN55093305	424,10		
	400	200	400	0	BN55094300	340,10		
	400	200	400	2	BN55094302	373,70	BN55294702	580,70
	400	200	400	4	BN55094304	407,20	BN55294704	614,60
	400	200	400	5	BN55094305	424,10	BN55294705	631,00

Double browser - without/with pull-out

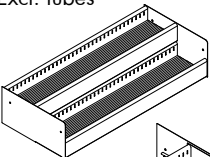
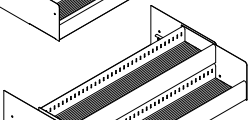
Module 900 mm. Incl. fittings and rubber mat. Excl. tubes	Panel depth mm	Browser height mm	Browser depth mm	No. of dividers	Item no. Fixed	Price	Item no. Pull-out	Price
						EUR		EUR
 	300	200	400 ^{*4}	0	BN55093400	449,30		
	300	200	400	4	BN55093404	496,20		
	300	200	400	8	BN55093408	543,60		
	300	200	400	10	BN55093410	566,60		
	400	200	400	0	BN55094400	449,30		
	400	200	400	4	BN55094404	496,20	BN55294804	703,40
	400	200	400	8	BN55094408	543,60	BN55294808	750,10
	400	200	400	10	BN55094410	566,60	BN55294810	773,40

FUNCTIONS

STEEL BROWSERS

Single AV steel browser - for shelf

H100 mm. Lacquered steel browser and dividers with black flocked steel rods. Rubber mat and 2-5 moveable dividers incl. To be fastened onto existing 250 or 300 mm deep steel or wooden shelf without backedge.

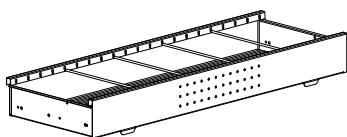

Module	Shelf depth mm	No. of dividers	Item no.	Price EUR
500	250	2	B405085552102	190,60
500	300	2	B405085553102	199,00
500	400	2	B405085554102	208,80
750	250	3	B405085572103	220,30
750	300	3	B405085573102	223,70
750	400	3	B405085574103	240,70
900	250	4	B405085592104	228,10
900	300	4	B405085593104	238,50
900	400	4	B405085594104	250,30
1000	250	5	B405085512105	233,20
1000	300	5	B405085513105	244,00
1000	400	5	B405085514105	256,10

Single AV steel browser - fixed

H100 mm. Lacquered steel browser and dividers with black flocked steel rods. Rubber mat and 2-5 moveable dividers incl.

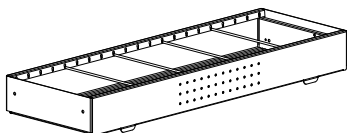

Module	Shelf depth mm	No. of dividers	Item no.	Price EUR
500	250	2	B405085552302	243,70
500	300	2	B405085553302	265,00
500	400	2	B405085554302	278,00
750	250	3	B405085572303	273,20
750	300	3	B405085573303	294,80
750	400	3	B405085574303	309,70
900	250	4	B405085592304	281,40
900	300	4	B405085593304	304,00
900	400	4	B405085594304	319,20
1000	250	5	B405085512305	286,50
1000	300	5	B405085513305	309,40
1000	400	5	B405085514305	324,80

FUNCTIONS

STEEL BROWSERS

For safety reasons only load the the browsers with pull-out function with a maximum of 15 kg. Only install a maximum of 3 pull-out browsers on single-sided shelving and 1 pull-out browsers on each side of a double-sided shelving. Shelving with castors should not have pull-out browsers installed. The lowest browser must be at least 50 cm above the floor to prevent being used as a step.

Single AV steel browser - with pull-out

H100 mm. Lacquered steel browser and dividers with black flocked steel rods. Rubber mat and 2-5 moveable dividers incl. With handle for pull-out function on telescopic rails.

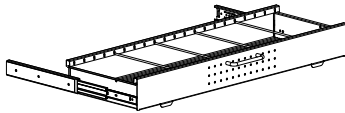

Module	Shelf depth mm	No. of dividers	Item no.	Price EUR
500	250	2	B405085552502	327,30
500	300	2	B405085553502	348,30
500	400	2	B405085554502	365,60
750	250	3	B405085572503	356,90
750	300	3	B405085573503	378,40
750	400	3	B405085574503	397,50
900	250	4	B405085592504	365,00
900	300	4	B405085593504	387,50
900	400	4	B405085594504	406,90
1000	250	5	B405085512505	369,90
1000	300	5	B405085513505	393,00
1000	400	5	B405085514505	412,70

Single AV steel browser - pull-out and soft closing

H100 mm. Lacquered steel browser and dividers with black flocked steel rods. Rubber mat and 2-5 moveable dividers incl. With handle for pull-out function on telescopic rails.

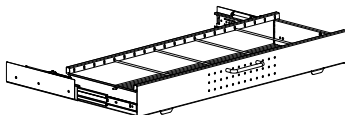

Module	Shelf depth mm	No. of dividers	Item no.	Price EUR
500	250	2	B405085552702	358,80
500	300	2	B405085553702	379,80
500	400	2	B405085554702	398,80
750	250	3	B405085572703	388,70
750	300	3	B405085573703	410,20
750	400	3	B405085574703	430,80
900	250	4	B405085592704	396,40
900	300	4	B405085593704	419,00
900	400	4	B405085594704	440,00
1000	250	5	B405085512705	401,30
1000	300	5	B405085513705	424,30
1000	400	5	B405085514705	445,60

FUNCTIONS

STEEL BROWSERS

Divider for single-/double browser

Additional steel divider.
Chromed steel.

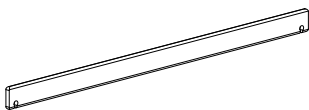

Type	Height mm	Shelf depth mm	Item no.	Price EUR
Single	100	300	B4011603	17,00
Single	200	300	B4011603	17,00
Single	200	400	B4011604	19,70
Double	200	400	B4011601	13,70

Divider for AV steel browser

Additional lacquered steel divider with
flocked steel rod.

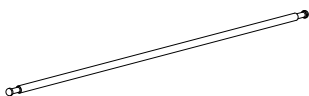

Shelf depth mm	Item no.	Price EUR
250	B4010702	32,60
300	B4010703	32,60
400	B4010704	32,60

FUNCTIONS

STEEL BROWSERS

Capacity examples for 750 mm fixed single/double browser (see page 168)

	Type	Module	H x D mm	CD cases	DVD cases	CD pockets	Picture books	Comic picture books
				5 rows	5 rows	5 rows	3 rows	2 rows
*1	Single	750	100 x 300	100	75	325	-	-
*2	Single	750	200 x 300	100	75	325	90	40
*3	Single	750	200 x 400	150	105	325	120	50
				2 x 5 rows	2 x 5 rows	2 x 5 rows	3 rows	2 rows
*4	Double	750	200 x 400	130	95	400	-	-

Capacity examples for 750 mm single/double browser with pull-out (see page 168)

	Type	Module	H x D mm	CD cases	DVD cases	CD pockets	Picture books	Comic picture books
				5 rows	5 rows	5 rows	3 rows	2 rows
*1	Single	750	100 x 300	80	60	260	-	-
*2	Single	750	200 x 300	80	60	260	90	40
*3	Single	750	200 x 400	120	84	340	120	50
				2 x 5 rows	2 x 5 rows	2 x 5 rows	3 rows	2 rows
*4	Double	750	200 x 400	104	76	320	-	-

Capacity examples for 900 mm fixed single/double browser (see page 169)

	Type	Module	H x D mm	CD cases	DVD cases	CD pockets	Picture books	Comic picture books
				6 rows	6 rows	6 rows	4 rows	3 rows
*1	Single	900	100 x 300	120	90	390	-	-
*2	Single	900	200 x 300	120	90	390	120	60
*3	Single	900	200 x 400	180	126	510	180	75
				2 x 6 rows	2 x 6 rows	2 x 6 rows	4 rows	3 rows
*4	Double	900	200 x 400	156	114	480	-	-

Capacity examples for 900 mm single/double browser with pull-out (see page 169)

	Type	Module	H x D mm	CD cases	DVD cases	CD pockets	Picture books	Comic picture books
				6 rows	6 rows	6 rows	4 rows	3 rows
*1	Single	900	100 x 300	100	75	325	-	-
*2	Single	900	200 x 300	100	75	325	120	60
*3	Single	900	200 x 400	150	105	425	160	75
				2 x 6 rows	2 x 6 rows	2 x 6 rows	4 rows	3 rows
*4	Double	900	200 x 400	130	95	400	-	-

Capacity examples for 500/750/900/1000 mm AV steel browser (see page 170-171)

Module	Depth mm	CD/DVD cases		Module	Depth mm	CD/DVD cases
500	250	60		500	300	72
750	250	80		750	300	96
900	250	100		900	300	120
1000	250	120		1000	300	144

FUNCTIONS

WOODEN BROWSER

Wooden picture book browser with 4 adjustable compartments (FSC)

W900 x H220/120 x D300 mm.
Incl. 3 dividers and fittings.

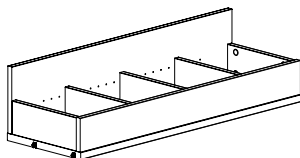

Finish

Item no.

Price
EUR

Painted

BN5107

687,40

Veneer

BN5102

961,80

Wooden CD/DVD browser with 5 adjustable compartments (FSC)

W900 x H170/130 x D300 mm. Incl. 4 dividers and pull out frame with 100% expansion.

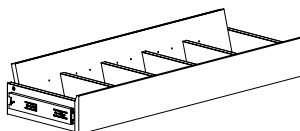

Finish

Item no.

Price
EUR

Painted

B7840045

1.384,20

Veneer

B7840041

1.936,80

FUNCTIONS

DISPLAY & STORAGE

Wooden newspaper cassette with 8 acrylic compartments (FSC)

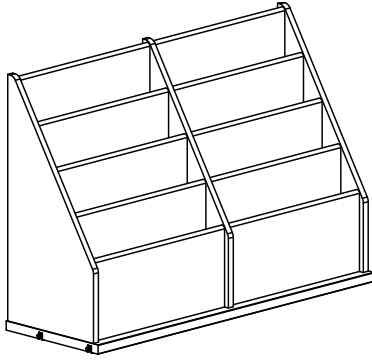

Module mm	Depth mm	Finish	Item no.	Price EUR
900	300	Melamine	BN5286	1.538,80
900	300	Painted	BN5287	1.810,40
900	300	Veneer	BN5282	2.534,40

FUNCTIONS

DISPLAY & STORAGE

If the steel magazine display is placed at the bottom of the shelving and equipped with either plinth or castors, we recommend ordering a D400 mm shelf as bottom shelf, as the shelf inside the magazine display is only D300 mm.

Steel magazine display - with 1 tip up sloping shelf

Incl. fittings. H400 mm.
For storage of horizontally piled magazines or vertical binders (up to 320 mm in height).

Module mm	Depth mm
900	300
900	400

Item no.	Price EUR
BN5023	473,90
BN5024	473,90

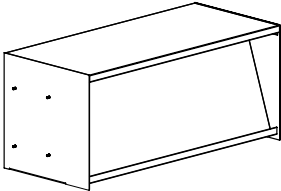

Steel magazine display - with 1 tip up sloping shelf and moveable dividers

Incl. fittings. H400 mm. For separate storage of horizontally piled magazines or vertical binders (up to 320 mm in height). Dividers can be moved 50 mm either way.

Module mm	Depth mm
900	300
900	400

Item no.	Price EUR
BN5043	556,60
BN5044	556,60

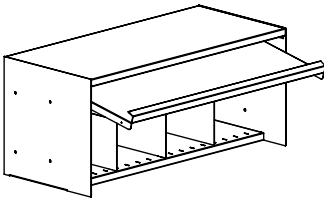

Steel magazine display - with 3 tip up sloping shelves

Incl. fittings. H400 mm. For separate storage of either magazines piled horizontally or vertical binders (up to 320 mm in height).

Module mm	Depth mm
900	300
900	400

Item no.	Price EUR
BN5063	587,80
BN5064	587,80

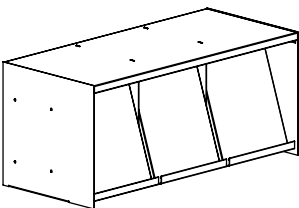

FUNCTIONS

DISPLAY & STORAGE

Steel magazine box - Unibox

H320 x D260 x W320 mm. Box and flap lacquered steel. With transparent antireflex foil. Recommended for use on D250 mm steel shelf with/without backedge and wooden shelf without backedge. Can be used on D300 mm shelves. With space for storage of magazines piled horizontally 140 mm.

Design	Back wall	Item no.	Price EUR
Plain	Yes	B405502001	217,50
Plain	No	B405502000	198,40
With holes	Yes	B405502051	227,20
With holes	No	B405502050	208,30
With slots	Yes	B405502101	238,80
With slots	No	B405502100	219,80

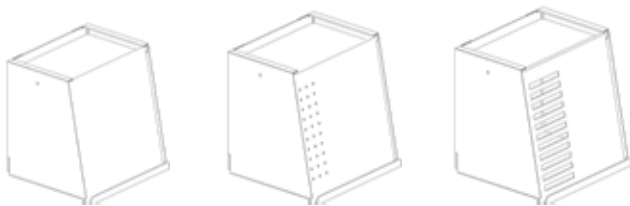

Steel magazine box

H320 x D260 x W238 mm. Box and flap lacquered steel. Recommended for use on D250 mm steel shelf with/without backedge and wooden shelf without backedge. Can be used on D300 mm shelves. Upright storage of magazines. With space for storage of magazines piled vertically 140 mm.

Item no.	Price EUR
B405504	243,90

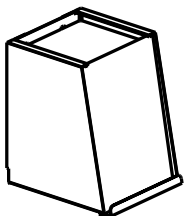

Steel magazine flap

H340 mm (without shelf). Lacquered steel. Min. height between shelves must be 327 mm. To be screwed into panels. Effective lever mechanism keeps the open flap up. Easily retrofitted for single- and double-sided shelves. Recommended to use with back panels. With space for storage of magazines piled horizontally 160 mm.

Module mm	Depth mm	Item no.	Price EUR
500	250	BN50025	187,20
500	300	BN50035	192,00
500	400	BN50045	205,00
750	250	BN50027	210,10
750	300	BN50037	214,10
750	400	BN50047	228,10
900	250	BN50029	221,30
900	300	BN50039	225,40
900	400	BN50049	236,80
1000	250	BN50021	232,50
1000	300	BN50031	236,30
1000	400	BN50041	248,00

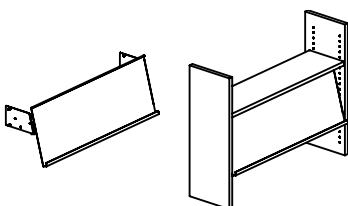

FUNCTIONS

DISPLAY & STORAGE - FOR SHELVES

Steel magazine display

H300 mm. With slanted back and additional side stop. A double front edge keeps this collector flush with the front edge of the shelf. With slip stop to prevent the display from slipping on steel shelves.

Size	Width mm
DIN A4	220
DIN A3	440

Item no.	Price EUR
B4055064	45,20
B4055063	77,80

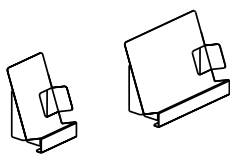

Steel magazine divider

H300 x W95 x D240 mm. Single, slanted element connectable side by side via plug-in connections. For bay W700 mm, use 6 dividers. For bay W900 mm, use 8 dividers. For bay W1000 mm, use 9 dividers.

Size
DIN A4

Item no.	Price EUR
B405508	39,50

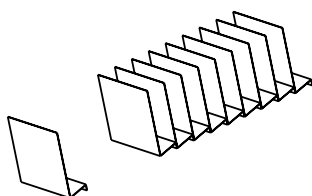

Steel U-storage

H250 x W145 x D220 mm.
Multi-functional storage use.

Item no.	Price EUR
B405510	54,10

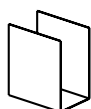

FUNCTIONS

DISPLAY & STORAGE - FOR SHELVES

Plastic periodical collector

H325 x W80 x D230 mm. Light grey plastic. Multi-functional storage use. With front-edge for easy guidance along shelf.

Item no.	Price EUR
B4056016	20,60



Steel slanted CD tray

H120 x W150 x D220 mm. With anti-slipping feet. Rubber mat to be ordered separately.

Approx. capacity	Item no.	Price EUR
20 CD's	B405536	71,60
Rubber mat	B405538	9,30

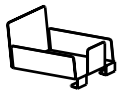

FUNCTIONS

BOOK SUPPORTS

Backedge book support - for S1

Nickel plated steel, Ø6 mm,
with a nylon glider.

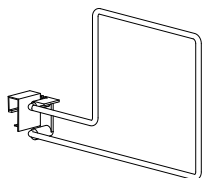

Height mm	Shelf depth mm	Type	Item no.	Price EUR
163	250	For books on left side of book support	B4011221	18,90
163	300	For books on left side of book support	B4011222	20,40
243	250/300	For books on left side of book support	B4011223	26,50
163	250	For books on right side of book support	B4011224	18,90
163	300	For books on right side of book support	B4011225	20,40

Hanging book support - for S2 and W2/4 with rail

Available in chrome steel or
standard steel colours.

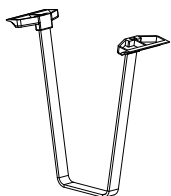

Height mm	Item no.	Price EUR
200	B4011242	10,10
250	B4011245	10,90

Rail for fixing hanging book support under W2 & W4

Fix underneath wooden shelf.
For book support B40112x.
Incl. fittings

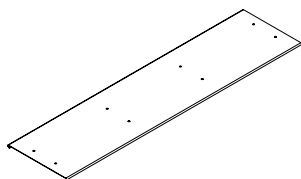

Module	Item no.	Price EUR
750	B4022007	36,30
900	B4022009	36,30

Hanging book support - for S3, S4 & ST3

Chromed round steel with
unbreakable plastic sliders.
Easy adjustable.

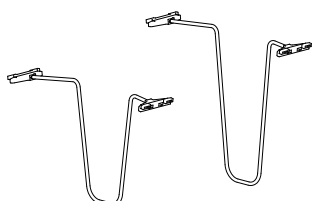

Height mm	Shelf depth mm	Item no.	Price EUR
220	250	B40553032	11,30
220	300	B40553033	12,00
280	250	B40553062	12,60
280	300	B40553063	13,60

FUNCTIONS

BOOK SUPPORTS

Divider for hanging book support

H250 x D240 mm. White plastic. For sliding onto hanging book support B405530. The divider rests upon the shelf. Is ideal for loose-leaf material, brochures, music books etc.

Item no.	Price EUR
B40553152	34,40



Steel angled book support

W150 x H150 x D150 mm.

Item no.	Price EUR
B401120	11,60

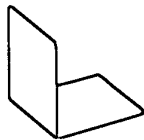

Steel angled book support

W120 x D150 mm.

Height
mm

Item no. Price
EUR

175
240

B4055321 11,20
B4055324 12,40

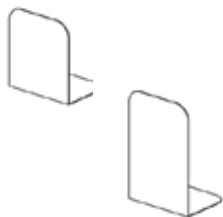

Steel angled book support - with shelf attachment

W150 x H200 x D150 mm.
Attaches onto front of shelf.
With or without letter tag.

Height
mm

Books left/right of
book support

With/without
letter tag

Item no. Price
EUR

200
200

Right
Left

Without
Without

B40553490 16,70
B40553480 16,70

200
200

Right
Left

With
With

B40553491 20,30
B40553481 20,30

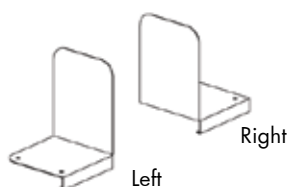

FUNCTIONS

SIGNAGE FOR FRONT OF STEEL AND WOODEN SHELVES

Plastic clip-on label holder - for S1/ST1 with 25 mm frontedge

H25 mm. Incl. white label. Can glide along shelf.

Width
mm
220

Item no.
B401135

Price
EUR
11,00

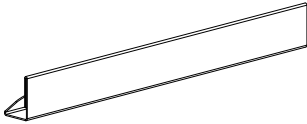

Plastic clip-on label holder - for S2/ST2

H25 mm. Incl. white label. Can glide along shelf.

Width
mm
213

Item no.
E3381

Price
EUR
-

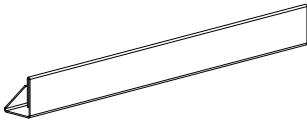

Plastic clip-on label holder - for S3/S4/W3/W4/WB3/WB4

H21 mm. Transparent, antireflective plastic. Incl. white label. Clips into groove underneath steel or wooden shelf. Can glide along shelf.

Width-
mm
105 Plastic clip-on label holder
210 Plastic clip-on label holder
104 White sheet w. 13 labels (spare part)
209 White sheet w. 13 labels (spare part)

Item no.
B4017102
B4017106
B4017111
B4017116

Price
EUR
4,80
5,30
0,90
0,90

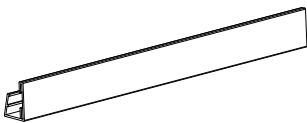

Plastic clip-on label holder - for ST3 & S4

H50 mm. Transparent, antireflective plastic. Incl. white label. Clips into groove underneath steel or wooden shelf. Can glide along shelf.

Module
mm
500 Plastic clip-on label holder
750 Plastic clip-on label holder
900 Plastic clip-on label holder
1000 Plastic clip-on label holder
500 Label (spare part)
750 Label (spare part)
900 Label (spare part)
1000 Label (spare part)

Item no.
B40114455
B40114457
B40114459
B40114451
B40114555
B40114557
B40114559
B40114551

Price
EUR
32,70
32,70
32,70
32,70
1,80
1,80
1,80
1,80

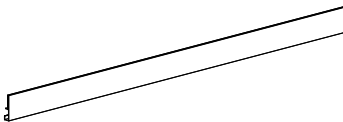

FUNCTIONS

SIGNAGE FOR FRONT OF STEEL AND WOODEN SHELVES

Self-adhesive plastic label holder - for S1/S2/S3/S4/ST1/ST2/ST3

H20 mm. Transparent, antireflective plastic. Incl. white label.	Width mm		Item no.	Price EUR
	147		B4017124	1,40
	200		B4017125	2,10

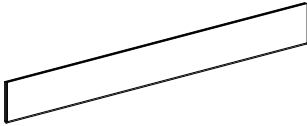

Magnetic plastic label holder - for S1/S2/S3/S4/ST2/ST3

H20 mm. Transparent, antireflective plastic. Incl. white label. Attach to steel shelves with smooth edge.	Width mm		Item no.	Price EUR
	210	Self-adhesive plastic label holder	B4017147	11,30
	209	White sheet w. 13 labels (spare part)	B4017116	0,90

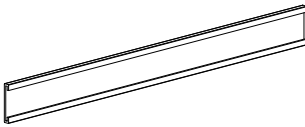

Magnetic shelf label - for ST1 with 47 mm frontedge

H40 mm. Black. Attach to steel shelves with smooth edge.	Width mm		Item no.	Price EUR
	300		B4000020300	12,70

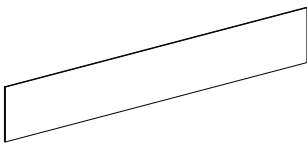

Steel label holder

H26 x W150 x D150 mm. Steel with transparent, antireflective plastic. Incl. white label. Universal use, simply place on shelf where needed.			Item no.	Price EUR
			B401801	11,30

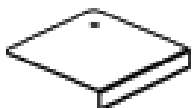

FUNCTIONS

SIGNAGE FOR END PANEL

End panel signage for wooden end panel - flat

Fastened to the end panel with screws. The sign has an acrylic film for insertion of text slide.

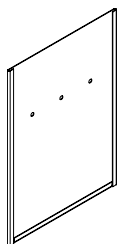

Format	Item no.	Price EUR
A4 vertical/upright format	B40110377	41,10
A3 vertical/upright format	B40110378	54,80
A3 horizontal format	B40110379	54,80

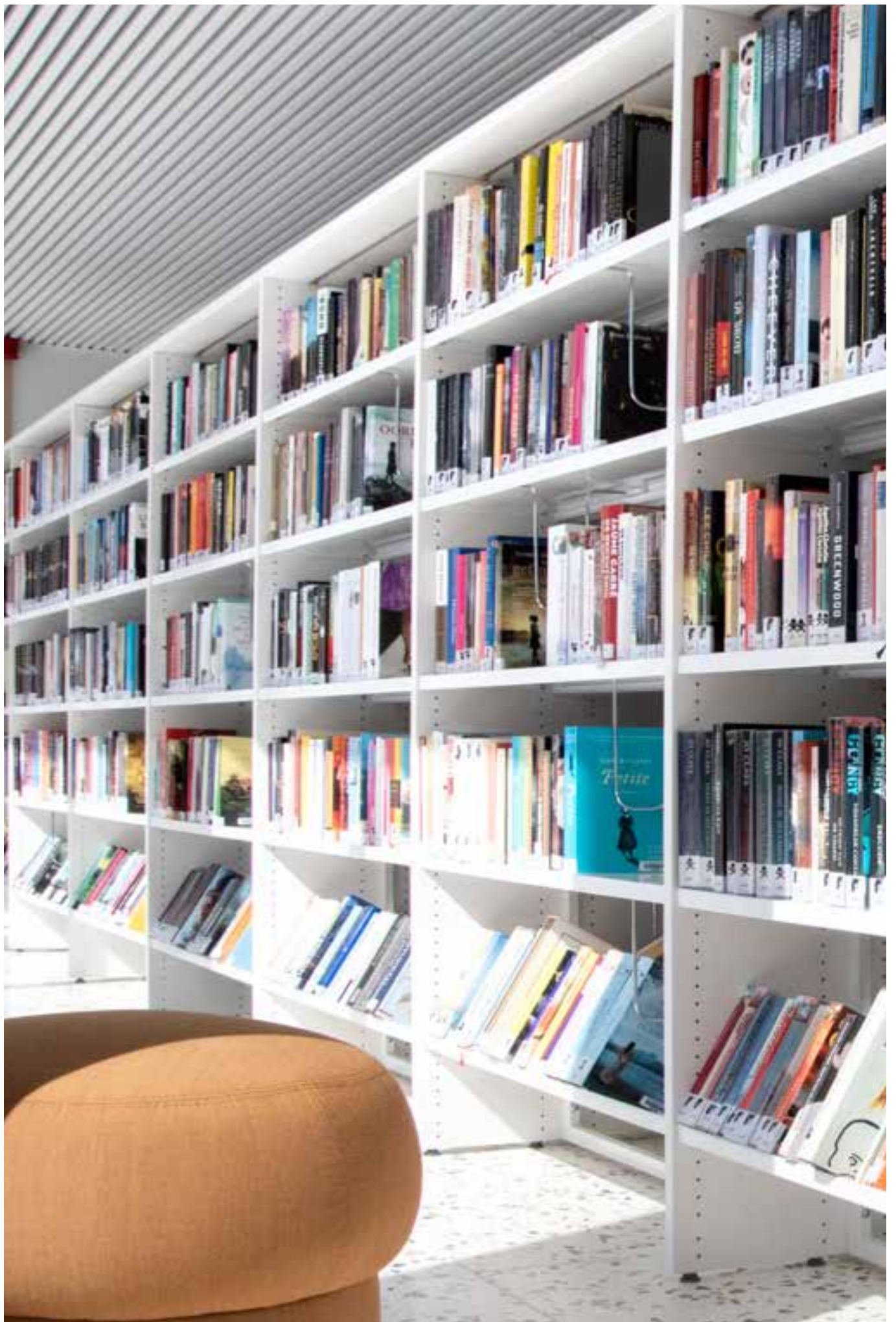

CASTORS

CASTOR FRAME & CASTOR PLATE



CASTORS

CASTOR FRAME & CASTORS

We recommend having a maximum of 3 adjoining bays mounted on castors.

Castor frame set with visible castors

A set of 2 frames and 4 Ø75 mm castors. To be used with double-sided panels WP1, WP2, WP3, WP4 and back panels WPB1/WBP2. Max. height 1520 mm. Order at least one castor frame with brakes.

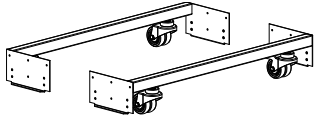

Module mm	x castors with brake	Item no.	Price EUR
500	0	BN06050	284,90
500	2	BN06051	302,30
750	0	BN06070	383,20
750	2	BN06071	400,40
900	0	BN06090	383,20
900	2	BN06091	400,40
1000	0	BN06010	416,00
1000	2	BN06011	433,30

Castors for visible castor frame set

Spare part. H112 mm, Ø75 mm. Max 90 kg. per castor.

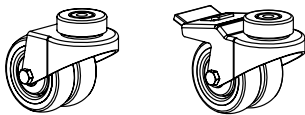

Type	Item no.	Price EUR
Without brake	B7860100	120,40
With brake	B7860101	145,80

Castor frame set with hidden castors and steel plinth

A set of 2 frames, 4 x Ø35 mm castors without brakes and 2 steel plinths. To be used with double-sided panels WP1, WP2, WP3, WP4 and back panels WPB1/WBP2. Max. height 1520 mm.

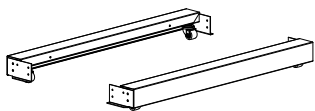

Module mm	Item no.	Price EUR
500	BN0615	452,00
750	BN0617	452,00
900	BN0619	452,00
1000	BN0611	485,40

Castors for hidden castor frame set

H50 mm, Ø35 mm. Spare part. Max. 100 kg per castor.

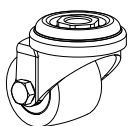

Type	Item no.	Price EUR
Without brake	B301017	64,40

CASTORS

CASTOR PLATES

Painted and veneered castor plates are FSC-certified.

Double-sided wooden castor plate

With 4/6/8 Ø75 mm castors, 2 of which are with brakes. To be used with double-sided panels for castor plate WP5/WP6/WP7/WP8 and WPB3/WBP4. Max. height 1520 mm.

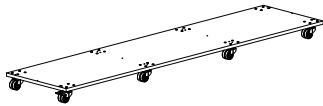

Module mm	Depth mm	No of bays	Item no.	Melamine EUR	Painted EUR	Veneer EUR
500	250	1	BN050451.	267,90	315,00	441,20
500	250	2	BN050452.	401,40	472,30	661,60
500	250	3	BN050453.	602,40	708,50	991,50
500	300	1	BN050651.	297,20	349,60	490,10
500	300	2	BN050652.	446,10	525,00	734,90
500	300	3	BN050653.	669,40	787,30	1.102,10
500	400	1	BN050851.	327,30	385,10	538,70
500	400	2	BN050852.	490,70	577,40	808,20
500	400	3	BN050853.	736,30	866,00	1.212,50
750	250	1	BN050471.	401,40	472,30	661,60
750	250	2	BN050472.	602,40	708,50	991,50
750	250	3	BN050473.	903,50	1.062,80	1.487,40
750	300	1	BN050671.	446,10	525,00	734,90
750	300	2	BN050672.	669,40	787,30	1.102,10
750	300	3	BN050673.	1.004,00	1.181,00	1.653,50
750	400	1	BN050871.	490,70	577,40	808,20
750	400	2	BN050872.	736,30	866,00	1.212,50
750	400	3	BN050873.	1.104,00	1.299,20	1.818,60
900	250	1	BN050491.	481,90	567,10	793,70
900	250	2	BN050492.	722,80	850,20	1.190,40
900	300	1	BN050691.	535,40	629,80	881,50
900	300	2	BN050692.	803,10	944,80	1.322,70
900	400	1	BN050891.	588,70	692,50	970,20
900	400	2	BN050892.	883,40	1.039,30	1.454,80
1000	250	1	BN050411.	535,40	629,80	881,50
1000	250	2	BN050412.	803,10	944,80	1.322,70
1000	300	1	BN050611.	595,00	699,90	979,20
1000	300	2	BN050612.	892,00	1.049,70	1.469,60
1000	400	1	BN050811.	654,00	769,50	1.077,60
1000	400	2	BN050812.	981,50	1.154,80	1.616,20

Castors for castor plate

Spare part. H102 mm, Ø75 mm. Max 100 kg. per castor.

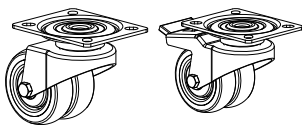

Type	Item no.	Price EUR
Without brake	B400001025	48,60
With brake	B400001125	59,10

PLINTHS

WOODEN & STEEL PLINTHS

Painted and veneered plinths are FSC-certified.

Wooden plinth

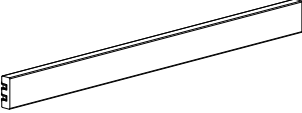
Incl. snapfix. H71 mm. Cannot be used with castors.	Module mm	Item no.	Melamine EUR	Painted EUR	Veneer EUR
	500	BN0255.	55,70	65,50	92,00
	750	BN0257.	70,00	82,70	116,10
	900	BN0259.	70,00	82,70	116,10
	1000	BN0251.	83,00	97,50	136,20

Steel plinth

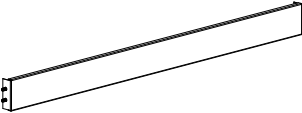
Incl. screws. H71 mm. Cannot be used with castors.	Module mm	Item no.	Steel EUR
	500	BN0275	29,10
	750	BN0277	36,90
	900	BN0279	36,90
	1000	BN0271	43,50

WOODEN PANELS

SINGLE-SIDED - WITH ADJUSTABLE FEET - FOR STEEL AND WOODEN TOP SHELF

Painted and veneered panels are FSC-certified.

WP1 - single-sided, left end panel with adjustable feet - for ST1/ST2/ST3 and WT1

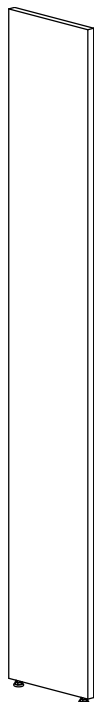

Height mm	Shelf depth mm	Item no.	Melamine EUR	Painted EUR	Veneer EUR
720	250	BN0014232.	127,40	150,10	210,40
720	300	BN0014252.	146,00	171,60	240,70
720	400	BN0014272.	197,90	232,90	326,10
920	250	BN0014332.	163,20	192,10	268,50
920	300	BN0014352.	186,80	219,60	307,80
920	400	BN0014372.	253,00	297,40	416,60
1220	250	BN0014432.	216,10	254,00	356,00
1220	300	BN0014452.	225,50	265,20	371,10
1220	400	BN0014472.	327,10	384,90	538,70
1520	250	BN0014532.	245,60	289,00	404,50
1520	300	BN0014552.	254,80	300,10	419,50
1520	400	BN0014572.	377,10	443,60	620,60
1820	250	BN0014632.	288,00	338,80	474,40
1820	300	BN0014652.	294,70	346,80	485,00
1820	400	BN0014672.	431,40	507,50	710,90
2120	250	BN0014732.	321,00	377,70	528,80
2120	300	BN0014752.	327,10	384,90	538,70
2120	400	BN0014772.	473,30	556,90	779,30

WP1 - single-sided, intermediate panel with adjustable feet - for ST1/ST2/ST3 and WT1

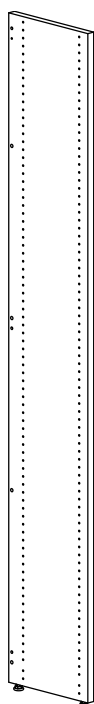

Height mm	Shelf depth mm	Item no.	Melamine EUR	Painted EUR	Veneer EUR
720	250	BN0014234.	127,40	150,10	210,40
720	300	BN0014254.	146,00	171,60	240,70
720	400	BN0014274.	197,90	232,90	326,10
920	250	BN0014334.	163,20	192,10	268,50
920	300	BN0014354.	186,80	219,60	307,80
920	400	BN0014374.	253,00	297,40	416,60
1220	250	BN0014434.	216,10	254,00	356,00
1220	300	BN0014454.	225,50	265,20	371,10
1220	400	BN0014474.	327,10	384,90	538,70
1520	250	BN0014534.	245,60	289,00	404,50
1520	300	BN0014554.	254,80	300,10	419,50
1520	400	BN0014574.	377,10	443,60	620,60
1820	250	BN0014634.	288,00	338,80	474,40
1820	300	BN0014654.	294,70	346,80	485,00
1820	400	BN0014674.	431,40	507,50	710,90
2120	250	BN0014734.	321,00	377,70	528,80
2120	300	BN0014754.	327,10	384,90	538,70
2120	400	BN0014774.	473,30	556,90	779,30

WOODEN PANELS

SINGLE-SIDED - WITH ADJUSTABLE FEET - FOR STEEL AND WOODEN TOP SHELF

Painted and veneered panels are FSC-certified.

WP1 - single-sided right end panel with adjustable feet - for ST1/ST2/ST3 and WT1

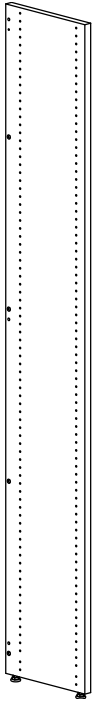

Height mm	Shelf depth mm	Item no.	Melamine EUR	Painted EUR	Veneer EUR
720	250	BN0014233.	127,40	150,10	210,40
720	300	BN0014253.	146,00	171,60	240,70
720	400	BN0014273.	197,90	232,90	326,10
920	250	BN0014333.	163,20	192,10	268,50
920	300	BN0014353.	186,80	219,60	307,80
920	400	BN0014373.	253,00	297,40	416,60
1220	250	BN0014433.	216,10	254,00	356,00
1220	300	BN0014453.	225,50	265,20	371,10
1220	400	BN0014473.	327,10	384,90	538,70
1520	250	BN0014533.	245,60	289,00	404,50
1520	300	BN0014553.	254,80	300,10	419,50
1520	400	BN0014573.	377,10	443,60	620,60
1820	250	BN0014633.	288,00	338,80	474,40
1820	300	BN0014653.	294,70	346,80	485,00
1820	400	BN0014673.	431,40	507,50	710,90
2120	250	BN0014733.	321,00	377,70	528,80
2120	300	BN0014753.	327,10	384,90	538,70
2120	400	BN0014773.	473,30	556,90	779,30

WOODEN PANELS

DOUBLE-SIDED - WITH ADJUSTABLE FEET - FOR STEEL AND WOODEN TOP SHELF

Painted and veneered panels are FSC-certified.

WP1 - double-sided outer end panel with adjustable feet - for ST1/ST2/ST3 and WT1

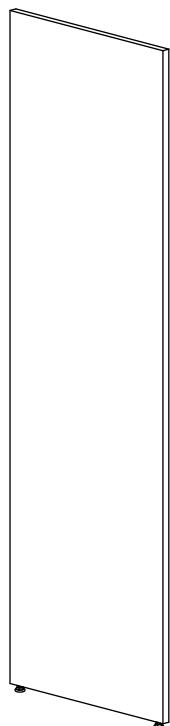

Height mm	Shelf depth mm	Item no.	Melamine EUR	Painted EUR	Veneer EUR
720	250	BN0014245.	186,40	219,20	306,80
720	300	BN0014265.	244,60	287,60	421,30
720	400	BN0014285.	355,40	418,00	585,40
920	250	BN0014345.	238,00	280,00	392,00
920	300	BN0014365.	312,60	367,90	515,10
920	400	BN0014385.	454,10	534,00	747,60
1220	250	BN0014445.	314,00	369,50	517,60
1220	300	BN0014465.	406,20	477,80	669,40
1220	400	BN0014485.	590,30	694,50	972,70
1520	250	BN0014545.	350,70	412,50	577,20
1520	300	BN0014565.	427,90	503,40	705,20
1520	400	BN0014585.	621,40	731,20	1.023,70
1820	250	BN0014645.	413,50	486,70	681,80
1820	300	BN0014665.	505,50	595,00	832,80
1820	400	BN0014685.	735,30	865,20	1.211,70
2120	250	BN0014745.	467,20	549,50	769,70
2120	300	BN0014765.	580,50	683,10	956,30
2120	400	BN0014785.	844,90	993,60	1.391,30

WP1 - double-sided intermediate panel with adjustable feet - for ST1/ST2/ST3 and WT1

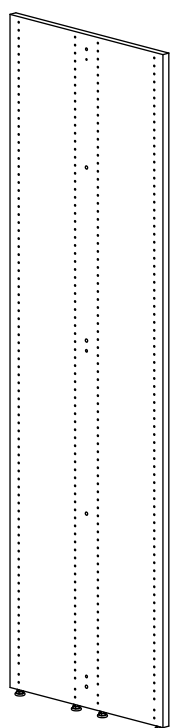

Height mm	Shelf depth mm	Item no.	Melamine EUR	Painted EUR	Veneer EUR
720	250	BN0014244.	186,40	219,20	306,80
720	300	BN0014264.	244,60	287,60	402,90
720	400	BN0014284.	355,40	418,00	585,40
920	250	BN0014344.	238,00	280,00	392,00
920	300	BN0014364.	312,60	367,90	515,10
920	400	BN0014384.	454,10	534,00	747,60
1220	250	BN0014444.	314,00	369,50	517,60
1220	300	BN0014464.	406,20	477,80	669,40
1220	400	BN0014484.	590,30	694,50	972,70
1520	250	BN0014544.	350,70	412,50	577,20
1520	300	BN0014564.	427,90	503,40	705,20
1520	400	BN0014584.	621,40	731,20	1.023,70
1820	250	BN0014644.	413,50	486,70	681,80
1820	300	BN0014664.	505,50	595,00	832,80
1820	400	BN0014684.	735,30	865,20	1.211,70
2120	250	BN0014744.	467,20	549,50	769,70
2120	300	BN0014764.	580,50	683,10	956,30
2120	400	BN0014784.	844,90	993,60	1.391,30

WOODEN PANELS

DOUBLE-SIDED - WITH ADJUSTABLE FEET - FOR STEEL AND WOODEN TOP SHELF

Painted and veneered panels are FSC-certified.

WP2 - double-sided slat outer end panel with milled slat - with adjustable feet - for ST1/ST2/ST3 and WT1

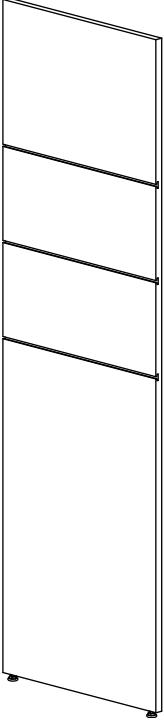
H1520 has 2 slats, H1820 and 2120 has 3 slats.	Height mm	Shelf depth mm	Item no.	Melamine EUR	Painted EUR	Veneer EUR
	1520	250	BN0455451.		662,60	927,60
	1520	300	BN0455651.		754,10	1.055,40
	1520	400	BN0455851.		867,20	1.213,60
	1820	250	BN0456451.		748,00	1.047,40
	1820	300	BN0456651.		861,50	1.206,20
	1820	400	BN0456851.		990,50	1.386,80
	2120	250	BN0457451.		863,90	1.209,90
	2120	300	BN0457651.		989,70	1.385,40
	2120	400	BN0457851.		1.138,00	1.593,30

WOODEN PANELS

SINGLE-SIDED - WITH ADJUSTABLE FEET - WITH OVERLAYING TOP PLATE

Painted and veneered panels are FSC-certified.

WP3 - single-sided left end panel with adjustable feet - for WO1

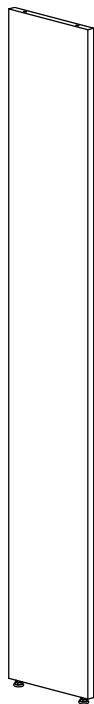

Height mm	Shelf depth mm	Item no.	Melamine EUR	Painted EUR	Veneer EUR
720	250	BN0014236.	127,40	150,10	210,40
720	300	BN0014256.	146,00	171,60	240,70
720	400	BN0014276.	197,90	232,90	326,10
920	250	BN0014336.	163,20	192,10	268,50
920	300	BN0014356.	186,80	219,60	307,80
920	400	BN0014376.	253,00	297,40	416,60
1220	250	BN0014436.	216,10	254,00	356,00
1220	300	BN0014456.	225,50	265,20	371,10
1220	400	BN0014476.	327,10	384,90	538,70
1520	250	BN0014536.	245,60	289,00	404,50
1520	300	BN0014556.	254,80	300,10	419,50
1520	400	BN0014576.	377,10	443,60	620,60
1820	250	BN0014636.	288,00	338,80	474,40
1820	300	BN0014656.	294,70	346,80	485,00
1820	400	BN0014676.	431,40	507,50	710,90
2120	250	BN0014736.	321,00	377,70	528,80
2120	300	BN0014756.	327,10	384,90	538,70
2120	400	BN0014776.	473,30	556,90	779,30

WP3 - single-sided intermediate panel with adjustable feet - for WO1

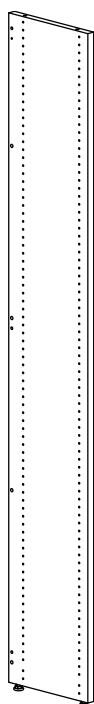

Height mm	Shelf depth mm	Item no.	Melamine EUR	Painted EUR	Veneer EUR
720	250	BN0014238.	127,40	150,10	210,40
720	300	BN0014258.	146,00	171,60	240,70
720	400	BN0014278.	197,90	232,90	326,10
920	250	BN0014338.	163,20	192,10	268,50
920	300	BN0014358.	186,80	219,60	307,80
920	400	BN0014378.	253,00	297,40	416,60
1220	250	BN0014438.	216,10	254,00	356,00
1220	300	BN0014458.	225,50	265,20	371,10
1220	400	BN0014478.	327,10	384,90	538,70
1520	250	BN0014538.	245,60	289,00	404,50
1520	300	BN0014558.	254,80	300,10	419,50
1520	400	BN0014578.	377,10	443,60	620,60
1820	250	BN0014638.	288,00	338,80	474,40
1820	300	BN0014658.	294,70	346,80	485,00
1820	400	BN0014678.	431,40	507,50	710,90
2120	250	BN0014738.	321,00	377,70	528,80
2120	300	BN0014758.	327,10	384,90	538,70
2120	400	BN0014778.	473,30	556,90	779,30

WOODEN PANELS

SINGLE-SIDED - WITH ADJUSTABLE FEET - WITH OVERLAYING TOP PLATE

Painted and veneered panels are FSC-certified.

WP3 - single-sided right end panel with adjustable feet - for WO1

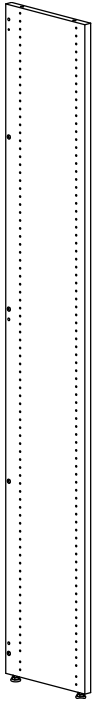

Height mm	Shelf depth mm	Item no.	Melamine EUR	Painted EUR	Veneer EUR
720	250	BN0014237.	127,40	150,10	210,40
720	300	BN0014257.	146,00	171,60	240,70
720	400	BN0014277.	197,90	232,90	326,10
920	250	BN0014337.	163,20	192,10	268,50
920	300	BN0014357.	186,80	219,60	307,80
920	400	BN0014377.	253,00	297,40	416,60
1220	250	BN0014437.	216,10	254,00	356,00
1220	300	BN0014457.	225,50	265,20	371,10
1220	400	BN0014477.	327,10	384,90	538,70
1520	250	BN0014537.	245,60	289,00	404,50
1520	300	BN0014557.	254,80	300,10	419,50
1520	400	BN0014577.	377,10	443,60	620,60
1820	250	BN0014637.	288,00	338,80	474,40
1820	300	BN0014657.	294,70	346,80	485,00
1820	400	BN0014677.	431,40	507,50	710,90
2120	250	BN0014737.	321,00	377,70	528,80
2120	300	BN0014757.	327,10	384,90	538,70
2120	400	BN0014777.	473,30	556,90	779,30

WOODEN PANELS

DOUBLE-SIDED - WITH ADJUSTABLE FEET & OVERLAYING TOP PLATE

Painted and veneered panels are FSC-certified.

WP3 - double-sided outer end panel with adjustable feet - for WO1

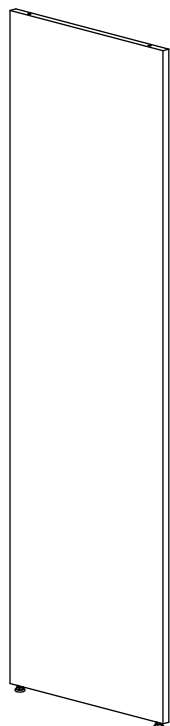

Height mm	Shelf depth mm	Item no.	Melamine EUR	Painted EUR	Veneer EUR
720	250	BN0014249.	186,40	219,20	306,80
720	300	BN0014269.	244,60	287,60	402,90
720	400	BN0014289.	355,40	418,00	585,40
920	250	BN0014349.	238,00	280,00	392,00
920	300	BN0014369.	312,60	367,90	515,10
920	400	BN0014389.	454,10	534,00	747,60
1220	250	BN0014449.	314,00	369,50	517,60
1220	300	BN0014469.	406,20	477,80	669,40
1220	400	BN0014489.	590,30	694,50	972,70
1520	250	BN0014549.	350,70	412,50	577,20
1520	300	BN0014569.	427,90	503,40	705,20
1520	400	BN0014589.	621,40	731,20	1.023,70
1820	250	BN0014649.	413,50	486,70	681,80
1820	300	BN0014669.	505,50	595,00	832,80
1820	400	BN0014689.	735,30	865,20	1.211,70
2120	250	BN0014749.	467,20	549,50	769,70
2120	300	BN0014769.	580,50	683,10	956,30
2120	400	BN0014789.	844,90	993,60	1.391,30

WP3 - double-sided intermediate panel with adjustable feet - for WO1

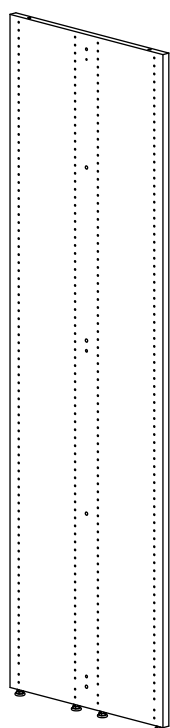

Height mm	Shelf depth mm	Item no.	Melamine EUR	Painted EUR	Veneer EUR
720	250	BN0014248.	186,40	219,20	306,80
720	300	BN0014268.	244,60	287,60	402,90
720	400	BN0014288.	355,40	418,00	585,40
920	250	BN0014348.	238,00	280,00	392,00
920	300	BN0014368.	312,60	367,90	515,10
920	400	BN0014388.	454,10	534,00	747,60
1220	250	BN0014448.	314,00	369,50	517,60
1220	300	BN0014468.	406,20	477,80	669,40
1220	400	BN0014488.	590,30	694,50	972,70
1520	250	BN0014548.	350,70	412,50	577,20
1520	300	BN0014568.	427,90	503,40	705,20
1520	400	BN0014588.	621,40	731,20	1.023,70
1820	250	BN0014648.	413,50	486,70	681,80
1820	300	BN0014668.	505,50	595,00	832,80
1820	400	BN0014688.	735,30	865,20	1.211,70
2120	250	BN0014748.	467,20	549,50	769,70
2120	300	BN0014768.	580,50	683,10	956,30
2120	400	BN0014788.	844,90	993,60	1.391,30

WOODEN PANELS

DOUBLE-SIDED - WITH ADJUSTABLE FEET & OVERLAYING TOP PLATE

Painted and veneered panels are FSC-certified.

WP4 - double-sided slat outer end panel with milled slat and adjustable feet - for WO1

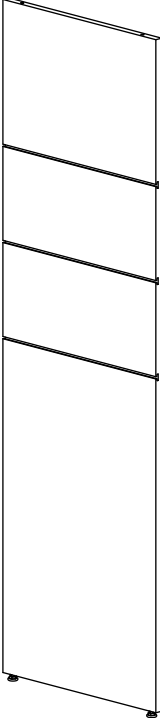
H1520 has 2 slats, H1820 and 2120 has 3 slats.	Height mm	Shelf depth mm	Item no.	Melamine EUR	Painted EUR	Veneer EUR
	1520	250	BN0455491.		662,60	927,60
	1520	300	BN0455691.		754,10	1.055,40
	1520	400	BN0455891.		867,20	1.213,60
	1820	250	BN0456491.		748,00	1.047,40
	1820	300	BN0456691.		861,50	1.206,20
	1820	400	BN0456891.		990,50	1.386,80
	2120	250	BN0457491.		863,90	1.209,90
	2120	300	BN0457691.		989,70	1.385,40
	2120	400	BN0457891.		1.138,00	1.593,30

WOODEN PANELS

DOUBLE-SIDED - FOR CASTOR PLATE & TOP SHELF

Painted and veneered panels are FSC-certified.

WP5 - double-sided outer end panel for castor plate - for ST1/ST2/ST3 and WT1

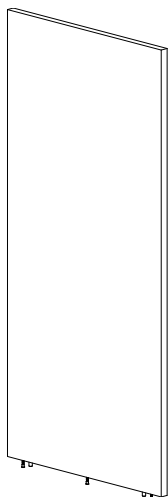

Height mm	Shelf depth mm	Item no.	Melamine EUR	Painted EUR	Veneer EUR
720	250	BN0015245.	186,40	219,20	306,80
720	300	BN0015265.	244,60	287,60	402,90
720	400	BN0015285.	355,40	418,00	585,40
920	250	BN0015345.	238,00	280,00	392,00
920	300	BN0015365.	312,60	367,90	515,10
920	400	BN0015385.	454,10	534,00	747,60
1220	250	BN0015445.	314,00	369,50	517,60
1220	300	BN0015465.	406,20	477,80	669,40
1220	400	BN0015485.	590,30	694,50	972,70
1520	250	BN0015545.	350,70	412,50	577,20
1520	300	BN0015565.	427,90	503,40	705,20
1520	400	BN0015585.	621,40	731,20	1.023,70

WP5 - double-sided intermediate panel for castor plate - for ST1/ST2/ST3 and WT1

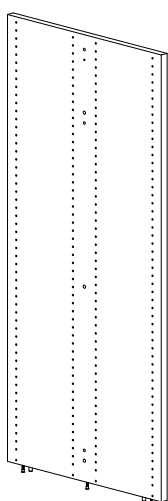

Height mm	Shelf depth mm	Item no.	Melamine EUR	Painted EUR	Veneer EUR
720	250	BN0015244.	186,40	219,20	306,80
720	300	BN0015264.	244,60	287,60	402,90
720	400	BN0015284.	355,40	418,00	585,40
920	250	BN0015344.	238,00	280,00	392,00
920	300	BN0015364.	312,60	367,90	515,10
920	400	BN0015384.	454,10	534,00	747,60
1220	250	BN0015444.	314,00	369,50	517,60
1220	300	BN0015464.	406,20	477,80	669,40
1220	400	BN0015484.	590,30	694,50	972,70
1520	250	BN0015544.	350,70	412,50	577,20
1520	300	BN0015564.	427,90	503,40	705,20
1520	400	BN0015584.	621,40	731,20	1.023,70

WOODEN PANELS

DOUBLE-SIDED - FOR CASTOR PLATE & TOP SHELF

Painted and veneered panels are FSC-certified.

WP6 - double-sided slat outer end panel with milled slats - for castor plate - for ST1/ST2/ST3 and WT1

H1520 has 2 slats.

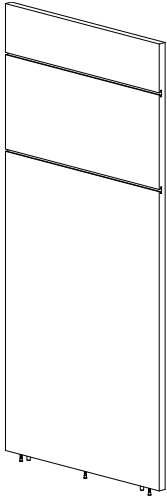

Height mm	Shelf depth mm	Item no.	Melamine EUR	Painted EUR	Veneer EUR
1520	250	BN0465451.		662,60	927,60
1520	300	BN0465651.		754,10	1.055,40
1520	400	BN0465851.		867,20	1.213,60

WOODEN PANELS

DOUBLE-SIDED - FOR CASTOR PLATE & OVERLAYING TOP PLATE

Painted and veneered panels are FSC-certified.

WP7 - double-sided outer end panel for castor plate - for WO1

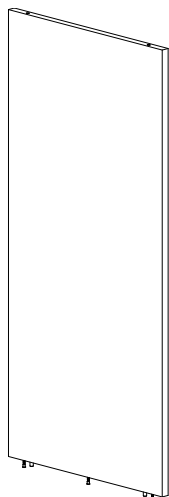

Height mm	Shelf depth mm	Item no.	Melamine EUR	Painted EUR	Veneer EUR
720	250	BN0015249.	186,40	219,20	306,80
720	300	BN0015269.	244,60	287,60	402,90
720	400	BN0015289.	355,40	418,00	585,40
920	250	BN0015349.	238,00	280,00	392,00
920	300	BN0015369.	312,60	367,90	515,10
920	400	BN0015389.	454,10	534,00	747,60
1220	250	BN0015449.	314,00	369,50	517,60
1220	300	BN0015469.	406,20	477,80	669,40
1220	400	BN0015489.	590,30	694,50	972,70
1520	250	BN0015549.	350,70	412,50	577,20
1520	300	BN0015569.	427,90	503,40	705,20
1520	400	BN0015589.	621,40	731,20	1.023,70

WP7 - double-sided intermediate panel for castor plate - for WO1

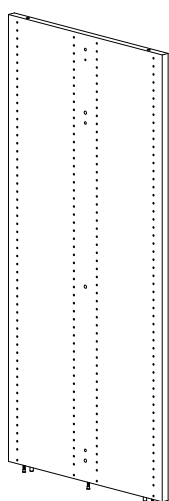

Height mm	Shelf depth mm	Item no.	Melamine EUR	Painted EUR	Veneer EUR
720	250	BN0015248.	186,40	219,20	306,80
720	300	BN0015268.	244,60	287,60	402,90
720	400	BN0015288.	355,40	418,00	585,40
920	250	BN0015348.	238,00	280,00	392,00
920	300	BN0015368.	312,60	367,90	515,10
920	400	BN0015388.	454,10	534,00	747,60
1220	250	BN0015448.	314,00	369,50	517,60
1220	300	BN0015468.	406,20	477,80	669,40
1220	400	BN0015488.	590,30	694,50	972,70
1520	250	BN0015548.	350,70	412,50	577,20
1520	300	BN0015568.	427,90	503,40	705,20
1520	400	BN0015588.	621,40	731,20	1.023,70

WOODEN PANELS

DOUBLE-SIDED - FOR CASTOR PLATE & OVERLAYING TOP PLATE

Painted and veneered panels are FSC-certified.

WP8 - double-sided slat outer end panel with milled slat - for castor plate - for WO1

H1520 has 2 slats.

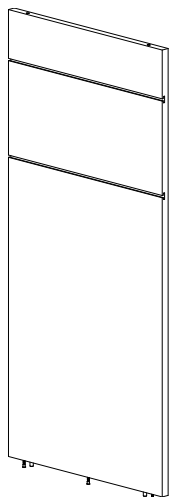

Height mm	Shelf depth mm	Item no.	Melamine EUR	Painted EUR	Veneer EUR
1520	250	BN0465491.		662,60	927,60
1520	300	BN0465691.		754,10	1.055,40
1520	400	BN0465891.		867,20	1.213,60

WOODEN PANELS

WOODEN END PANEL BAYS

Use the panel to create a display area on Lingo shelving system. The end panel bay is easily retrofitted on existing double-sided shelving systems with adjustable feet/castor frame (replace existing end panel with end panel bay).
Painted and veneered panels are FSC-certified.

Wooden end panel bay - for bays with top shelf

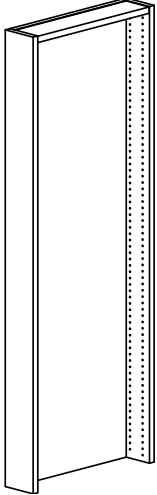
Fastening material included.	Height mm	Shelf depth mm	Width mm	Item no.	Melamine EUR	Painted EUR	Veneer EUR
	720	250	498	BN5402A1.	1.055,60	1.241,80	1.738,70
	720	300	598	BN5402B1.	1.108,30	1.303,90	1.825,60
	720	400	798	BN5402C1.	1.214,00	1.428,20	1.999,50
	920	250	498	BN5403A1.	1.266,80	1.490,10	2.086,30
	920	300	598	BN5403B1.	1.329,90	1.564,60	2.190,80
	920	400	798	BN5403C1.	1.456,70	1.713,70	2.399,30
	1220	250	498	BN5404A1.	1.520,00	1.788,30	2.503,70
	1220	300	598	BN5404B1.	1.596,00	1.877,80	2.628,70
	1220	400	798	BN5404C1.	1.747,90	2.056,60	2.878,90
	1520	250	498	BN5405A1.	1.747,90	2.056,60	2.878,90
	1520	300	598	BN5405B1.	1.835,60	2.159,40	3.023,10
	1520	400	798	BN5405C1.	2.010,10	2.365,10	3.311,10
1820	250	498	BN5406A1.	2.010,10	2.365,10	3.311,10	
1820	300	598	BN5406B1.	2.110,70	2.483,20	3.476,40	
1820	400	798	BN5406C1.	2.311,80	2.719,80	3.807,60	
2120	250	498	BN5407A1.	2.110,70	2.483,20	3.476,40	
2120	300	598	BN5407B1.	2.216,40	2.607,60	3.650,50	
2120	400	798	BN5407C1.	2.427,30	2.855,80	3.998,10	

Wooden end panel bay - for bays with overlaying top plate

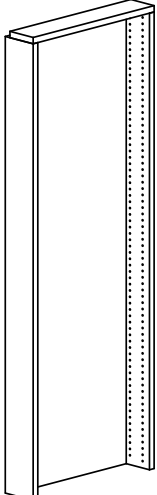
Fastening material included.	Height mm	Shelf depth mm	Width mm	Item no.	Melamine EUR	Painted EUR	Veneer EUR
	720	250	498	BN5402A2.	1.055,60	1.241,80	1.738,70
	720	300	598	BN5402B2.	1.108,30	1.303,90	1.825,60
	720	400	798	BN5402C2.	1.214,00	1.428,20	1.999,50
	920	250	498	BN5403A2.	1.266,80	1.490,10	2.086,30
	920	300	598	BN5403B2.	1.329,90	1.564,60	2.190,80
	920	400	798	BN5403C2.	1.456,70	1.713,70	2.399,30
	1220	250	498	BN5404A2.	1.520,00	1.788,30	2.503,70
	1220	300	598	BN5404B2.	1.596,00	1.877,80	2.628,70
	1220	400	798	BN5404C2.	1.747,90	2.056,60	2.878,90
	1520	250	498	BN5405A2.	1.747,90	2.056,60	2.878,90
	1520	300	598	BN5405B2.	1.835,60	2.159,40	3.023,10
	1520	400	798	BN5405C2.	2.010,10	2.365,10	3.311,10
1820	250	498	BN5406A2.	2.010,10	2.365,10	3.311,10	
1820	300	598	BN5406B2.	2.110,70	2.483,20	3.476,40	
1820	400	798	BN5406C2.	2.311,80	2.719,80	3.807,60	
2120	250	498	BN5407A2.	2.110,70	2.483,20	3.476,40	
2120	300	598	BN5407B2.	2.216,40	2.607,60	3.650,50	
2120	400	798	BN5407A2.	2.427,30	2.855,80	3.998,10	

WOODEN PANELS

WOODEN END PANEL BAYS

The functions below are suited for hanging on wooden end panel bays. Painted and veneered products are FSC-certified.

Wooden sign for wooden end panel bay

H368 mm. Incl. fittings.	Width mm	Shelf depth mm	Item no.	Melamine EUR	Painted EUR	Veneer EUR
	498	250	BN541A.	227,10	267,30	374,00
	598	300	BN541B.	264,60	311,10	435,90
	798	400	BN541C.	317,50	373,40	522,90

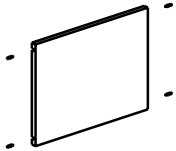

Steel display shelf for wooden end panel bay

H280 mm. Incl. fittings.	Width mm	Shelf depth mm	Item no.	Steel EUR
	498	250	BN542A	115,70
	598	300	BN542B	128,30
	798	400	BN542C	137,40

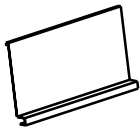

Wooden brochure rack for wooden end panel bay

H140 mm. Front and three adjustable dividers in acrylic glass. Incl. fittings.	Width mm	Shelf depth mm	Item no.	Melamine EUR	Painted EUR	Veneer EUR
	498	250	BN543A.	459,20	540,10	756,20
	598	300	BN543B.	534,00	628,20	879,30
	798	400	BN543C.	597,70	703,10	984,40

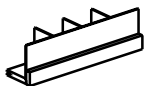

CONNECTION ELEMENTS

WOODEN BACK PANELS - FOR ADJUSTABLE FEET

Painted and veneered panels are FSC-certified.

WBP1 - high wooden back panel - for ST1 (standard depth)/ST2/ST3, WT1/WT3 (standard depth) and WO1

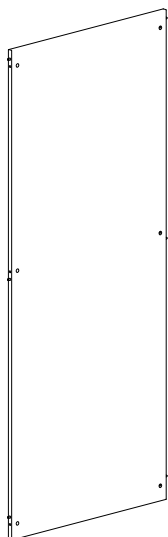

Height mm	Module mm	Item no.	Melamine EUR	Painted EUR	Veneer EUR
720	500	BN015254.	106,90	125,60	176,10
720	750	BN015274.	160,20	188,60	264,60
720	900	BN015294.	200,30	235,50	330,00
720	1000	BN015214.	213,60	251,50	351,90
920	500	BN015354.	136,60	160,80	225,50
920	750	BN015374.	205,00	241,10	337,70
920	900	BN015394.	256,20	301,50	422,10
920	1000	BN015314.	273,20	321,40	449,40
1220	500	BN015454.	182,30	214,70	300,70
1220	750	BN015474.	274,00	322,20	450,80
1220	900	BN015494.	330,40	388,70	544,60
1220	1000	BN015414.	364,60	428,90	600,10
1520	500	BN015554.	223,30	262,60	367,90
1520	750	BN015574.	334,90	394,10	551,60
1520	900	BN015594.	409,40	481,70	674,90
1520	1000	BN015514.	447,10	526,20	735,90
1820	500	BN015654.	259,10	304,80	426,20
1820	750	BN015674.	388,30	456,70	639,70
1820	900	BN015694.	482,40	567,80	794,30
1820	1000	BN015614.	517,60	608,90	852,50
2120	500	BN015754.	299,40	351,90	493,00
2120	750	BN015774.	448,60	528,00	738,60
2120	900	BN015794.	556,70	655,00	917,40
2120	1000	BN015714.	597,90	703,60	985,00

WBP2 - low wooden back panel - for ST1 (full depth & double-sided) and WT1/WT3 (full depth & double-sided)

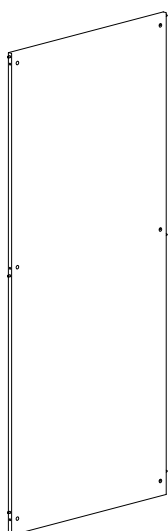

Height mm	Module mm	Item no.	Melamine EUR	Painted EUR	Veneer EUR
720	500	BN015256.	106,90	125,60	176,10
720	750	BN015276.	160,20	188,60	264,60
720	900	BN015296.	200,30	235,50	330,00
720	1000	BN015216.	213,60	251,50	351,90
920	500	BN015356.	136,60	160,80	225,50
920	750	BN015376.	205,00	241,10	337,70
920	900	BN015396.	256,20	301,50	422,10
920	1000	BN015316.	273,20	321,40	449,40
1220	500	BN015456.	182,30	214,70	300,70
1220	750	BN015476.	274,00	322,20	450,80
1220	900	BN015496.	330,40	388,70	544,60
1220	1000	BN015416.	364,60	428,90	600,10
1520	500	BN015556.	223,30	262,60	367,90
1520	750	BN015576.	334,90	394,10	551,60
1520	900	BN015596.	409,40	481,70	674,90
1520	1000	BN015516.	447,10	526,20	735,90
1820	500	BN015656.	259,10	304,80	426,20
1820	750	BN015676.	388,30	456,70	639,70
1820	900	BN015696.	482,40	567,80	794,30
1820	1000	BN015616.	517,60	608,90	852,50
2120	500	BN015756.	299,40	351,90	493,00
2120	750	BN015776.	448,60	528,00	738,60
2120	900	BN015796.	556,70	655,00	917,40
2120	1000	BN015716.	597,90	703,60	985,00

CONNECTION ELEMENTS

WOODEN BACK PANELS - FOR CASTOR PLATE

Painted and veneered panels are FSC-certified.

WBP3 - high wooden back panel - for ST1 (standard depth)/ST2/ST3, WT1/WT3 (standard depth) and WO1

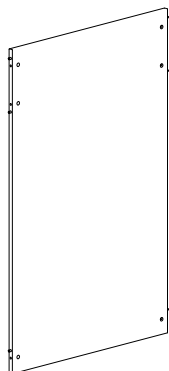

Height mm	Module mm	Item no.	Melamine EUR	Painted EUR	Veneer EUR
720	500	BN016254.	106,90	125,60	176,10
720	750	BN016274.	160,20	188,60	264,60
720	900	BN016294.	200,30	235,50	330,00
720	1000	BN016214.	213,60	251,50	351,90
920	500	BN016354.	136,60	160,80	225,50
920	750	BN016374.	205,00	241,10	337,70
920	900	BN016394.	256,20	301,50	422,10
920	1000	BN016314.	273,20	321,40	449,40
1220	500	BN016454.	182,30	214,70	300,70
1220	750	BN016474.	274,00	322,20	450,80
1220	900	BN016494.	330,40	388,70	544,60
1220	1000	BN016414.	364,60	428,90	600,10
1520	500	BN016554.	223,30	262,60	367,90
1520	750	BN016574.	334,90	394,10	551,60
1520	900	BN016594.	409,40	481,70	674,90
1520	1000	BN016514.	447,10	526,20	735,90

WBP4 - low wooden back panel - for ST1 (full depth & double-sided) and WT1/WT3 (full depth & double-sided)

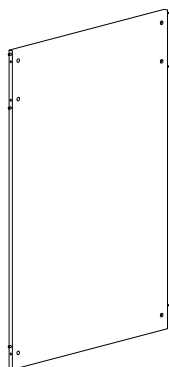

Height mm	Module mm	Item no.	Melamine EUR	Painted EUR	Veneer EUR
720	500	BN016256.	106,90	125,60	176,10
720	750	BN016276.	160,20	188,60	264,60
720	900	BN016296.	200,30	235,50	330,00
720	1000	BN016216.	213,60	251,50	351,90
920	500	BN016356.	136,60	160,80	225,50
920	750	BN016376.	205,00	241,10	337,70
920	900	BN016396.	256,20	301,50	422,10
920	1000	BN016316.	273,20	321,40	449,40
1220	500	BN016456.	182,30	214,70	300,70
1220	750	BN016476.	274,00	322,20	450,80
1220	900	BN016496.	330,40	388,70	544,60
1220	1000	BN016416.	364,60	428,90	600,10
1520	500	BN016556.	223,30	262,60	367,90
1520	750	BN016576.	334,90	394,10	551,60
1520	900	BN016596.	409,40	481,70	674,90
1520	1000	BN016516.	447,10	526,20	735,90

CONNECTION ELEMENTS

STEEL BACK FRAME

To ensure correct stability, double-sided shelvings H1820 mm and H2120 mm with back frame must have an additional steel back frames installed depending on number of bays. Configurations for freestanding bays include one additional back frame. Back frame for intermediate bays must be ordered separately, see overview page 11.

Steel back frame

Use for heights:
720/920/1220/1820/2120
mm. With fittings.

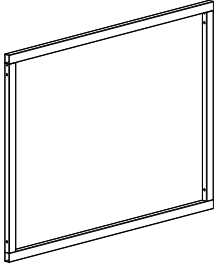

Module mm	Bay	Item no.	Price EUR
500	Freestanding	BN01054ZZZ8	78,30
750	Freestanding	BN01074ZZZ8	78,30
900	Freestanding	BN01094ZZZ8	78,30
1000	Freestanding	BN01014ZZZ8	88,80
500	Intermediate	BN01054ZZZ9	78,30
750	Intermediate	BN01074ZZZ9	78,30
900	Intermediate	BN01094ZZZ9	78,30
1000	Intermediate	BN01014ZZZ9	88,80

Additional steel back frame

Use for correct stability when
constructing more than one bay.
See guide on page 11.
With fittings.

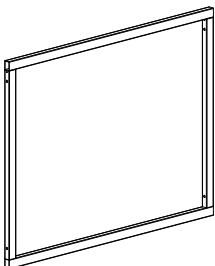

Module mm	Bay	Item no.	Price EUR
500	Freestanding	BN01254ZZZ3	78,30
750	Freestanding	BN01274ZZZ3	78,30
900	Freestanding	BN01294ZZZ3	78,30
1000	Freestanding	BN01214ZZZ3	88,80
500	Intermediate	BN01254ZZZ2	78,30
750	Intermediate	BN01274ZZZ2	78,30
900	Intermediate	BN01294ZZZ2	78,30
1000	Intermediate	BN01214ZZZ2	88,80
500	Outer	BN01254ZZZ1	78,30
750	Outer	BN01274ZZZ1	78,30
900	Outer	BN01294ZZZ1	78,30
1000	Outer	BN01214ZZZ1	88,80

CONNECTION ELEMENTS

CROSS BRACES

Galvanized cross braces - low

Use for heights: 720/920/1220 mm.	Module mm	Item no.	Price EUR
	500	BN02154	21,80
	750	BN02174	21,80
	900	BN02194	21,80
	1000	BN02114	21,80

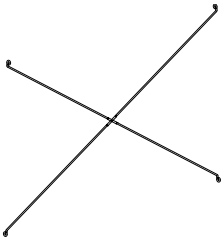

Galvanized cross braces - high

Use for heights: 1520/1820/2120 mm Middle shelf must be screwed on to the end panel when cross brace are used.	Module mm	Item no.	Price EUR
	500	BN02156	21,80
	750	BN02176	21,80
	900	BN02196	21,80
	1000	BN02116	21,80

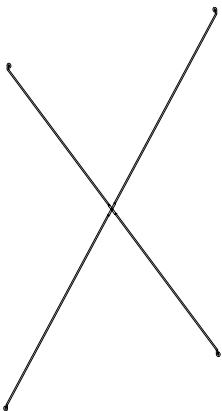



The Book LED lighting armature can be fitted on wooden top shelves and can be mounted over 1, 2 and 3 bays by use of connect fittings. Continuous runs require connect fitting.

The armature is CE-approved and available in white and steel as standard. For other colours, please ask customer service.

Armature

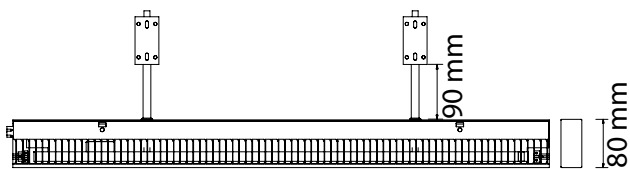

Model showing 2 bearing arms incl. light tube and louvre. Armature housing in aluminium.

Standard bearing arms

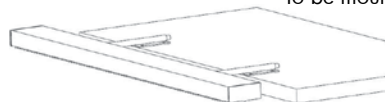

To be mounted on top of top shelf.

Front edge bearing arms





To be mounted on frontedge of predrilled top shelf/top plate (special request)

LIGHTING

BOOK LED LIGHTING

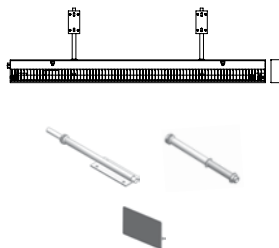
Below you will find a list of products needed when ordering lighting for 1, 2 or 3 bays. For 4 or more bays, you must use a combination of the armatures for 1, 2 or 3 bays by connecting the armatures with a connect fitting. Eg. for 10 bays, you can either use 5 x 2 bays (with 4 connect fittings) or 3 x 3 bays and 1 x 1 bay (with 3 connect fittings).

1 bay		Item no.	Price EUR
	Armature, module 50	B3900170527	1.280,30
	Armature, module 75	B3900170777	1.280,30
	Armature, module 90	B3900170927	1.280,30
	Armature, module 100	B3900171032	1.470,50
	Bearing arms, 2 pcs., standard	B39001512	269,00
	Bearing arms, 2 pcs., front edge	B39001522	269,00
End covers, 2 pcs.	B390011	164,20	
2 bays		Item no.	Price EUR
	Armature, module 50 + 50	B3900171054	1.799,80
	Armature, module 75 + 75	B3900171554	1.799,80
	Armature, module 90 + 90	B3900171854	2.015,90
	Armature, module 100 + 100	B3900172064	2.180,30
	Bearing arms, 2 pcs., standard or	B39001512	269,00
	Bearing arms, 2 pcs., front edge	B39001522	269,00
End covers, 2 pcs.	B390011	164,20	
3 bays		Item no.	Price EUR
	Armature, module 50 + 50 + 50	B3900171580	1.788,00
	Armature, module 75 + 75 + 75	B3900172330	2.681,70
	Armature, module 90 + 90 + 90	B3900172780	3.023,60
	Armature, module 100 + 100 + 100	B3900173095	3.270,90
	Bearing arms, 3 pcs., standard or	B39001513	376,30
	Bearing arms, 3 pcs., front edge	B39001523	376,30
End covers, 2 pcs.	B390011	164,20	
Cable 3 x 1.5 mm ² , L2500 mm		Item no.	Price EUR
		B390013	121,80
Connect fitting		Item no.	Price EUR
		B390012	35,10

LINGO ROUND SHELVING SYSTEM

BBN201 - 26° - STEEL BACK FRAME - ADJUSTABLE FEET - FOR TOP SHELF



LINGO ROUND SHELVING SYSTEM

BBN201 - 26° - STEEL BACK FRAME - ADJUSTABLE FEET - FOR TOP SHELF

Round shelving system with wooden panels and steel back frame. To be used with top shelf.
Freestanding bay includes 2 end wooden panels and 1 or 2 steel back frame depending on height.
Intermediate bay includes 1 intermediate wooden panel and 1 steel back frame.

- Prices based on steel price group 1 and wooden price group A (see Design Options pages 6-9).
- For top shelves, see from page 340
- For shelves, see from page 328

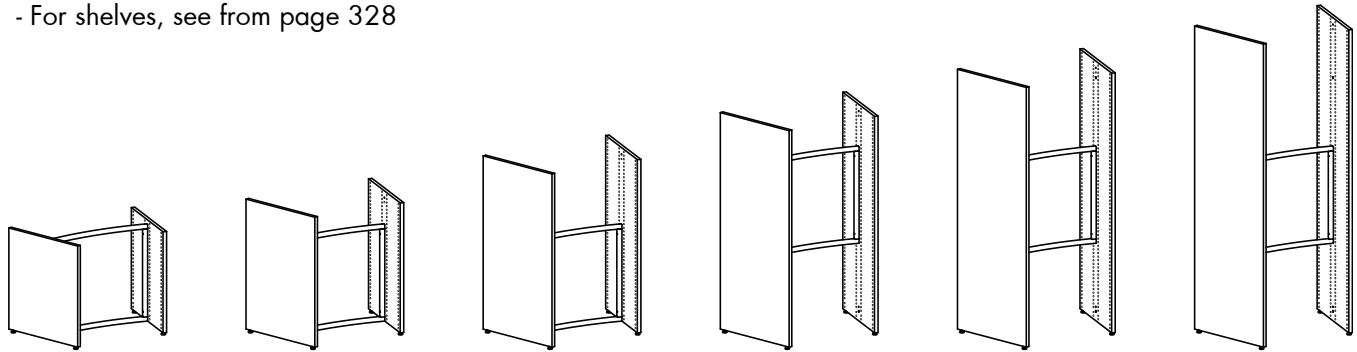

Double-sided freestanding bay - H720/920/1220/1520/1820/2120 mm

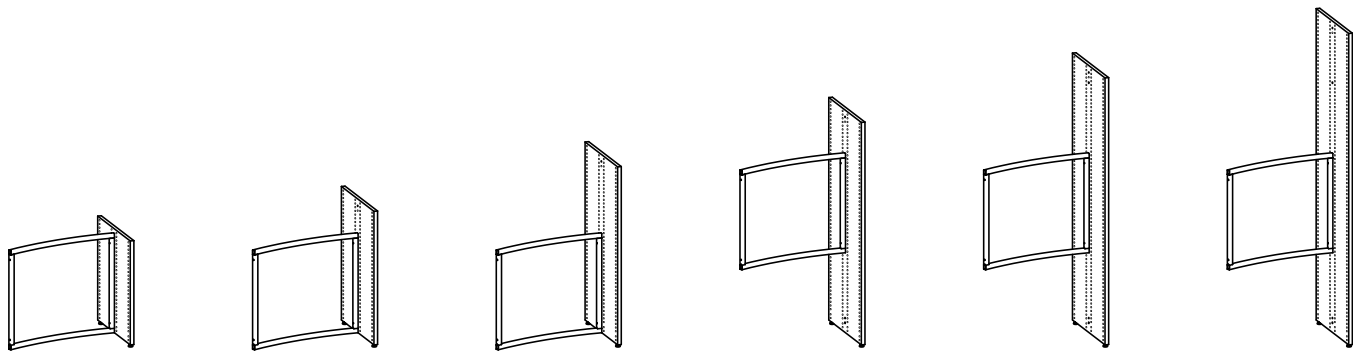

Double-sided intermediate bay - H720/920/1220/1520/1820/2120 mm

LINGO ROUND SHELVING SYSTEM

26° - STEEL BACK FRAME - ADJUSTABLE FEET - FOR TOP SHELF

Painted and veneered Lingo Shelving Systems are FSC-certified.

H720 mm

No. of bays	Item no. Freestanding bay	Melamine EUR	Painted EUR	Veneer EUR	Item no. Intermediate bay	Melamine EUR	Painted EUR	Veneer EUR
1	BBN2011260100060.	756,40	842,40	1.109,80	BBN2014260100060.	511,80	554,80	670,10
2	BBN2011260200060.	1.268,20	1.397,20	1.779,90	BBN2014260200060.	1.023,60	1.109,60	1.340,20
3	BBN2011260300060.	1.780,00	1.952,00	2.450,00	BBN2014260300060.	1.535,40	1.664,40	2.010,30
4	BBN2011260400060.	2.291,80	2.506,80	3.120,10	BBN2014260400060.	2.047,20	2.219,20	2.680,40
5	BBN2011260500060.	2.803,60	3.061,60	3.790,20	BBN2014260500060.	2.559,00	2.774,00	3.350,50
6	BBN2011260600060.	3.315,40	3.616,40	4.460,30	BBN2014260600060.	3.070,80	3.328,80	4.020,60
7	BBN2011260700060.	3.827,20	4.171,20	5.130,40	BBN2014260700060.	3.582,60	3.883,60	4.690,70
8	BBN2011260800060.	4.339,00	4.726,00	5.800,50				
9	BBN2011260900060.	4.850,80	5.280,80	6.470,60				
10	BBN2011261000060.	5.362,60	5.835,60	7.140,70				
11	BBN2011261100060.	5.874,40	6.390,40	7.810,80				
12	BBN2011261200060.	6.386,20	6.945,20	8.480,90				

H920 mm

No. of bays	Item no. Freestanding bay	Melamine EUR	Painted EUR	Veneer EUR	Item no. Intermediate bay	Melamine EUR	Painted EUR	Veneer EUR
1	BBN2011360100060.	892,40	1.003,00	1.297,40	BBN2014360100060.	579,80	635,10	782,30
2	BBN2011360200060.	1.472,20	1.638,10	2.079,70	BBN2014360200060.	1.159,60	1.270,20	1.564,60
3	BBN2011360300060.	2.052,00	2.273,20	2.862,00	BBN2014360300060.	1.739,40	1.905,30	2.346,90
4	BBN2011360400060.	2.631,80	2.908,30	3.644,30	BBN2014360400060.	2.319,20	2.540,40	3.129,20
5	BBN2011360500060.	3.211,60	3.543,40	4.426,60	BBN2014360500060.	2.899,00	3.175,50	3.911,50
6	BBN2011360600060.	3.791,40	4.178,50	5.208,90	BBN2014360600060.	3.478,80	3.810,60	4.693,80
7	BBN2011360700060.	4.371,20	4.813,60	5.991,20	BBN2014360700060.	4.058,60	4.445,70	5.476,10
8	BBN2011360800060.	4.951,00	5.448,70	6.773,50				
9	BBN2011360900060.	5.530,80	6.083,80	7.555,80				
10	BBN2011361000060.	6.110,60	6.718,90	8.338,10				
11	BBN2011361100060.	6.690,40	7.354,00	9.120,40				
12	BBN2011361200060.	7.270,20	7.989,10	9.902,70				

H1220 mm

No. of bays	Item no. Freestanding bay	Melamine EUR	Painted EUR	Veneer EUR	Item no. Intermediate bay	Melamine EUR	Painted EUR	Veneer EUR
1	BBN2011460100060.	1.079,60	1.222,80	1.606,00	BBN2014460100060.	673,40	745,00	936,60
2	BBN2011460200060.	1.753,00	1.967,80	2.542,60	BBN2014460200060.	1.346,80	1.490,00	1.873,20
3	BBN2011460300060.	2.426,40	2.712,80	3.479,20	BBN2014460300060.	2.020,20	2.235,00	2.809,80
4	BBN2011460400060.	3.099,80	3.457,80	4.415,80	BBN2014460400060.	2.693,60	2.980,00	3.746,40
5	BBN2011460500060.	3.773,20	4.202,80	5.352,40	BBN2014460500060.	3.367,00	3.725,00	4.683,00
6	BBN2011460600060.	4.446,60	4.947,80	6.289,00	BBN2014460600060.	4.040,40	4.470,00	5.619,60
7	BBN2011460700060.	5.120,00	5.692,80	7.225,60	BBN2014460700060.	4.713,80	5.215,00	6.556,20
8	BBN2011460800060.	5.793,40	6.437,80	8.162,20				
9	BBN2011460900060.	6.466,80	7.182,80	9.098,80				
10	BBN2011461000060.	7.140,20	7.927,80	10.035,40				
11	BBN2011461100060.	7.813,60	8.672,80	10.972,00				
12	BBN2011461200060.	8.487,00	9.417,80	11.908,60				

LINGO ROUND SHELVING SYSTEM

26° - STEEL BACK FRAME - ADJUSTABLE FEET - FOR TOP SHELF

Painted and veneered Lingo Shelving Systems are FSC-certified.

H1520 mm

No. of bays	Item no. Freestanding bay	Melamine EUR	Painted EUR	Veneer EUR	Item no. Intermediate bay	Melamine EUR	Painted EUR	Veneer EUR
1	BBN2011560100060.	1.123,00	1.274,00	1.677,60	BBN2014560100060.	695,10	770,60	972,40
2	BBN2011560200060.	1.818,10	2.044,60	2.650,00	BBN2014560200060.	1.390,20	1.541,20	1.944,80
3	BBN2011560300060.	2.513,20	2.815,20	3.622,40	BBN2014560300060.	2.085,30	2.311,80	2.917,20
4	BBN2011560400060.	3.208,30	3.585,80	4.594,80	BBN2014560400060.	2.780,40	3.082,40	3.889,60
5	BBN2011560500060.	3.903,40	4.356,40	5.567,20	BBN2014560500060.	3.475,50	3.853,00	4.862,00
6	BBN2011560600060.	4.598,50	5.127,00	6.539,60	BBN2014560600060.	4.170,60	4.623,60	5.834,40
7	BBN2011560700060.	5.293,60	5.897,60	7.512,00	BBN2014560700060.	4.865,70	5.394,20	6.806,80
8	BBN2011560800060.	5.988,70	6.668,20	8.484,40				
9	BBN2011560900060.	6.683,80	7.438,80	9.456,80				
10	BBN2011561000060.	7.378,90	8.209,40	10.429,20				
11	BBN2011561100060.	8.074,00	8.980,00	11.401,60				
12	BBN2011561200060.	8.769,10	9.750,60	12.374,00				

H1820 mm

No. of bays	Item no. Freestanding bay	Melamine EUR	Painted EUR	Veneer EUR	Item no. Intermediate bay	Melamine EUR	Painted EUR	Veneer EUR
1	BBN2011660100060.	1.278,20	1.457,20	1.932,80	BBN2014660100060.	772,70	862,20	1.100,00
2	BBN2011660200060.	2.050,90	2.319,40	3.032,80	BBN2014660200060.	1.545,40	1.724,40	2.200,00
3	BBN2011660300060.	2.823,60	3.181,60	4.132,80	BBN2014660300060.	2.318,10	2.586,60	3.300,00
4	BBN2011660400060.	3.596,30	4.043,80	5.232,80	BBN2014660400060.	3.090,80	3.448,80	4.400,00
5	BBN2011660500060.	4.369,00	4.906,00	6.332,80	BBN2014660500060.	3.863,50	4.311,00	5.500,00
6	BBN2011660600060.	5.141,70	5.768,20	7.432,80	BBN2014660600060.	4.636,20	5.173,20	6.600,00
7	BBN2011660700060.	5.914,40	6.630,40	8.532,80	BBN2014660700060.	5.408,90	6.035,40	7.700,00
8	BBN2011660800060.	6.687,10	7.492,60	9.632,80				
9	BBN2011660900060.	7.459,80	8.354,80	10.732,80				
10	BBN2011661000060.	8.232,50	9.217,00	11.832,80				
11	BBN2011661100060.	9.005,20	10.079,20	12.932,80				
12	BBN2011661200060.	9.777,90	10.941,40	14.032,80				

H2120 mm

No. of bays	Item no. Freestanding bay	Melamine EUR	Painted EUR	Veneer EUR	Item no. Intermediate bay	Melamine EUR	Painted EUR	Veneer EUR
1	BBN2011760100060.	1.428,20	1.633,40	2.179,80	BBN2014760100060.	847,70	950,30	1.223,50
2	BBN2011760200060.	2.275,90	2.583,70	3.403,30	BBN2014760200060.	1.695,40	1.900,60	2.447,00
3	BBN2011760300060.	3.123,60	3.534,00	4.626,80	BBN2014760300060.	2.543,10	2.850,90	3.670,50
4	BBN2011760400060.	3.971,30	4.484,30	5.850,30	BBN2014760400060.	3.390,80	3.801,20	4.894,00
5	BBN2011760500060.	4.819,00	5.434,60	7.073,80	BBN2014760500060.	4.238,50	4.751,50	6.117,50
6	BBN2011760600060.	5.666,70	6.384,90	8.297,30	BBN2014760600060.	5.086,20	5.701,80	7.341,00
7	BBN2011760700060.	6.514,40	7.335,20	9.520,80	BBN2014760700060.	5.933,90	6.652,10	8.564,50
8	BBN2011760800060.	7.362,10	8.285,50	10.744,30				
9	BBN2011760900060.	8.209,80	9.235,80	11.967,80				
10	BBN2011761000060.	9.057,50	10.186,10	13.191,30				
11	BBN2011761100060.	9.905,20	11.136,40	14.414,80				
12	BBN2011761200060.	10.752,90	12.086,70	15.638,30				

LINGO ROUND SHELVING SYSTEM

BBN201 - 26° - HIGH STEEL BACK PANEL - ADJUSTABLE FEET - FOR TOP SHELF



LINGO ROUND SHELVING SYSTEM

BBN201 - 26° - HIGH STEEL BACK PANEL - ADJUSTABLE FEET - FOR TOP SHELF

Round shelving system with wooden panels and high steel back panel.

To be used with top shelf WT5 standard depth top shelf.

Freestanding bay includes 2 wooden end panels and 1 high steel back panel.

Intermediate bay includes 1 intermediate wooden panel and 1 high steel back panel.

- Prices based on steel price group 1 and wooden price group A (see Design Options pages 6-9).

- For top shelves, see from page 340

- For shelves, see from page 328

- For castor frame, see page 347

- For end panel bay, see page 358

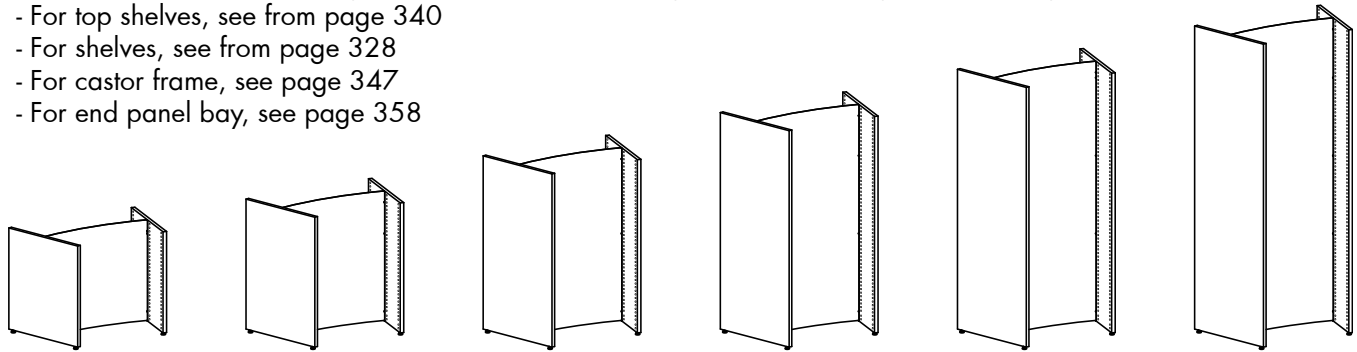

Double-sided freestanding bay - H720/920/1220/1520/1820/2120 mm

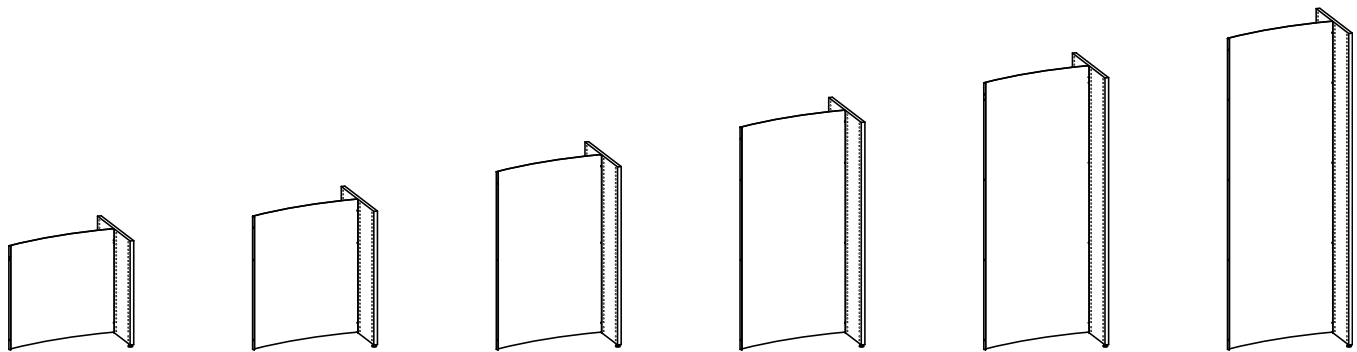

Double-sided intermediate bay - H720/920/1220/1520/1820/2120 mm

LINGO ROUND SHELVING SYSTEM

26° - HIGH STEEL BACK PANEL - ADJUSTABLE FEET - FOR TOP SHELF

Painted and veneered Lingo Shelving Systems are FSC-certified.

H720 mm

No. of bays	Item no. Freestanding bay	Melamine EUR	Painted EUR	Veneer EUR	Item no. Intermediate bay	Melamine EUR	Painted EUR	Veneer EUR
1	BBN2011260100070.	689,70	775,70	1.043,10	BBN2014260100070.	445,10	488,10	603,40
2	BBN2011260200070.	1.134,80	1.263,80	1.646,50	BBN2014260200070.	890,20	976,20	1.206,80
3	BBN2011260300070.	1.579,90	1.751,90	2.249,90	BBN2014260300070.	1.335,30	1.464,30	1.810,20
4	BBN2011260400070.	2.025,00	2.240,00	2.853,30	BBN2014260400070.	1.780,40	1.952,40	2.413,60
5	BBN2011260500070.	2.470,10	2.728,10	3.456,70	BBN2014260500070.	2.225,50	2.440,50	3.017,00
6	BBN2011260600070.	2.915,20	3.216,20	4.060,10	BBN2014260600070.	2.670,60	2.928,60	3.620,40
7	BBN2011260700070.	3.360,30	3.704,30	4.663,50	BBN2014260700070.	3.115,70	3.416,70	4.223,80
8	BBN2011260800070.	3.805,40	4.192,40	5.266,90				
9	BBN2011260900070.	4.250,50	4.680,50	5.870,30				
10	BBN2011261000070.	4.695,60	5.168,60	6.473,70				
11	BBN2011261100070.	5.140,70	5.656,70	7.077,10				
12	BBN2011261200070.	5.585,80	6.144,80	7.680,50				

H920 mm

No. of bays	Item no. Freestanding bay	Melamine EUR	Painted EUR	Veneer EUR	Item no. Intermediate bay	Melamine EUR	Painted EUR	Veneer EUR
1	BBN2011360100070.	881,30	991,90	1.286,30	BBN2014360100070.	568,70	624,00	771,20
2	BBN2011360200070.	1.450,00	1.615,90	2.057,50	BBN2014360200070.	1.137,40	1.248,00	1.542,40
3	BBN2011360300070.	2.018,70	2.239,90	2.828,70	BBN2014360300070.	1.706,10	1.872,00	2.313,60
4	BBN2011360400070.	2.587,40	2.863,90	3.599,90	BBN2014360400070.	2.274,80	2.496,00	3.084,80
5	BBN2011360500070.	3.156,10	3.487,90	4.371,10	BBN2014360500070.	2.843,50	3.120,00	3.856,00
6	BBN2011360600070.	3.724,80	4.111,90	5.142,30	BBN2014360600070.	3.412,20	3.744,00	4.627,20
7	BBN2011360700070.	4.293,50	4.735,90	5.913,50	BBN2014360700070.	3.980,90	4.368,00	5.398,40
8	BBN2011360800070.	4.862,20	5.359,90	6.684,70				
9	BBN2011360900070.	5.430,90	5.983,90	7.455,90				
10	BBN2011361000070.	5.999,60	6.607,90	8.227,10				
11	BBN2011361100070.	6.568,30	7.231,90	8.998,30				
12	BBN2011361200070.	7.137,00	7.855,90	9.769,50				

H1220 mm

No. of bays	Item no. Freestanding bay	Melamine EUR	Painted EUR	Veneer EUR	Item no. Intermediate bay	Melamine EUR	Painted EUR	Veneer EUR
1	BBN2011460100070.	1.152,10	1.295,30	1.678,50	BBN2014460100070.	745,90	817,50	1.009,10
2	BBN2011460200070.	1.898,00	2.112,80	2.687,60	BBN2014460200070.	1.491,80	1.635,00	2.018,20
3	BBN2011460300070.	2.643,90	2.930,30	3.696,70	BBN2014460300070.	2.237,70	2.452,50	3.027,30
4	BBN2011460400070.	3.389,80	3.747,80	4.705,80	BBN2014460400070.	2.983,60	3.270,00	4.036,40
5	BBN2011460500070.	4.135,70	4.565,30	5.714,90	BBN2014460500070.	3.729,50	4.087,50	5.045,50
6	BBN2011460600070.	4.881,60	5.382,80	6.724,00	BBN2014460600070.	4.475,40	4.905,00	6.054,60
7	BBN2011460700070.	5.627,50	6.200,30	7.733,10	BBN2014460700070.	5.221,30	5.722,50	7.063,70
8	BBN2011460800070.	6.373,40	7.017,80	8.742,20				
9	BBN2011460900070.	7.119,30	7.835,30	9.751,30				
10	BBN2011461000070.	7.865,20	8.652,80	10.760,40				
11	BBN2011461100070.	8.611,10	9.470,30	11.769,50				
12	BBN2011461200070.	9.357,00	10.287,80	12.778,60				

LINGO ROUND SHELVING SYSTEM

26° - HIGH STEEL BACK PANEL - ADJUSTABLE FEET - FOR TOP SHELF

Painted and veneered Lingo Shelving Systems are FSC-certified.

H1520 mm

No. of bays	Item no. Freestanding bay	Melamine EUR	Painted EUR	Veneer EUR	Item no. Intermediate bay	Melamine EUR	Painted EUR	Veneer EUR
1	BBN2011560100070.	1.278,90	1.429,90	1.833,50	BBN2014560100070.	851,00	926,50	1.128,30
2	BBN2011560200070.	2.129,90	2.356,40	2.961,80	BBN2014560200070.	1.702,00	1.853,00	2.256,60
3	BBN2011560300070.	2.980,90	3.282,90	4.090,10	BBN2014560300070.	2.553,00	2.779,50	3.384,90
4	BBN2011560400070.	3.831,90	4.209,40	5.218,40	BBN2014560400070.	3.404,00	3.706,00	4.513,20
5	BBN2011560500070.	4.682,90	5.135,90	6.346,70	BBN2014560500070.	4.255,00	4.632,50	5.641,50
6	BBN2011560600070.	5.533,90	6.062,40	7.475,00	BBN2014560600070.	5.106,00	5.559,00	6.769,80
7	BBN2011560700070.	6.384,90	6.988,90	8.603,30	BBN2014560700070.	5.957,00	6.485,50	7.898,10
8	BBN2011560800070.	7.235,90	7.915,40	9.731,60				
9	BBN2011560900070.	8.086,90	8.841,90	10.859,90				
10	BBN2011561000070.	8.937,90	9.768,40	11.988,20				
11	BBN2011561100070.	9.788,90	10.694,90	13.116,50				
12	BBN2011561200070.	10.639,90	11.621,40	14.244,80				

H1820 mm

No. of bays	Item no. Freestanding bay	Melamine EUR	Painted EUR	Veneer EUR	Item no. Intermediate bay	Melamine EUR	Painted EUR	Veneer EUR
1	BBN2011660100070.	1.517,60	1.696,60	2.172,20	BBN2014660100070.	1.012,10	1.101,60	1.339,40
2	BBN2011660200070.	2.529,70	2.798,20	3.511,60	BBN2014660200070.	2.024,20	2.203,20	2.678,80
3	BBN2011660300070.	3.541,80	3.899,80	4.851,00	BBN2014660300070.	3.036,30	3.304,80	4.018,20
4	BBN2011660400070.	4.553,90	5.001,40	6.190,40	BBN2014660400070.	4.048,40	4.406,40	5.357,60
5	BBN2011660500070.	5.566,00	6.103,00	7.529,80	BBN2014660500070.	5.060,50	5.508,00	6.697,00
6	BBN2011660600070.	6.578,10	7.204,60	8.869,20	BBN2014660600070.	6.072,60	6.609,60	8.036,40
7	BBN2011660700070.	7.590,20	8.306,20	10.208,60	BBN2014660700070.	7.084,70	7.711,20	9.375,80
8	BBN2011660800070.	8.602,30	9.407,80	11.548,00				
9	BBN2011660900070.	9.614,40	10.509,40	12.887,40				
10	BBN2011661000070.	10.626,50	11.611,00	14.226,80				
11	BBN2011661100070.	11.638,60	12.712,60	15.566,20				
12	BBN2011661200070.	12.650,70	13.814,20	16.905,60				

H2120 mm

No. of bays	Item no. Freestanding bay	Melamine EUR	Painted EUR	Veneer EUR	Item no. Intermediate bay	Melamine EUR	Painted EUR	Veneer EUR
1	BBN2011760100070.	1.751,00	1.956,20	2.502,60	BBN2014760100070.	1.170,50	1.273,10	1.546,30
2	BBN2011760200070.	2.921,50	3.229,30	4.048,90	BBN2014760200070.	2.341,00	2.546,20	3.092,60
3	BBN2011760300070.	4.092,00	4.502,40	5.595,20	BBN2014760300070.	3.511,50	3.819,30	4.638,90
4	BBN2011760400070.	5.262,50	5.775,50	7.141,50	BBN2014760400070.	4.682,00	5.092,40	6.185,20
5	BBN2011760500070.	6.433,00	7.048,60	8.687,80	BBN2014760500070.	5.852,50	6.365,50	7.731,50
6	BBN2011760600070.	7.603,50	8.321,70	10.234,10	BBN2014760600070.	7.023,00	7.638,60	9.277,80
7	BBN2011760700070.	8.774,00	9.594,80	11.780,40	BBN2014760700070.	8.193,50	8.911,70	10.824,10
8	BBN2011760800070.	9.944,50	10.867,90	13.326,70				
9	BBN2011760900070.	11.115,00	12.141,00	14.873,00				
10	BBN2011761000070.	12.285,50	13.414,10	16.419,30				
11	BBN2011761100070.	13.456,00	14.687,20	17.965,60				
12	BBN2011761200070.	14.626,50	15.960,30	19.511,90				

LINGO ROUND SHELVING SYSTEM

BBN201 - 26° - LOW STEEL BACK PANEL - ADJUSTABLE FEET - FOR TOP SHELF



LINGO ROUND SHELVING SYSTEM

BBN201 - 26° - LOW STEEL BACK PANEL - ADJUSTABLE FEET - FOR TOP SHELF

Round shelving system with wooden panels and low steel back panel.

To be used with top shelves WT5 full depth and WT5 double-sided top shelf.

Freestanding bay includes 2 end wooden panels and 1 low steel back panel.

Intermediate bay includes 1 intermediate wooden panel and 1 low steel back panel.

- Prices based on steel price group 1 and wooden price group A (see Design Options pages 6-9).

- For top shelves, see from page 340

- For shelves, see from page 328

- For plinths, see page 349

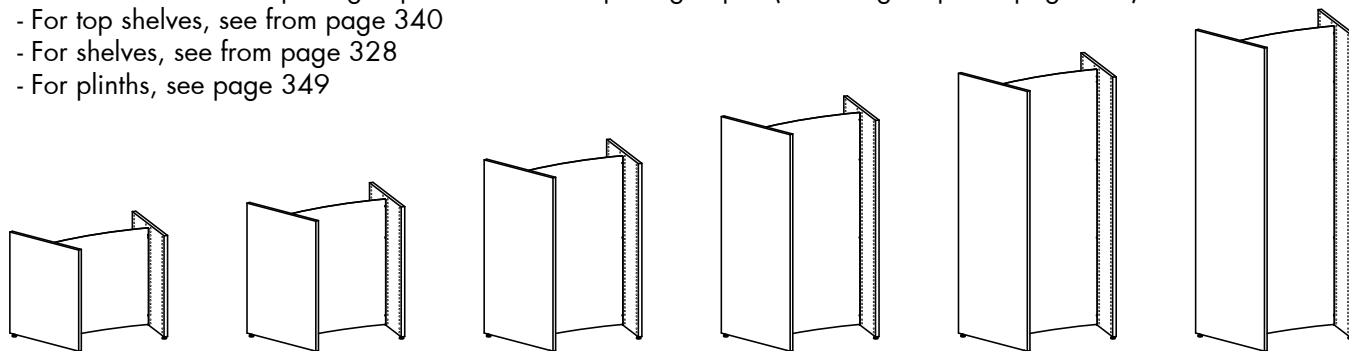

Double-sided freestanding bay - H720/920/1220/1520/1820/2120 mm

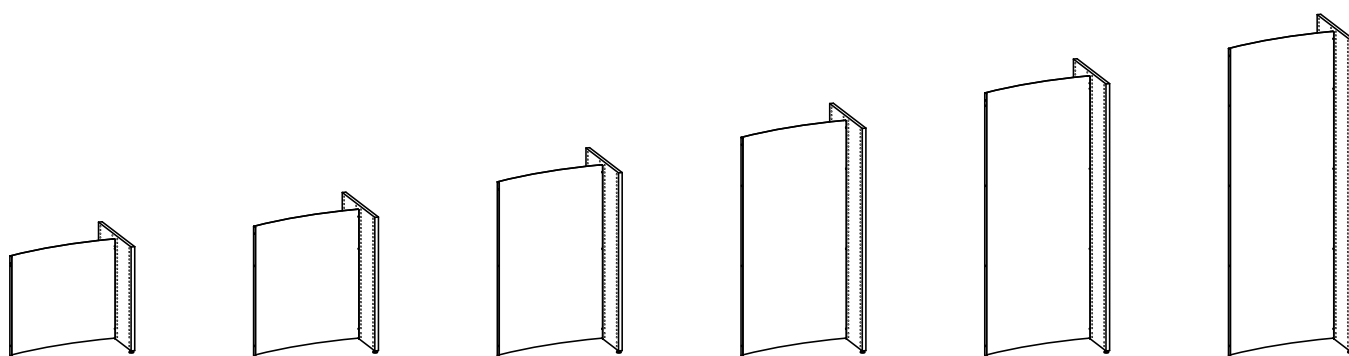

Double-sided intermediate bay - H720/920/1220/1520/1820/2120 mm

LINGO ROUND SHELVING SYSTEM

26° - LOW STEEL BACK PANEL - ADJUSTABLE FEET - FOR TOP SHELF

Painted and veneered Lingo Shelving Systems are FSC-certified.

H720 mm

No. of bays	Item no. Freestanding bay	Melamine EUR	Painted EUR	Veneer EUR	Item no. Intermediate bay	Melamine EUR	Painted EUR	Veneer EUR
1	BBN2011260100080.	689,70	775,70	1.043,10	BBN2014260100080.	445,10	488,10	603,40
2	BBN2011260200080.	1.134,80	1.263,80	1.646,50	BBN2014260200080.	890,20	976,20	1.206,80
3	BBN2011260300080.	1.579,90	1.751,90	2.249,90	BBN2014260300080.	1.335,30	1.464,30	1.810,20
4	BBN2011260400080.	2.025,00	2.240,00	2.853,30	BBN2014260400080.	1.780,40	1.952,40	2.413,60
5	BBN2011260500080.	2.470,10	2.728,10	3.456,70	BBN2014260500080.	2.225,50	2.440,50	3.017,00
6	BBN2011260600080.	2.915,20	3.216,20	4.060,10	BBN2014260600080.	2.670,60	2.928,60	3.620,40
7	BBN2011260700080.	3.360,30	3.704,30	4.663,50	BBN2014260700080.	3.115,70	3.416,70	4.223,80
8	BBN2011260800080.	3.805,40	4.192,40	5.266,90				
9	BBN2011260900080.	4.250,50	4.680,50	5.870,30				
10	BBN2011261000080.	4.695,60	5.168,60	6.473,70				
11	BBN2011261100080.	5.140,70	5.656,70	7.077,10				
12	BBN2011261200080.	5.585,80	6.144,80	7.680,50				

H920 mm

No. of bays	Item no. Freestanding bay	Melamine EUR	Painted EUR	Veneer EUR	Item no. Intermediate bay	Melamine EUR	Painted EUR	Veneer EUR
1	BBN2011360100080.	881,30	991,90	1.286,30	BBN2014360100080.	568,70	624,00	771,20
2	BBN2011360200080.	1.450,00	1.615,90	2.057,50	BBN2014360200080.	1.137,40	1.248,00	1.542,40
3	BBN2011360300080.	2.018,70	2.239,90	2.828,70	BBN2014360300080.	1.706,10	1.872,00	2.313,60
4	BBN2011360400080.	2.587,40	2.863,90	3.599,90	BBN2014360400080.	2.274,80	2.496,00	3.084,80
5	BBN2011360500080.	3.156,10	3.487,90	4.371,10	BBN2014360500080.	2.843,50	3.120,00	3.856,00
6	BBN2011360600080.	3.724,80	4.111,90	5.142,30	BBN2014360600080.	3.412,20	3.744,00	4.627,20
7	BBN2011360700080.	4.293,50	4.735,90	5.913,50	BBN2014360700080.	3.980,90	4.368,00	5.398,40
8	BBN2011360800080.	4.862,20	5.359,90	6.684,70				
9	BBN2011360900080.	5.430,90	5.983,90	7.455,90				
10	BBN2011361000080.	5.999,60	6.607,90	8.227,10				
11	BBN2011361100080.	6.568,30	7.231,90	8.998,30				
12	BBN2011361200080.	7.137,00	7.855,90	9.769,50				

H1220 mm

No. of bays	Item no. Freestanding bay	Melamine EUR	Painted EUR	Veneer EUR	Item no. Intermediate bay	Melamine EUR	Painted EUR	Veneer EUR
1	BBN2011460100080.	1.152,10	1.295,30	1.678,50	BBN2014460100080.	745,90	817,50	1.009,10
2	BBN2011460200080.	1.898,00	2.112,80	2.687,60	BBN2014460200080.	1.491,80	1.635,00	2.018,20
3	BBN2011460300080.	2.643,90	2.930,30	3.696,70	BBN2014460300080.	2.237,70	2.452,50	3.027,30
4	BBN2011460400080.	3.389,80	3.747,80	4.705,80	BBN2014460400080.	2.983,60	3.270,00	4.036,40
5	BBN2011460500080.	4.135,70	4.565,30	5.714,90	BBN2014460500080.	3.729,50	4.087,50	5.045,50
6	BBN2011460600080.	4.881,60	5.382,80	6.724,00	BBN2014460600080.	4.475,40	4.905,00	6.054,60
7	BBN2011460700080.	5.627,50	6.200,30	7.733,10	BBN2014460700080.	5.221,30	5.722,50	7.063,70
8	BBN2011460800080.	6.373,40	7.017,80	8.742,20				
9	BBN2011460900080.	7.119,30	7.835,30	9.751,30				
10	BBN2011461000080.	7.865,20	8.652,80	10.760,40				
11	BBN2011461100080.	8.611,10	9.470,30	11.769,50				
12	BBN2011461200080.	9.357,00	10.287,80	12.778,60				

LINGO ROUND SHELVING SYSTEM

26° - LOW STEEL BACK PANEL - ADJUSTABLE FEET - FOR TOP SHELF

Painted and veneered Lingo Shelving Systems are FSC-certified.

H1520 mm

No. of bays	Item no. Freestanding bay	Melamine EUR	Painted EUR	Veneer EUR	Item no. Intermediate bay	Melamine EUR	Painted EUR	Veneer EUR
1	BBN2011560100080.	1.278,90	1.429,90	1.833,50	BBN2014560100080.	851,00	926,50	1.128,30
2	BBN2011560200080.	2.129,90	2.356,40	2.961,80	BBN2014560200080.	1.702,00	1.853,00	2.256,60
3	BBN2011560300080.	2.980,90	3.282,90	4.090,10	BBN2014560300080.	2.553,00	2.779,50	3.384,90
4	BBN2011560400080.	3.831,90	4.209,40	5.218,40	BBN2014560400080.	3.404,00	3.706,00	4.513,20
5	BBN2011560500080.	4.682,90	5.135,90	6.346,70	BBN2014560500080.	4.255,00	4.632,50	5.641,50
6	BBN2011560600080.	5.533,90	6.062,40	7.475,00	BBN2014560600080.	5.106,00	5.559,00	6.769,80
7	BBN2011560700080.	6.384,90	6.988,90	8.603,30	BBN2014560700080.	5.957,00	6.485,50	7.898,10
8	BBN2011560800080.	7.235,90	7.915,40	9.731,60				
9	BBN2011560900080.	8.086,90	8.841,90	10.859,90				
10	BBN2011561000080.	8.937,90	9.768,40	11.988,20				
11	BBN2011561100080.	9.788,90	10.694,90	13.116,50				
12	BBN2011561200080.	10.639,90	11.621,40	14.244,80				

H1820 mm

No. of bays	Item no. Freestanding bay	Melamine EUR	Painted EUR	Veneer EUR	Item no. Intermediate bay	Melamine EUR	Painted EUR	Veneer EUR
1	BBN2011660100080.	1.517,60	1.696,60	2.172,20	BBN2014660100080.	1.012,10	1.101,60	1.339,40
2	BBN2011660200080.	2.529,70	2.798,20	3.511,60	BBN2014660200080.	2.024,20	2.203,20	2.678,80
3	BBN2011660300080.	3.541,80	3.899,80	4.851,00	BBN2014660300080.	3.036,30	3.304,80	4.018,20
4	BBN2011660400080.	4.553,90	5.001,40	6.190,40	BBN2014660400080.	4.048,40	4.406,40	5.357,60
5	BBN2011660500080.	5.566,00	6.103,00	7.529,80	BBN2014660500080.	5.060,50	5.508,00	6.697,00
6	BBN2011660600080.	6.578,10	7.204,60	8.869,20	BBN2014660600080.	6.072,60	6.609,60	8.036,40
7	BBN2011660700080.	7.590,20	8.306,20	10.208,60	BBN2014660700080.	7.084,70	7.711,20	9.375,80
8	BBN2011660800080.	8.602,30	9.407,80	11.548,00				
9	BBN2011660900080.	9.614,40	10.509,40	12.887,40				
10	BBN2011661000080.	10.626,50	11.611,00	14.226,80				
11	BBN2011661100080.	11.638,60	12.712,60	15.566,20				
12	BBN2011661200080.	12.650,70	13.814,20	16.905,60				

H2120 mm

No. of bays	Item no. Freestanding bay	Melamine EUR	Painted EUR	Veneer EUR	Item no. Intermediate bay	Melamine EUR	Painted EUR	Veneer EUR
1	BBN2011760100080.	1.751,00	1.956,20	2.502,60	BBN2014760100080.	1.170,50	1.273,10	1.546,30
2	BBN2011760200080.	2.921,50	3.229,30	4.048,90	BBN2014760200080.	2.341,00	2.546,20	3.092,60
3	BBN2011760300080.	4.092,00	4.502,40	5.595,20	BBN2014760300080.	3.511,50	3.819,30	4.638,90
4	BBN2011760400080.	5.262,50	5.775,50	7.141,50	BBN2014760400080.	4.682,00	5.092,40	6.185,20
5	BBN2011760500080.	6.433,00	7.048,60	8.687,80	BBN2014760500080.	5.852,50	6.365,50	7.731,50
6	BBN2011760600080.	7.603,50	8.321,70	10.234,10	BBN2014760600080.	7.023,00	7.638,60	9.277,80
7	BBN2011760700080.	8.774,00	9.594,80	11.780,40	BBN2014760700080.	8.193,50	8.911,70	10.824,10
8	BBN2011760800080.	9.944,50	10.867,90	13.326,70				
9	BBN2011760900080.	11.115,00	12.141,00	14.873,00				
10	BBN2011761000080.	12.285,50	13.414,10	16.419,30				
11	BBN2011761100080.	13.456,00	14.687,20	17.965,60				
12	BBN2011761200080.	14.626,50	15.960,30	19.511,90				

LINGO ROUND SHELVING SYSTEM

BBN202 - 26° - STEEL BACK FRAME - ADJUSTABLE FEET - WITH TOP PLATE



LINGO ROUND SHELVING SYSTEM

BBN202 - 26° - STEEL BACK FRAME - ADJUSTABLE FEET - WITH TOP PLATE

Round shelving system with wooden end panels, intermediate panels, steel back frame and overlaying top plate. See further description on starter, intermediate and end sections on pages 26-27.

- Prices based on steel price group 1 and wooden price group A (see Design Options pages 6-9).
- For shelves, see from page 328
- For end panel bays, see page 378
- For plinths, see page 349

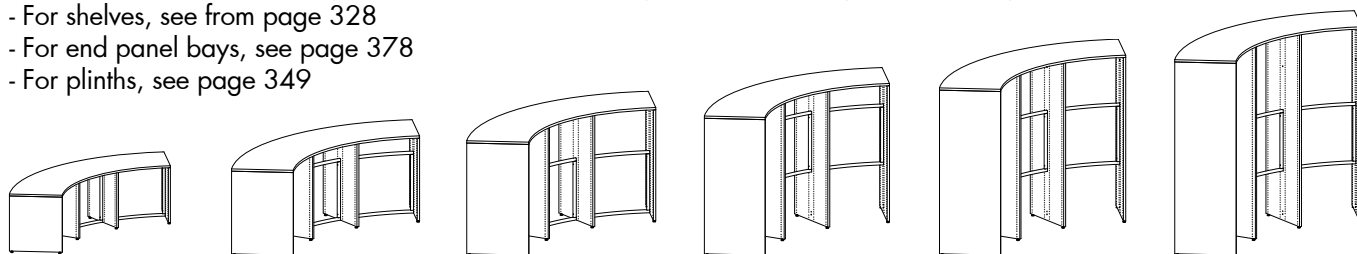

Freestanding 26° double-sided bays - H720/920/1220/1520/1820/2120 mm

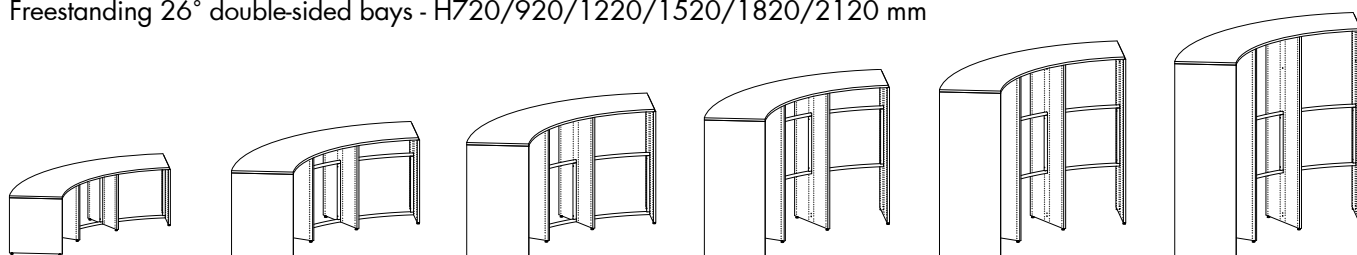

Left starter 26° double-sided bays - H720/920/1220/1520/1820/2120 mm

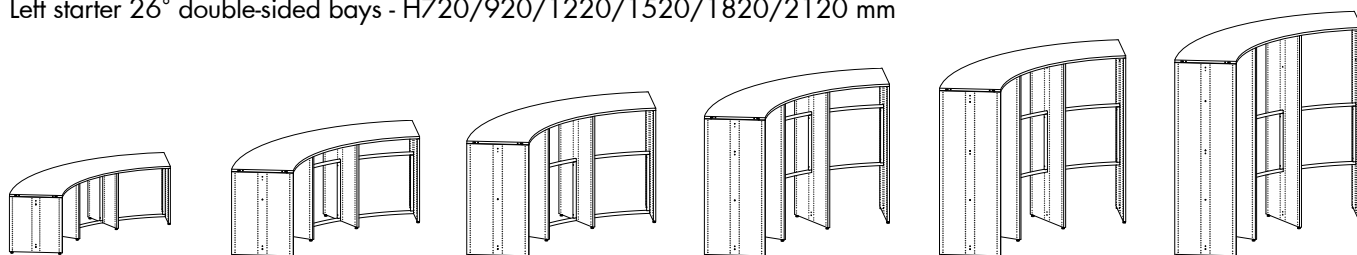

Right starter 26° double-sided bays - H720/920/1220/1520/1820/2120 mm

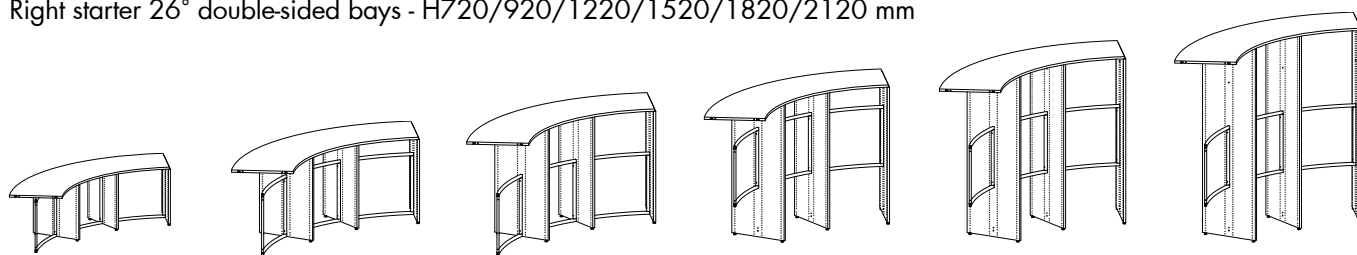

Intermediate 26° double-sided bays - H720/920/1220/1520/1820/2120 mm

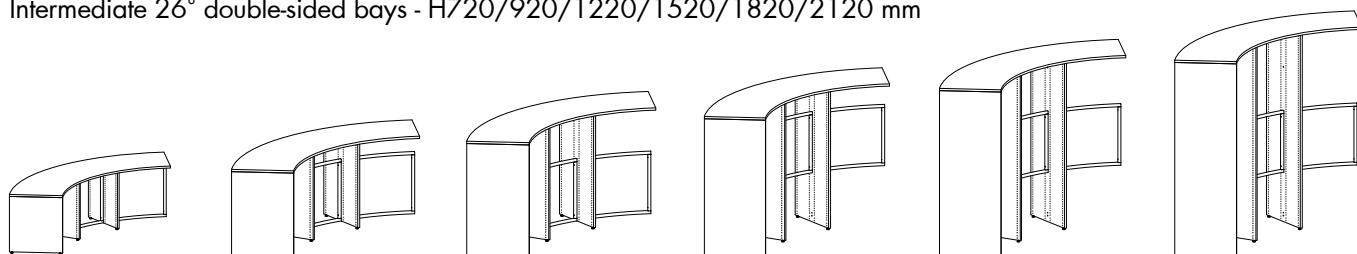

Left end 26° double-sided bays - H720/920/1220/1520/1820/2120 mm

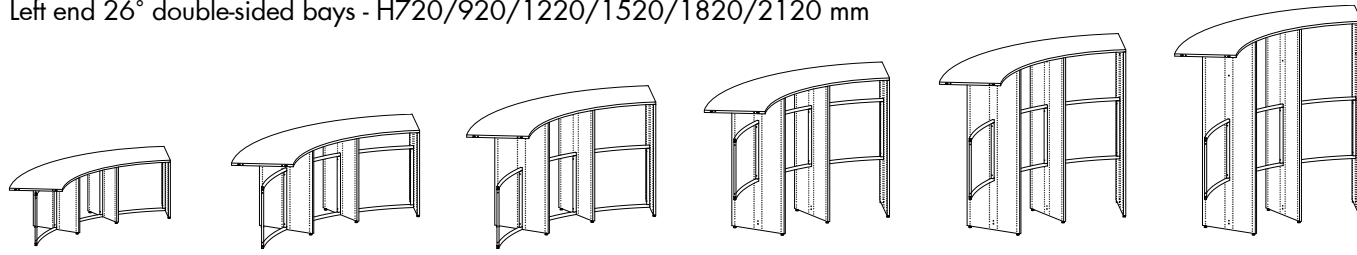

Right end 26° double-sided bays - H720/920/1220/1520/1820/2120 mm

LINGO ROUND SHELVING SYSTEM

26° - STEEL BACK FRAME - ADJUSTABLE FEET - WITH TOP PLATE - FREESTANDING SECTION

Painted and veneered Lingo Shelving Systems are FSC-certified.

H720 mm

No. of bays	Item no.	Melamine EUR	Painted EUR	Veneer EUR
1	BBN2021260110060.	1.530,20	1.752,60	2.347,60
2	BBN2021260210060.	3.003,00	3.438,00	4.600,30
3	BBN2021260310060.	5.437,90	6.255,10	8.437,50

H920 mm

No. of bays	Item no.	Melamine EUR	Painted EUR	Veneer EUR
1	BBN2021360110060.	1.666,20	1.913,20	2.572,00
2	BBN2021360210060.	3.207,00	3.678,90	4.936,90
3	BBN2021360310060.	5.709,90	6.576,30	8.886,30

H1220 mm

No. of bays	Item no.	Melamine EUR	Painted EUR	Veneer EUR
1	BBN2021460110060.	1.853,40	2.133,00	2.880,60
2	BBN2021460210060.	3.487,80	4.008,60	5.399,80
3	BBN2021460310060.	6.084,30	7.015,90	9.503,50

H1520 mm

No. of bays	Item no.	Melamine EUR	Painted EUR	Veneer EUR
1	BBN2021560110060.	1.896,80	2.184,20	2.952,20
2	BBN2021560210060.	3.552,90	4.085,40	5.507,20
3	BBN2021560310060.	6.171,10	7.118,30	9.646,70

H1820 mm

No. of bays	Item no.	Melamine EUR	Painted EUR	Veneer EUR
1	BBN2021660110060.	2.052,00	2.367,40	3.207,40
2	BBN2021660210060.	3.785,70	4.360,20	5.890,00
3	BBN2021660310060.	6.481,50	7.484,70	10.157,10

H2120 mm

No. of bays	Item no.	Melamine EUR	Painted EUR	Veneer EUR
1	BBN2021760110060.	2.202,00	2.543,60	3.454,40
2	BBN2021760210060.	4.010,70	4.624,50	6.260,50
3	BBN2021760310060.	6.781,50	7.837,10	10.651,10

LINGO ROUND SHELVING SYSTEM

26° - STEEL BACK FRAME - ADJUSTABLE FEET - WITH TOP PLATE - LEFT STARTER SECTION

Painted and veneered Lingo Shelving Systems are FSC-certified.

H720 mm

No. of bays	Item no.	Melamine EUR	Painted EUR	Veneer EUR
1	BBN2022260110060.	1.527,80	1.749,80	2.343,30
2	BBN2022260210060.	3.001,20	3.436,20	4.597,50
3	BBN2022260310060.	5.436,30	6.253,50	8.435,30

H920 mm

No. of bays	Item no.	Melamine EUR	Painted EUR	Veneer EUR
1	BBN2022360110060.	1.663,80	1.910,40	2.567,70
2	BBN2022360210060.	3.205,20	3.677,10	4.934,10
3	BBN2022360310060.	5.708,30	6.574,70	8.884,10

H1220 mm

No. of bays	Item no.	Melamine EUR	Painted EUR	Veneer EUR
1	BBN2022460110060.	1.851,00	2.130,20	2.876,30
2	BBN2022460210060.	3.486,00	4.006,80	5.397,00
3	BBN2022460310060.	6.082,70	7.014,30	9.501,30

H1520 mm

No. of bays	Item no.	Melamine EUR	Painted EUR	Veneer EUR
1	BBN2022560110060.	1.894,40	2.181,40	2.947,90
2	BBN2022560210060.	3.551,10	4.083,60	5.504,40
3	BBN2022560310060.	6.169,50	7.116,70	9.644,50

H1820 mm

No. of bays	Item no.	Melamine EUR	Painted EUR	Veneer EUR
1	BBN2022660110060.	2.049,60	2.364,60	3.203,10
2	BBN2022660210060.	3.783,90	4.358,40	5.887,20
3	BBN2022660310060.	6.479,90	7.483,10	10.154,90

H2120 mm

No. of bays	Item no.	Melamine EUR	Painted EUR	Veneer EUR
1	BBN2022760110060.	2.199,60	2.540,80	3.450,10
2	BBN2022760210060.	4.008,90	4.622,70	6.257,70
3	BBN2022760310060.	6.779,90	7.835,50	10.648,90

LINGO ROUND SHELVING SYSTEM

26° - STEEL BACK FRAME - ADJUSTABLE FEET - WITH TOP PLATE - RIGHT STARTER SECTION

Painted and veneered Lingo Shelving Systems are FSC-certified.

H720 mm

No. of bays	Item no.	Melamine EUR	Painted EUR	Veneer EUR
1	BBN2023260110060.	1.527,80	1.749,80	2.343,30
2	BBN2023260210060.	3.001,20	3.436,20	4.597,50
3	BBN2023260310060.	4.671,90	5.354,30	7.176,50

H920 mm

No. of bays	Item no.	Melamine EUR	Painted EUR	Veneer EUR
1	BBN2023360110060.	1.663,80	1.910,40	2.567,70
2	BBN2023360210060.	3.205,20	3.677,10	4.934,10
3	BBN2023360310060.	4.943,90	5.675,50	7.625,30

H1220 mm

No. of bays	Item no.	Melamine EUR	Painted EUR	Veneer EUR
1	BBN2023460110060.	1.851,00	2.130,20	2.876,30
2	BBN2023460210060.	3.486,00	4.006,80	5.397,00
3	BBN2023460310060.	5.318,30	6.115,10	8.242,50

H1520 mm

No. of bays	Item no.	Melamine EUR	Painted EUR	Veneer EUR
1	BBN2023560110060.	1.894,40	2.181,40	2.947,90
2	BBN2023560210060.	3.551,10	4.083,60	5.504,40
3	BBN2023560310060.	5.405,10	6.217,50	8.385,70

H1820 mm

No. of bays	Item no.	Melamine EUR	Painted EUR	Veneer EUR
1	BBN2023660110060.	2.049,60	2.364,60	3.203,10
2	BBN2023660210060.	3.783,90	4.358,40	5.887,20
3	BBN2023660310060.	5.715,50	6.583,90	8.896,10

H2120 mm

No. of bays	Item no.	Melamine EUR	Painted EUR	Veneer EUR
1	BBN2023760110060.	2.199,60	2.540,80	3.450,10
2	BBN2023760210060.	4.008,90	4.622,70	6.257,70
3	BBN2023760310060.	6.015,50	6.936,30	9.390,10

LINGO ROUND SHELVING SYSTEM

26° - STEEL BACK FRAME - ADJUSTABLE FEET - WITH TOP PLATE - INTERMEDIATE SECTION

Painted and veneered Lingo Shelving Systems are FSC-certified.

H720 mm

No. of bays	Item no.	Melamine EUR	Painted EUR	Veneer EUR
1	BBN2024260110060.	1.276,20	1.454,00	1.928,90
2	BBN2024260210060.	2.724,60	3.110,70	4.141,70
3	BBN2024260310060.	5.174,90	5.945,80	8.004,20

H920 mm

No. of bays	Item no.	Melamine EUR	Painted EUR	Veneer EUR
1	BBN2024360110060.	1.344,20	1.534,30	2.041,10
2	BBN2024360210060.	2.860,60	3.271,30	4.366,10
3	BBN2024360310060.	5.378,90	6.186,70	8.340,80

H1220 mm

No. of bays	Item no.	Melamine EUR	Painted EUR	Veneer EUR
1	BBN2024460110060.	1.437,80	1.644,20	2.195,40
2	BBN2024460210060.	3.047,80	3.491,10	4.674,70
3	BBN2024460310060.	5.659,70	6.516,40	8.803,70

H1520 mm

No. of bays	Item no.	Melamine EUR	Painted EUR	Veneer EUR
1	BBN2024560110060.	1.459,50	1.669,80	2.231,20
2	BBN2024560210060.	3.091,20	3.542,30	4.746,30
3	BBN2024560310060.	5.724,80	6.593,20	8.911,10

H1820 mm

No. of bays	Item no.	Melamine EUR	Painted EUR	Veneer EUR
1	BBN2024660110060.	1.537,10	1.761,40	2.358,80
2	BBN2024660210060.	3.246,40	3.725,50	5.001,50
3	BBN2024660310060.	5.957,60	6.868,00	9.293,90

H2120 mm

No. of bays	Item no.	Melamine EUR	Painted EUR	Veneer EUR
1	BBN2024760110060.	1.612,10	1.849,50	2.482,30
2	BBN2024760210060.	3.396,40	3.901,70	5.248,50
3	BBN2024760310060.	6.182,60	7.132,30	9.664,40

LINGO ROUND SHELVING SYSTEM

26° - STEEL BACK FRAME - ADJUSTABLE FEET - WITH TOP PLATE - LEFT END SECTION

Painted and veneered Lingo Shelving Systems are FSC-certified.

H720 mm

No. of bays	Item no.	Melamine EUR	Painted EUR	Veneer EUR
1	BBN2025260110060.	1.038,60	1.174,60	1.537,50
2	BBN2025260210060.	2.756,60	3.148,60	4.194,60
3	BBN2025260310060.	5.191,70	5.965,90	8.032,40

H920 mm

No. of bays	Item no.	Melamine EUR	Painted EUR	Veneer EUR
1	BBN2025360110060.	1.038,60	1.174,60	1.537,50
2	BBN2025360210060.	2.892,60	3.309,20	4.419,00
3	BBN2025360310060.	5.395,70	6.206,80	8.369,00

H1220 mm

No. of bays	Item no.	Melamine EUR	Painted EUR	Veneer EUR
1	BBN2025460110060.	1.038,60	1.174,60	1.537,50
2	BBN2025460210060.	3.079,80	3.529,00	4.727,60
3	BBN2025460310060.	5.676,50	6.536,50	8.831,90

H1520 mm

No. of bays	Item no.	Melamine EUR	Painted EUR	Veneer EUR
1	BBN2025560110060.	1.038,60	1.174,60	1.537,50
2	BBN2025560210060.	3.123,20	3.580,20	4.799,20
3	BBN2025560310060.	5.741,60	6.613,30	8.939,30

H1820 mm

No. of bays	Item no.	Melamine EUR	Painted EUR	Veneer EUR
1	BBN2025660110060.	1.038,60	1.174,60	1.537,50
2	BBN2025660210060.	3.278,40	3.763,40	5.054,40
3	BBN2025660310060.	5.974,40	6.888,10	9.322,10

H2120 mm

No. of bays	Item no.	Melamine EUR	Painted EUR	Veneer EUR
1	BBN2025760110060.	1.038,60	1.174,60	1.537,50
2	BBN2025760210060.	3.428,40	3.939,60	5.301,40
3	BBN2025760310060.	6.199,40	7.152,40	9.692,60

LINGO ROUND SHELVING SYSTEM

26° - STEEL BACK FRAME - ADJUSTABLE FEET - WITH TOP PLATE - RIGHT END SECTION

Painted and veneered Lingo Shelving Systems are FSC-certified.

H720 mm

No. of bays	Item no.	Melamine EUR	Painted EUR	Veneer EUR
1	BBN2026260110060.	1.038,60	1.174,60	1.537,50
2	BBN2026260210060.	2.756,60	3.148,60	4.194,60
3	BBN2026260310060.	4.427,30	5.066,70	6.773,60

H920 mm

No. of bays	Item no.	Melamine EUR	Painted EUR	Veneer EUR
1	BBN2026360110060.	1.038,60	1.174,60	1.537,50
2	BBN2026360210060.	2.892,60	3.309,20	4.419,00
3	BBN2026360310060.	4.631,30	5.307,60	7.110,20

H1220 mm

No. of bays	Item no.	Melamine EUR	Painted EUR	Veneer EUR
1	BBN2026460110060.	1.038,60	1.174,60	1.537,50
2	BBN2026460210060.	3.079,80	3.529,00	4.727,60
3	BBN2026460310060.	4.912,10	5.637,30	7.573,10

H1520 mm

No. of bays	Item no.	Melamine EUR	Painted EUR	Veneer EUR
1	BBN2026560110060.	1.038,60	1.174,60	1.537,50
2	BBN2026560210060.	3.123,20	3.580,20	4.799,20
3	BBN2026560310060.	4.977,20	5.714,10	7.680,50

H1820 mm

No. of bays	Item no.	Melamine EUR	Painted EUR	Veneer EUR
1	BBN2026660110060.	1.038,60	1.174,60	1.537,50
2	BBN2026660210060.	3.278,40	3.763,40	5.054,40
3	BBN2026660310060.	5.210,00	5.988,90	8.063,30

H2120 mm

No. of bays	Item no.	Melamine EUR	Painted EUR	Veneer EUR
1	BBN2026760110060.	1.038,60	1.174,60	1.537,50
2	BBN2026760210060.	3.428,40	3.939,60	5.301,40
3	BBN2026760310060.	5.435,00	6.253,20	8.433,80

LINGO ROUND SHELVING SYSTEM

BBN202 - 26° - STEEL BACK PANEL - ADJUSTABLE FEET - WITH TOP PLATE



LINGO ROUND SHELVING SYSTEM

BBN202 - 26° - STEEL BACK PANEL - ADJUSTABLE FEET - WITH TOP PLATE

Round shelving system with wooden end panels, intermediate panels, steel back panel and overlaying top plate.
See further description on starter, intermediate and end sections on pages 26-27.

- Prices based on steel price group 1 and wooden price group A (see Design Options pages 6-9).
- For shelves, see from page 328
- For castor frame, see page 347

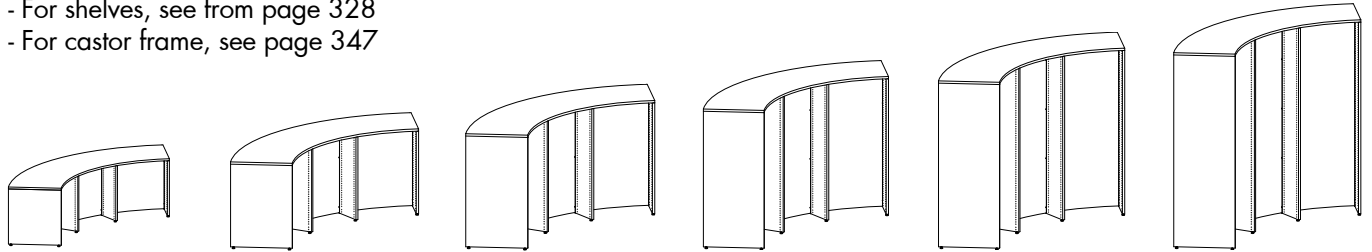

Freestanding 26° double-sided bays - H720/920/1220/1520/1820/2120 mm

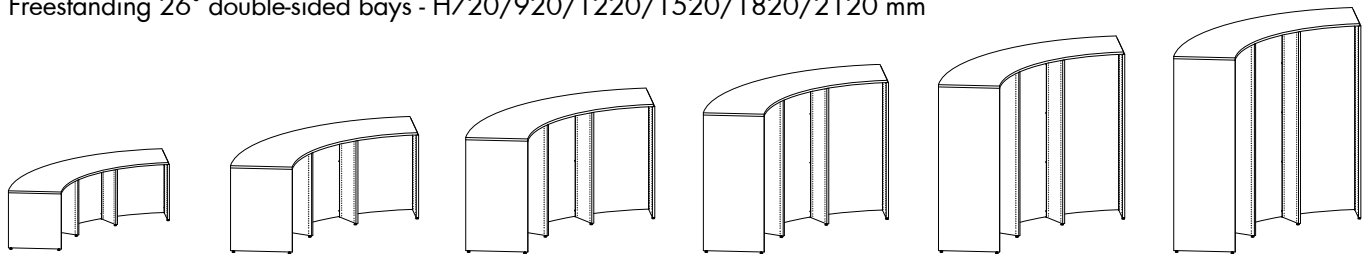

Left starter 26° double-sided bays - H720/920/1220/1520/1820/2120 mm

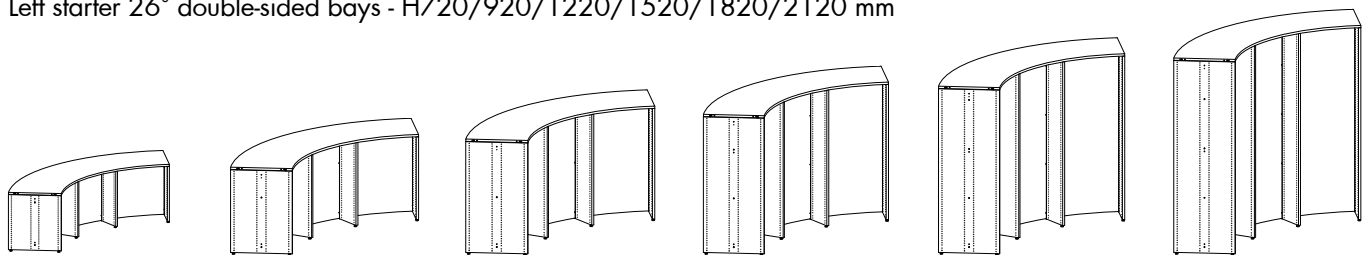

Right starter 26° double-sided bays - H720/920/1220/1520/1820/2120 mm

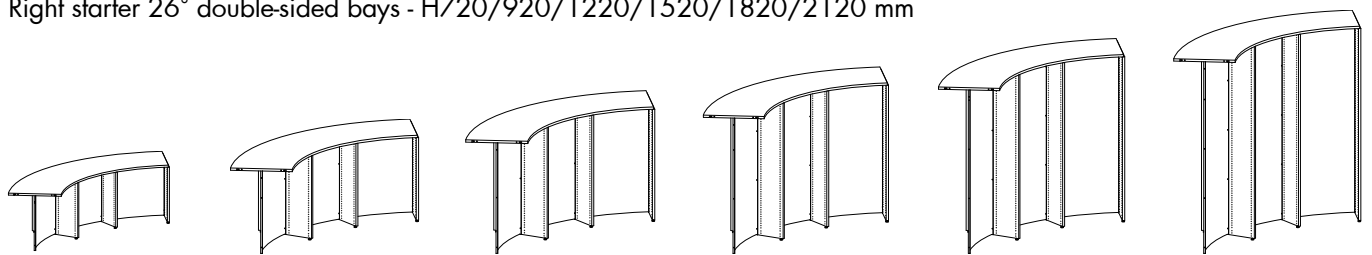

Intermediate 18° double-sided bays - H720/920/1220/1520/1820/2120 mm

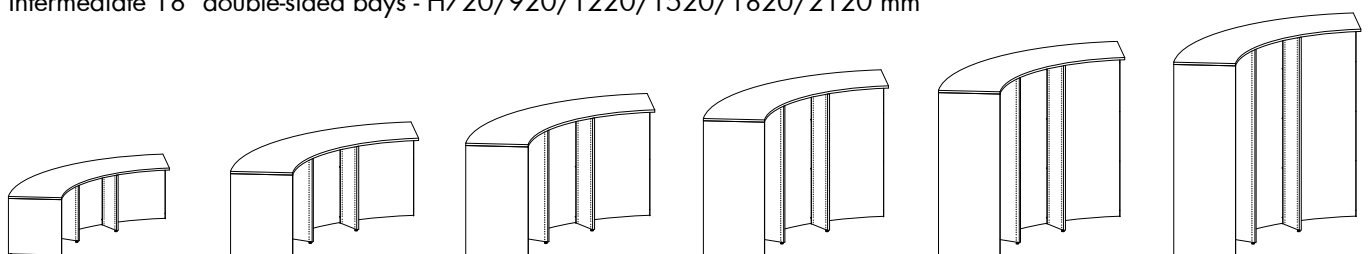

Left end 26° double-sided bays - H720/920/1220/1520/1820/2120 mm

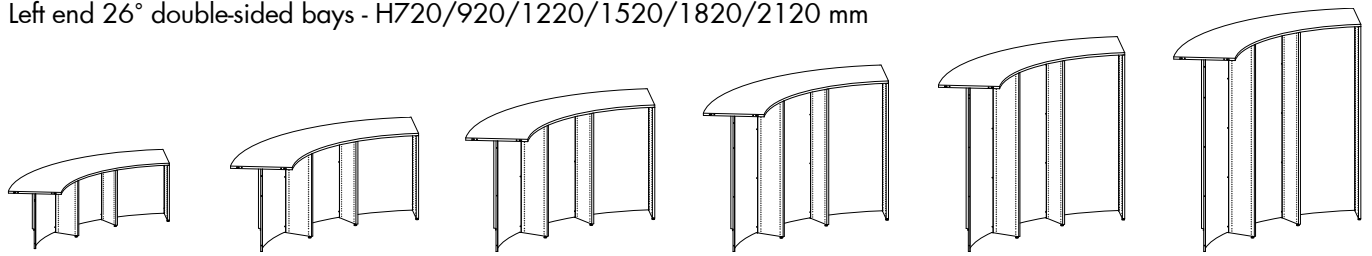

Right end 26° double-sided bays - H720/920/1220/1520/1820/2120 mm

LINGO ROUND SHELVING SYSTEM

26° - STEEL BACK PANEL - ADJUSTABLE FEET - WITH TOP PLATE - FREESTANDING SECTION

Painted and veneered Lingo Shelving Systems are FSC-certified.

H720 mm

No. of bays	Item no.	Melamine EUR	Painted EUR	Veneer EUR
1	BBN2021260110080.	1.463,50	1.685,90	2.280,90
2	BBN2021260210080.	2.869,60	3.304,60	4.466,90
3	BBN2021260310080.	5.237,80	6.055,00	8.237,40

H920 mm

No. of bays	Item no.	Melamine EUR	Painted EUR	Veneer EUR
1	BBN2021360110080.	1.655,10	1.902,10	2.560,90
2	BBN2021360210080.	3.184,80	3.656,70	4.914,70
3	BBN2021360310080.	5.676,60	6.543,00	8.853,00

H1220 mm

No. of bays	Item no.	Melamine EUR	Painted EUR	Veneer EUR
1	BBN2021460110080.	1.925,90	2.205,50	2.953,10
2	BBN2021460210080.	3.632,80	4.153,60	5.544,80
3	BBN2021460310080.	6.301,80	7.233,40	9.721,00

H1520 mm

No. of bays	Item no.	Melamine EUR	Painted EUR	Veneer EUR
1	BBN2021560110080.	2.052,70	2.340,10	3.108,10
2	BBN2021560210080.	3.864,70	4.397,20	5.819,00
3	BBN2021560310080.	6.638,80	7.586,00	10.114,40

H1820 mm

No. of bays	Item no.	Melamine EUR	Painted EUR	Veneer EUR
1	BBN2021660110080.	2.291,40	2.606,80	3.446,80
2	BBN2021660210080.	4.264,50	4.839,00	6.368,80
3	BBN2021660310080.	7.199,70	8.202,90	10.875,30

H2120 mm

No. of bays	Item no.	Melamine EUR	Painted EUR	Veneer EUR
1	BBN2021760110080.	2.524,80	2.866,40	3.777,20
2	BBN2021760210080.	4.656,30	5.270,10	6.906,10
3	BBN2021760310080.	7.749,90	8.805,50	11.619,50

LINGO ROUND SHELVING SYSTEM

26° - STEEL BACK PANEL - ADJUSTABLE FEET - WITH TOP PLATE - LEFT STARTER SECTION

Painted and veneered Lingo Shelving Systems are FSC-certified.

H720 mm

No. of bays	Item no.	Melamine EUR	Painted EUR	Veneer EUR
1	BBN2022260110080.	1.461,10	1.683,10	2.276,60
2	BBN2022260210080.	2.867,80	3.302,80	4.464,10
3	BBN2022260310080.	5.236,20	6.053,40	8.235,20

H920 mm

No. of bays	Item no.	Melamine EUR	Painted EUR	Veneer EUR
1	BBN2022360110080.	1.652,70	1.899,30	2.556,60
2	BBN2022360210080.	3.183,00	3.654,90	4.911,90
3	BBN2022360310080.	5.675,00	6.541,40	8.850,80

H1220 mm

No. of bays	Item no.	Melamine EUR	Painted EUR	Veneer EUR
1	BBN2022460110080.	1.923,50	2.202,70	2.948,80
2	BBN2022460210080.	3.631,00	4.151,80	5.542,00
3	BBN2022460310080.	6.300,20	7.231,80	9.718,80

H1520 mm

No. of bays	Item no.	Melamine EUR	Painted EUR	Veneer EUR
1	BBN2022560110080.	2.050,30	2.337,30	3.103,80
2	BBN2022560210080.	3.862,90	4.395,40	5.816,20
3	BBN2022560310080.	6.637,20	7.584,40	10.112,20

H1820 mm

No. of bays	Item no.	Melamine EUR	Painted EUR	Veneer EUR
1	BBN2022660110080.	2.289,00	2.604,00	3.442,50
2	BBN2022660210080.	4.262,70	4.837,20	6.366,00
3	BBN2022660310080.	7.198,10	8.201,30	10.873,10

H2120 mm

No. of bays	Item no.	Melamine EUR	Painted EUR	Veneer EUR
1	BBN2022760110080.	2.522,40	2.863,60	3.772,90
2	BBN2022760210080.	4.654,50	5.268,30	6.903,30
3	BBN2022760310080.	7.748,30	8.803,90	11.617,30

LINGO ROUND SHELVING SYSTEM

26° - STEEL BACK PANEL - ADJUSTABLE FEET - WITH TOP PLATE - RIGHT STARTER SECTION

Painted and veneered Lingo Shelving Systems are FSC-certified.

H720 mm

No. of bays	Item no.	Melamine EUR	Painted EUR	Veneer EUR
1	BBN2023260110080.	1.461,10	1.683,10	2.276,60
2	BBN2023260210080.	2.867,80	3.302,80	4.464,10
3	BBN2023260310080.	4.471,80	5.154,20	6.976,40

H920 mm

No. of bays	Item no.	Melamine EUR	Painted EUR	Veneer EUR
1	BBN2023360110080.	1.652,70	1.899,30	2.556,60
2	BBN2023360210080.	3.183,00	3.654,90	4.911,90
3	BBN2023360310080.	4.910,60	5.642,20	7.592,00

H1220 mm

No. of bays	Item no.	Melamine EUR	Painted EUR	Veneer EUR
1	BBN2023460110080.	1.923,50	2.202,70	2.948,80
2	BBN2023460210080.	3.631,00	4.151,80	5.542,00
3	BBN2023460310080.	5.535,80	6.332,60	8.460,00

H1520 mm

No. of bays	Item no.	Melamine EUR	Painted EUR	Veneer EUR
1	BBN2023560110080.	2.050,30	2.337,30	3.103,80
2	BBN2023560210080.	3.862,90	4.395,40	5.816,20
3	BBN2023560310080.	5.872,80	6.685,20	8.853,40

H1820 mm

No. of bays	Item no.	Melamine EUR	Painted EUR	Veneer EUR
1	BBN2023660110080.	2.289,00	2.604,00	3.442,50
2	BBN2023660210080.	4.262,70	4.837,20	6.366,00
3	BBN2023660310080.	6.433,70	7.302,10	9.614,30

H2120 mm

No. of bays	Item no.	Melamine EUR	Painted EUR	Veneer EUR
1	BBN2023760110080.	2.522,40	2.863,60	3.772,90
2	BBN2023760210080.	4.654,50	5.268,30	6.903,30
3	BBN2023760310080.	6.983,90	7.904,70	10.358,50

LINGO ROUND SHELVING SYSTEM

26° - STEEL BACK PANEL - ADJUSTABLE FEET - WITH TOP PLATE - INTERMEDIATE SECTION

Painted and veneered Lingo Shelving Systems are FSC-certified.

H720 mm

No. of bays	Item no.	Melamine EUR	Painted EUR	Veneer EUR
1	BBN2024260110080.	1.209,50	1.387,30	1.862,20
2	BBN2024260210080.	2.591,20	2.977,30	4.008,30
3	BBN2024260310080.	4.974,80	5.745,70	7.804,10

H920 mm

No. of bays	Item no.	Melamine EUR	Painted EUR	Veneer EUR
1	BBN2024360110080.	1.333,10	1.523,20	2.030,00
2	BBN2024360210080.	2.838,40	3.249,10	4.343,90
3	BBN2024360310080.	5.345,60	6.153,40	8.307,50

H1220 mm

No. of bays	Item no.	Melamine EUR	Painted EUR	Veneer EUR
1	BBN2024460110080.	1.510,30	1.716,70	2.267,90
2	BBN2024460210080.	3.192,80	3.636,10	4.819,70
3	BBN2024460310080.	5.877,20	6.733,90	9.021,20

H1520 mm

No. of bays	Item no.	Melamine EUR	Painted EUR	Veneer EUR
1	BBN2024560110080.	1.615,40	1.825,70	2.387,10
2	BBN2024560210080.	3.403,00	3.854,10	5.058,10
3	BBN2024560310080.	6.192,50	7.060,90	9.378,80

H1820 mm

No. of bays	Item no.	Melamine EUR	Painted EUR	Veneer EUR
1	BBN2024660110080.	1.776,50	2.000,80	2.598,20
2	BBN2024660210080.	3.725,20	4.204,30	5.480,30
3	BBN2024660310080.	6.675,80	7.586,20	10.012,10

H2120 mm

No. of bays	Item no.	Melamine EUR	Painted EUR	Veneer EUR
1	BBN2024760110080.	1.934,90	2.172,30	2.805,10
2	BBN2024760210080.	4.042,00	4.547,30	5.894,10
3	BBN2024760310080.	7.151,00	8.100,70	10.632,80

LINGO ROUND SHELVING SYSTEM

26° - STEEL BACK PANEL - ADJUSTABLE FEET - WITH TOP PLATE - LEFT END SECTION

Painted and veneered Lingo Shelving Systems are FSC-certified.

H720 mm

No. of bays	Item no.	Melamine EUR	Painted EUR	Veneer EUR
1	BBN2025260110080.	971,90	1.107,90	1.470,80
2	BBN2025260210080.	2.623,20	3.015,20	4.061,20
3	BBN2025260310080.	4.991,60	5.765,80	7.832,30

H920 mm

No. of bays	Item no.	Melamine EUR	Painted EUR	Veneer EUR
1	BBN2025360110080.	1.027,50	1.163,50	1.526,40
2	BBN2025360210080.	2.870,40	3.287,00	4.396,80
3	BBN2025360310080.	5.362,40	6.173,50	8.335,70

H1220 mm

No. of bays	Item no.	Melamine EUR	Painted EUR	Veneer EUR
1	BBN2025460110080.	1.111,10	1.247,10	1.610,00
2	BBN2025460210080.	3.224,80	3.674,00	4.872,60
3	BBN2025460310080.	5.894,00	6.754,00	9.049,40

H1520 mm

No. of bays	Item no.	Melamine EUR	Painted EUR	Veneer EUR
1	BBN2025560110080.	1.194,50	1.330,50	1.693,40
2	BBN2025560210080.	3.435,00	3.892,00	5.111,00
3	BBN2025560310080.	6.209,30	7.081,00	9.407,00

H1820 mm

No. of bays	Item no.	Melamine EUR	Painted EUR	Veneer EUR
1	BBN2025660110080.	1.278,00	1.414,00	1.776,90
2	BBN2025660210080.	3.757,20	4.242,20	5.533,20
3	BBN2025660310080.	6.692,60	7.606,30	10.040,30

H2120 mm

No. of bays	Item no.	Melamine EUR	Painted EUR	Veneer EUR
1	BBN2025760110080.	1.361,40	1.497,40	1.860,30
2	BBN2025760210080.	4.074,00	4.585,20	5.947,00
3	BBN2025760310080.	7.167,80	8.120,80	10.661,00

LINGO ROUND SHELVING SYSTEM

26° - STEEL BACK PANEL - ADJUSTABLE FEET - WITH TOP PLATE - RIGHT END SECTION

Painted and veneered Lingo Shelving Systems are FSC-certified.

H720 mm

No. of bays	Item no.	Melamine EUR	Painted EUR	Veneer EUR
1	BBN2026260110080.	971,90	1.107,90	1.470,80
2	BBN2026260210080.	2.623,20	3.015,20	4.061,20
3	BBN2026260310080.	4.227,20	4.866,60	6.573,50

H920 mm

No. of bays	Item no.	Melamine EUR	Painted EUR	Veneer EUR
1	BBN2026360110080.	1.027,50	1.163,50	1.526,40
2	BBN2026360210080.	2.870,40	3.287,00	4.396,80
3	BBN2026360310080.	4.598,00	5.274,30	7.076,90

H1220 mm

No. of bays	Item no.	Melamine EUR	Painted EUR	Veneer EUR
1	BBN2026460110080.	1.111,10	1.247,10	1.610,00
2	BBN2026460210080.	3.224,80	3.674,00	4.872,60
3	BBN2026460310080.	5.129,60	5.854,80	7.790,60

H1520 mm

No. of bays	Item no.	Melamine EUR	Painted EUR	Veneer EUR
1	BBN2026560110080.	1.194,50	1.330,50	1.693,40
2	BBN2026560210080.	3.435,00	3.892,00	5.111,00
3	BBN2026560310080.	5.444,90	6.181,80	8.148,20

H1820 mm

No. of bays	Item no.	Melamine EUR	Painted EUR	Veneer EUR
1	BBN2026660110080.	1.278,00	1.414,00	1.776,90
2	BBN2026660210080.	3.757,20	4.242,20	5.533,20
3	BBN2026660310080.	5.928,20	6.707,10	8.781,50

H2120 mm

No. of bays	Item no.	Melamine EUR	Painted EUR	Veneer EUR
1	BBN2026760110080.	1.361,40	1.497,40	1.860,30
2	BBN2026760210080.	4.074,00	4.585,20	5.947,00
3	BBN2026760310080.	6.403,40	7.221,60	9.402,20

LINGO ROUND SHELVING SYSTEM

BBN211 - 26° - STEEL BACK FRAME - CASTOR PLATE - FOR TOP SHELF



LINGO ROUND SHELVING SYSTEM

BBN211 - 26° - STEEL BACK FRAME - CASTOR PLATE - FOR TOP SHELF

Round shelving system with wooden panels, steel back frame and castor plate. To be used with top shelf.

- Prices based on steel price group 1 and wooden price group A (see Design Options pages 6-9).
- For top shelves, see from page 340
- For shelves, see from page 328

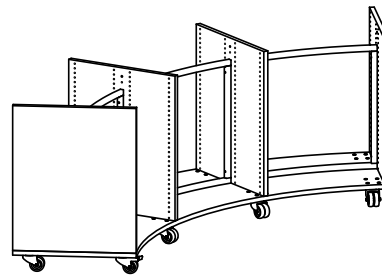
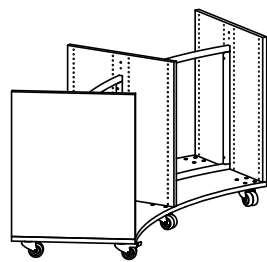
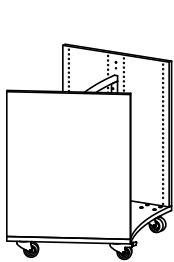

Double-sided H920 mm - 1/2/3 bays

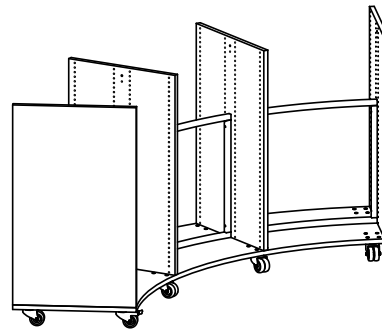
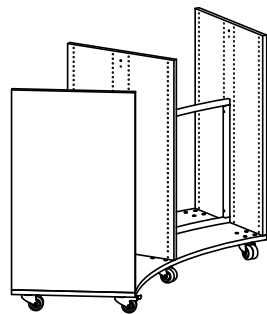
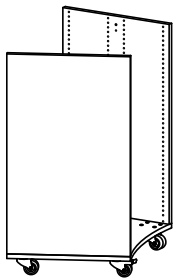

Double-sided H1220 mm - 1/2/3 bays

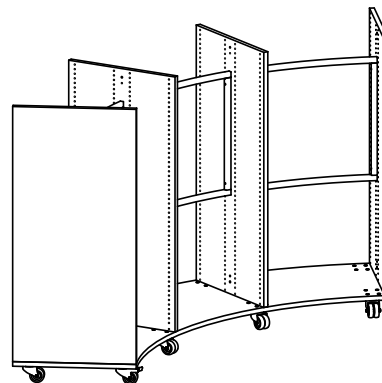
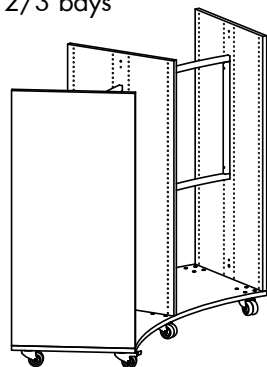
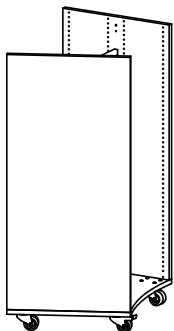

Double-sided H1520 mm - 1/2/3 bays

LINGO ROUND SHELVING SYSTEM

26° - STEEL BACK FRAME - CASTOR PLATE - FOR TOP SHELF

Painted and veneered Lingo Shelving Systems are FSC-certified.

H920 mm

No. of bays	Item no.	Melamine EUR	Painted EUR	Veneer EUR
1	BBN211136010006.	2.019,10	2.328,60	3.153,30
2	BBN211136020006.	3.679,70	4.235,20	5.715,70
3	BBN211136030006.	5.259,70	6.046,80	8.144,90

H1220 mm

No. of bays	Item no.	Melamine EUR	Painted EUR	Veneer EUR
1	BBN211146010006.	2.206,30	2.548,40	3.461,90
2	BBN211146020006.	3.960,50	4.564,90	6.178,60
3	BBN211146030006.	5.634,10	6.486,40	8.762,10

H1520 mm

No. of bays	Item no.	Melamine EUR	Painted EUR	Veneer EUR
1	BBN211156010006.	2.249,70	2.599,60	3.533,50
2	BBN211156020006.	4.025,60	4.641,70	6.286,00
3	BBN211156030006.	5.720,90	6.588,80	8.905,30

LINGO ROUND SHELVING SYSTEM

26° - STEEL BACK FRAME - CASTOR PLATE - FOR TOP SHELF

LINGO ROUND SHELVING SYSTEM

BBN211 - 26° - HIGH STEEL BACK PANEL - CASTOR PLATE - FOR TOP SHELF



LINGO ROUND SHELVING SYSTEM

BBN211 - 26° - HIGH STEEL BACK PANEL - CASTOR PLATE - FOR TOP SHELF

Round shelving system with wooden panels, high steel back panel and castor plate.
To be used with top shelves WT5 standard depth top shelf.

- Prices based on steel price group 1 and wooden price group A (see Design Options pages 6-9).
- For top shelves, see from page 340
- For shelves, see from page 328

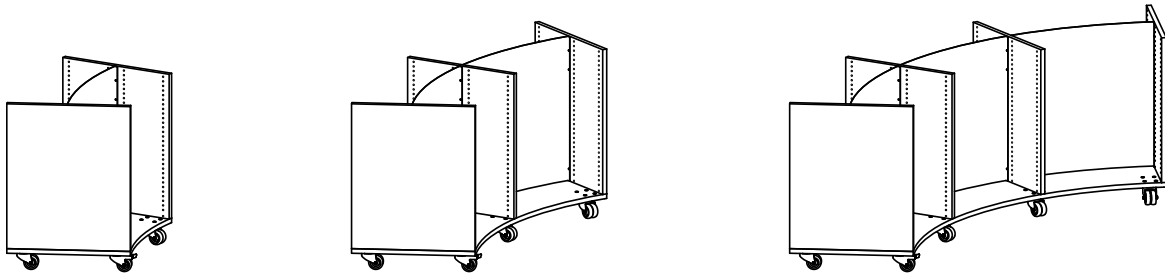

Double-sided H920 mm - 1/2/3 bays

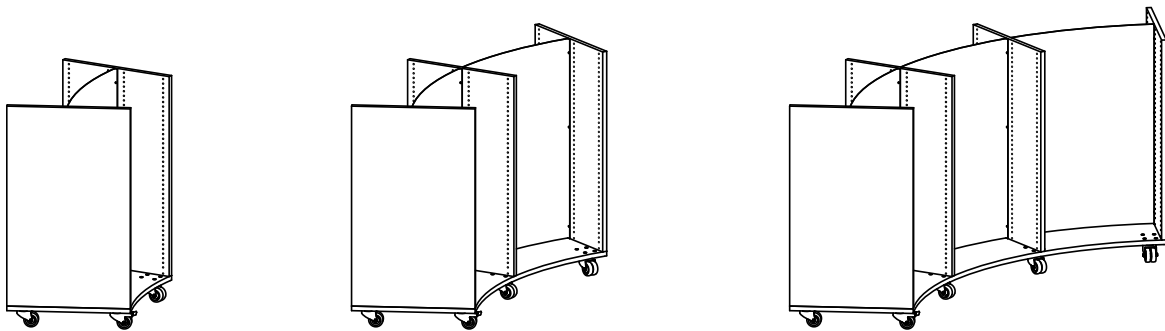

Double-sided H1220 mm - 1/2/3 bays

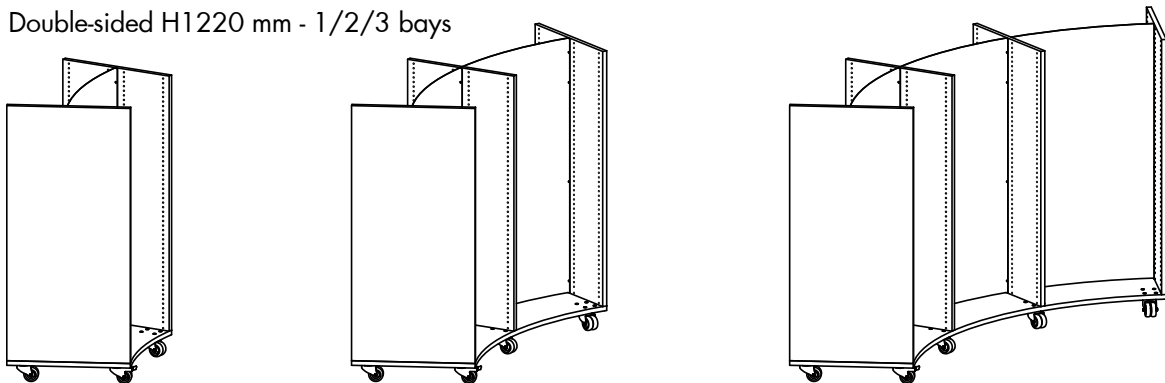

Double-sided H1520 mm - 1/2/3 bays

LINGO ROUND SHELVING SYSTEM

26° - HIGH STEEL BACK PANEL - CASTOR PLATE - FOR TOP SHELF

Painted and veneered Lingo Shelving Systems are FSC-certified.

H920 mm

No. of bays	Item no.	Melamine EUR	Painted EUR	Veneer EUR
1	BBN211136010008.	2.008,00	2.317,50	3.142,20
2	BBN211136020008.	3.657,50	4.213,00	5.693,50
3	BBN211136030008.	5.226,40	6.013,50	8.111,60

H1220 mm

No. of bays	Item no.	Melamine EUR	Painted EUR	Veneer EUR
1	BBN211146010008.	2.278,80	2.620,90	3.534,40
2	BBN211146020008.	4.105,50	4.709,90	6.323,60
3	BBN211146030008.	5.851,60	6.703,90	8.979,60

H1520 mm

No. of bays	Item no.	Melamine EUR	Painted EUR	Veneer EUR
1	BBN211156010008.	2.405,60	2.755,50	3.689,40
2	BBN211156020008.	4.337,40	4.953,50	6.597,80
3	BBN211156030008.	6.188,60	7.056,50	9.373,00

LINGO ROUND SHELVING SYSTEM

26° - HIGH STEEL BACK PANEL - CASTOR PLATE - FOR TOP SHELF

LINGO ROUND SHELVING SYSTEM

BBN211 - 26° - LOW STEEL BACK PANEL - CASTOR PLATE - FOR TOP SHELF



LINGO ROUND SHELVING SYSTEM

BBN211 - 26° - LOW STEEL BACK PANEL - CASTOR PLATE - FOR TOP SHELF

Round shelving system with wooden panels, low steel back panel and castor plate.
To be used with top shelves WT5 full depth and WT5 double-sided top shelf.

- Prices based on steel price group 1 and wooden price group A (see Design Options pages 6-9).
- For top shelves, see from page 340
- For shelves, see from page 328
- For slat panels, see from page 351 (note slate panel replaces outer panel)

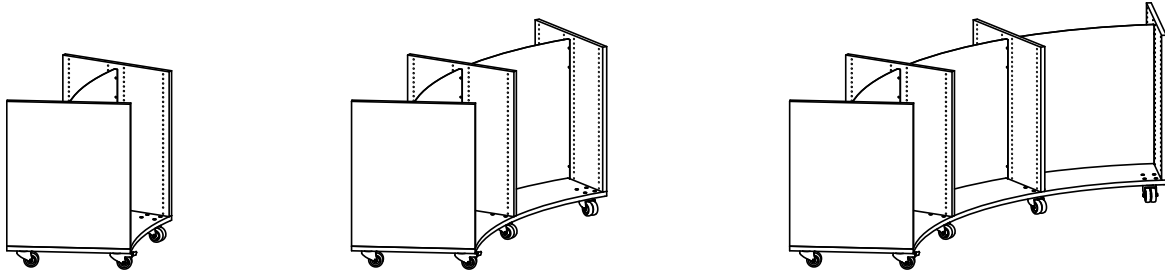

Double-sided H920 mm - 1/2/3 bays

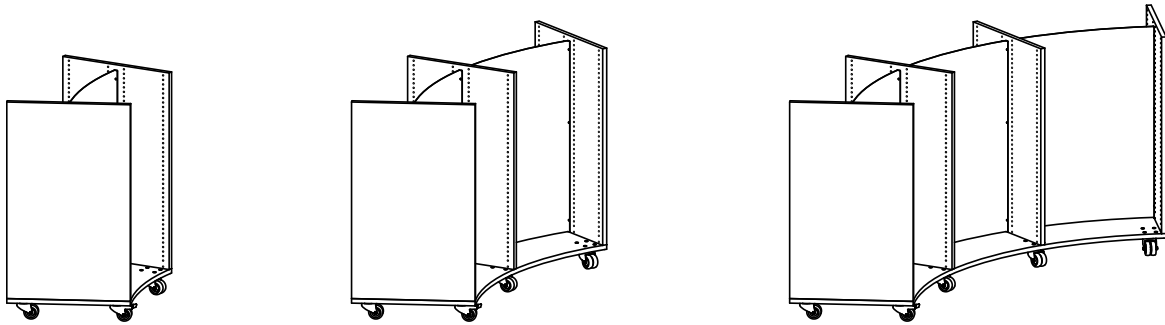

Double-sided H1220 mm - 1/2/3 bays

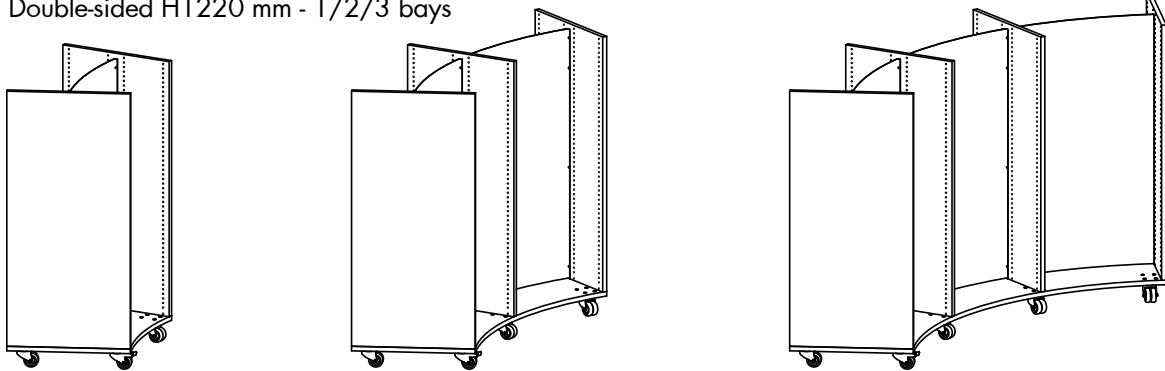

Double-sided H1520 mm - 1/2/3 bays

LINGO ROUND SHELVING SYSTEM

26° - LOW STEEL BACK PANEL - CASTOR PLATE - FOR TOP SHELF

Painted and veneered Lingo Shelving Systems are FSC-certified.

H920 mm

No. of bays	Item no.	Melamine EUR	Painted EUR	Veneer EUR
1	BBN211136010007.	2.008,00	2.317,50	3.142,20
2	BBN211136020007.	3.657,50	4.213,00	5.693,50
3	BBN211136030007.	5.226,40	6.013,50	8.111,60

H1220 mm

No. of bays	Item no.	Melamine EUR	Painted EUR	Veneer EUR
1	BBN211146010007.	2.278,80	2.620,90	3.534,40
2	BBN211146020007.	4.105,50	4.709,90	6.323,60
3	BBN211146030007.	5.851,60	6.703,90	8.979,60

H1520 mm

No. of bays	Item no.	Melamine EUR	Painted EUR	Veneer EUR
1	BBN211156010007.	2.405,60	2.755,50	3.689,40
2	BBN211156020007.	4.337,40	4.953,50	6.597,80
3	BBN211156030007.	6.188,60	7.056,50	9.373,00

LINGO ROUND SHELVING SYSTEM

26° - LOW STEEL BACK PANEL - CASTOR PLATE - FOR TOP SHELF

LINGO ROUND SHELVING SYSTEM

BBN212 - 26° - STEEL BACK FRAME - CASTOR PLATE - WITH OVERLAYING TOP PLATE



LINGO ROUND SHELVING SYSTEM

BBN212 - 26° - STEEL BACK FRAME - CASTOR PLATE - WITH OVERLAYING TOP PLATE

Round shelving system with wooden panels, steel back frame, castor plate and overlaying top plate.

- Prices based on steel price group 1 and wooden price group A (see Design Options pages 6-9).
- For shelves, see from page 328

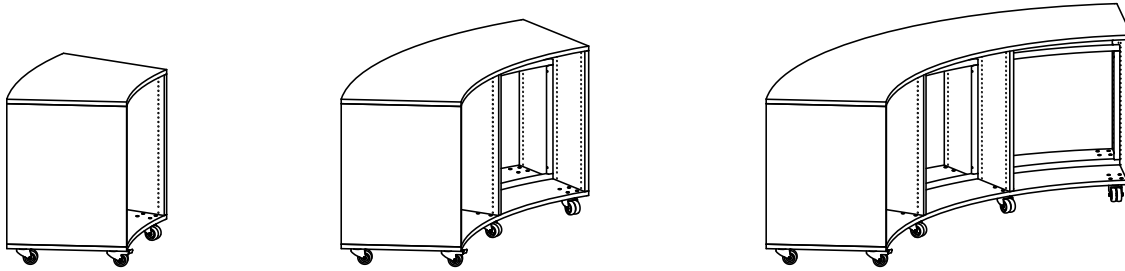

Double-sided H920 mm - 1/2/3 bays

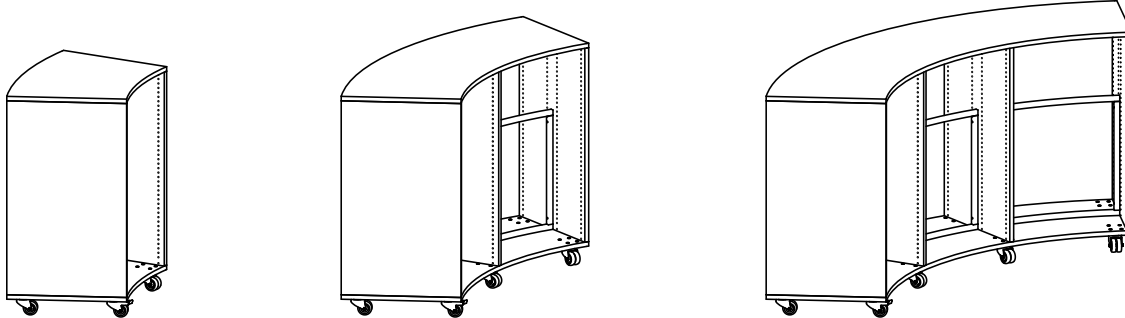

Double-sided H1220 mm - 1/2/3 bays

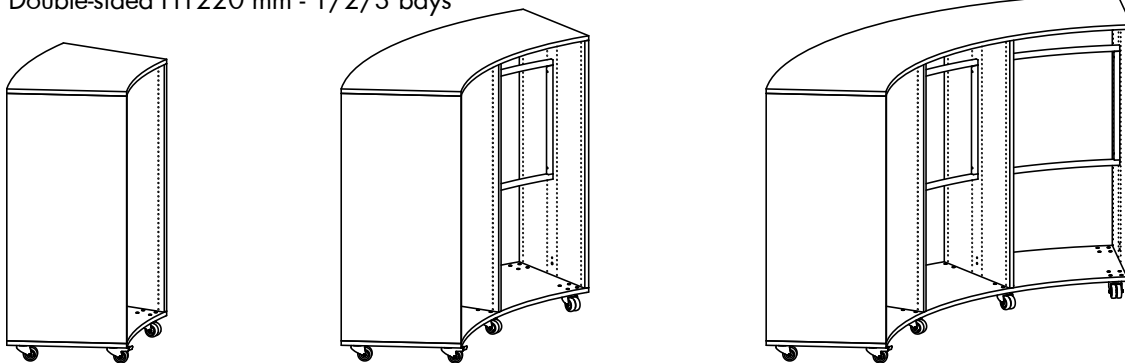

Double-sided H1520 mm - 1/2/3 bays

LINGO ROUND SHELVING SYSTEM

26° - STEEL BACK FRAME - CASTOR PLATE - WITH OVERLAYING TOP PLATE

Painted and veneered Lingo Shelving Systems are FSC-certified.

H920 mm

No. of bays	Item no.	Melamine EUR	Painted EUR	Veneer EUR
1	BBN212136011006.	2.792,90	3.238,80	4.427,90
2	BBN212136021006.	5.414,50	6.276,00	8.572,90
3	BBN212136031006.	8.153,20	9.450,70	12.910,40

H1220 mm

No. of bays	Item no.	Melamine EUR	Painted EUR	Veneer EUR
1	BBN212146011006.	2.980,10	3.458,60	4.736,50
2	BBN212146021006.	5.695,30	6.605,70	9.035,80
3	BBN212146031006.	8.527,60	9.890,30	13.527,60

H1520 mm

No. of bays	Item no.	Melamine EUR	Painted EUR	Veneer EUR
1	BBN212156011006.	3.023,50	3.509,80	4.808,10
2	BBN212156021006.	5.760,40	6.682,50	9.143,20
3	BBN212156031006.	8.614,40	9.992,70	13.670,80

LINGO ROUND SHELVING SYSTEM

26° - STEEL BACK FRAME - CASTOR PLATE - WITH OVERLAYING TOP PLATE

LINGO ROUND SHELVING SYSTEM

BBN212 - 26° - STEEL BACK PANEL - CASTOR PLATE - WITH OVERLAYING TOP PLATE



LINGO ROUND SHELVING SYSTEM

BBN212 - 26° - STEEL BACK PANEL - CASTOR PLATE - WITH OVERLAYING TOP PLATE

Round shelving system with wooden panels, steel back panel, castor plate and overlaying top plate.

- Prices based on steel price group 1 and wooden price group A (see Design Options pages 6-9).
- For shelves, see from page 328

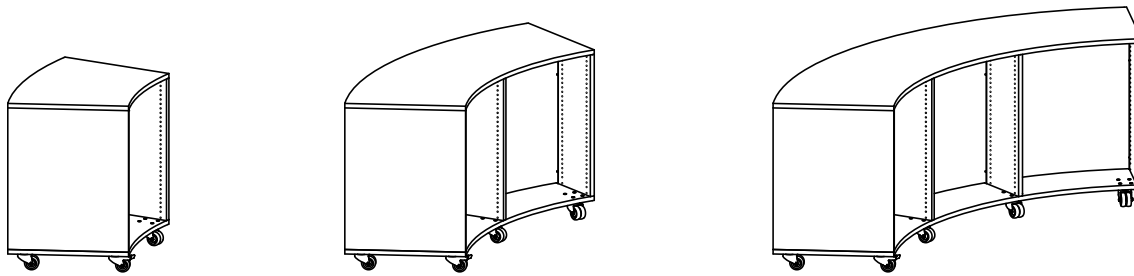

Double-sided H920 mm - 1/2/3 bays

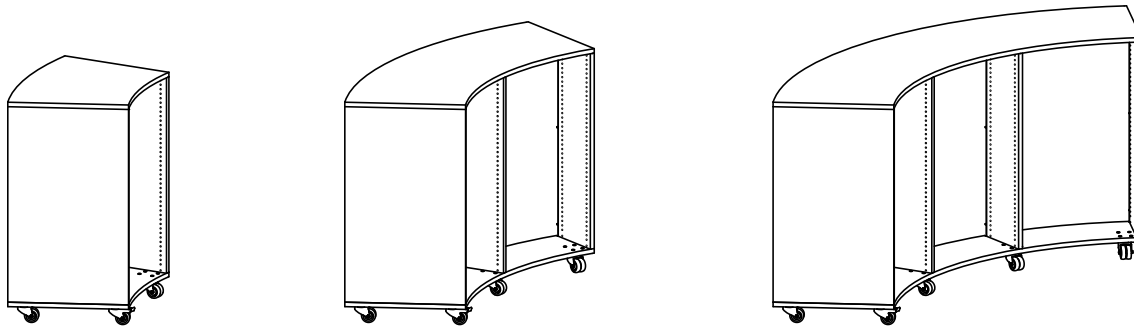

Double-sided H1220 mm - 1/2/3 bays

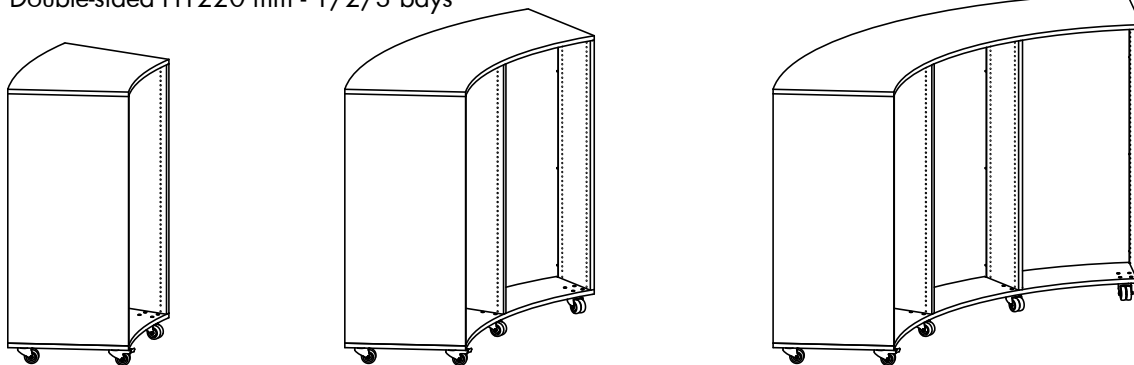

Double-sided H1520 mm - 1/2/3 bays

LINGO ROUND SHELVING SYSTEM

26° - STEEL BACK PANEL - CASTOR PLATE - WITH OVERLAYING TOP PLATE

Painted and veneered Lingo Shelving Systems are FSC-certified.

H920 mm

No. of bays	Item no.	Melamine EUR	Painted EUR	Veneer EUR
1	BBN212136011008.	2.781,80	3.227,70	4.416,80
2	BBN212136021008.	5.392,30	6.253,80	8.550,70
3	BBN212136031008.	8.119,90	9.417,40	12.877,10

H1220 mm

No. of bays	Item no.	Melamine EUR	Painted EUR	Veneer EUR
1	BBN212146011008.	3.052,60	3.531,10	4.809,00
2	BBN212146021008.	5.840,30	6.750,70	9.180,80
3	BBN212146031008.	8.745,10	10.107,80	13.745,10

H1520 mm

No. of bays	Item no.	Melamine EUR	Painted EUR	Veneer EUR
1	BBN212156011008.	3.179,40	3.665,70	4.964,00
2	BBN212156021008.	6.072,20	6.994,30	9.455,00
3	BBN212156031008.	9.082,10	10.460,40	14.138,50

LINGO ROUND SHELVING SYSTEM

26° - STEEL BACK PANEL - CASTOR PLATE - WITH OVERLAYING TOP PLATE

LINGO ROUND SHELVING SYSTEM

BBN221 - 18° - STEEL BACK FRAME - ADJUSTABLE FEET - FOR TOP SHELF



LINGO ROUND SHELVING SYSTEM

BBN221 - 18° - STEEL BACK FRAME - ADJUSTABLE FEET - FOR TOP SHELF

Round shelving system with wooden panels and steel back frame. To be used with top shelf.
Freestanding bay includes 2 end wooden panels and 1 or 2 steel back frame depending on height.
Intermediate bay includes 1 intermediate wooden panel and 1 steel back frame.

- Prices based on steel price group 1 and wooden price group A (see Design Options pages 6-9).
- For top shelves, see from page 340
- For shelves, see from page 328

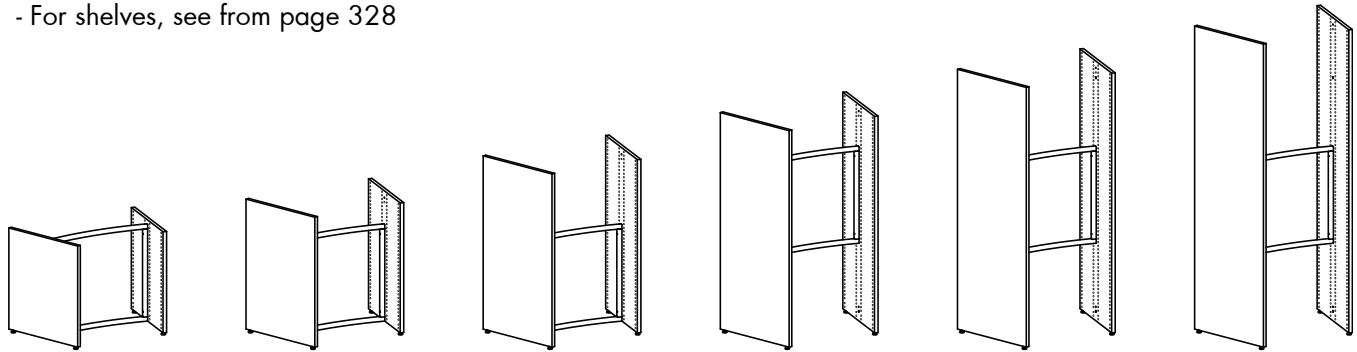

Double-sided freestanding bay - H720/920/1220/1520/1820/2120 mm

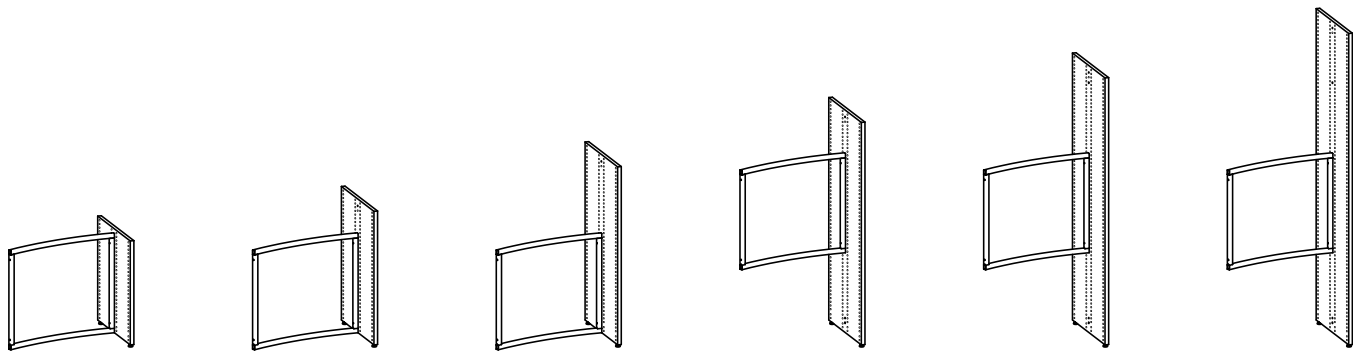

Double-sided intermediate bay - H720/920/1220/1520/1820/2120 mm

LINGO ROUND SHELVING SYSTEM

18° - STEEL BACK FRAME - ADJUSTABLE FEET - FOR TOP SHELF

Painted and veneered Lingo Shelving Systems are FSC-certified.

H720 mm

No. of bays	Item no. Freestanding bay	Melamine EUR	Painted EUR	Veneer EUR	Item no. Intermediate bay	Melamine EUR	Painted EUR	Veneer EUR
1	BBN2211260100060.	756,40	842,40	1.109,80	BBN2214260100060.	511,80	554,80	670,10
2	BBN2211260200060.	1.268,20	1.397,20	1.779,90	BBN2214260200060.	1.023,60	1.109,60	1.340,20
3	BBN2211260300060.	1.780,00	1.952,00	2.450,00	BBN2214260300060.	1.535,40	1.664,40	2.010,30
4	BBN2211260400060.	2.291,80	2.506,80	3.120,10	BBN2214260400060.	2.047,20	2.219,20	2.680,40
5	BBN2211260500060.	2.803,60	3.061,60	3.790,20	BBN2214260500060.	2.559,00	2.774,00	3.350,50
6	BBN2211260600060.	3.315,40	3.616,40	4.460,30	BBN2214260600060.	3.070,80	3.328,80	4.020,60
7	BBN2211260700060.	3.827,20	4.171,20	5.130,40	BBN2214260700060.	3.582,60	3.883,60	4.690,70
8	BBN2211260800060.	4.339,00	4.726,00	5.800,50	BBN2214260800060.	4.094,40	4.438,40	5.360,80
9	BBN2211260900060.	4.850,80	5.280,80	6.470,60	BBN2214260900060.	4.606,20	4.993,20	6.030,90
10	BBN2211261000060.	5.362,60	5.835,60	7.140,70	BBN2214261000060.	5.118,00	5.548,00	6.701,00
11	BBN2211261100060.	5.874,40	6.390,40	7.810,80				
12	BBN2211261200060.	6.386,20	6.945,20	8.480,90				
13	BBN2211261300060.	6.898,00	7.500,00	9.151,00				
14	BBN2211261400060.	7.409,80	8.054,80	9.821,10				
15	BBN2211261500060.	7.921,60	8.609,60	10.491,20				
16	BBN2211261600060.	8.433,40	9.164,40	11.161,30				
17	BBN2211261700060.	8.945,20	9.719,20	11.831,40				
18	BBN2211261800060.	9.457,00	10.274,00	12.501,50				

H920 mm

No. of bays	Item no. Freestanding bay	Melamine EUR	Painted EUR	Veneer EUR	Item no. Intermediate bay	Melamine EUR	Painted EUR	Veneer EUR
1	BBN2211360100060.	892,40	1.003,00	1.297,40	BBN2214360100060.	579,80	635,10	782,30
2	BBN2211360200060.	1.472,20	1.638,10	2.079,70	BBN2214360200060.	1.159,60	1.270,20	1.564,60
3	BBN2211360300060.	2.052,00	2.273,20	2.862,00	BBN2214360300060.	1.739,40	1.905,30	2.346,90
4	BBN2211360400060.	2.631,80	2.908,30	3.644,30	BBN2214360400060.	2.319,20	2.540,40	3.129,20
5	BBN2211360500060.	3.211,60	3.543,40	4.426,60	BBN2214360500060.	2.899,00	3.175,50	3.911,50
6	BBN2211360600060.	3.791,40	4.178,50	5.208,90	BBN2214360600060.	3.478,80	3.810,60	4.693,80
7	BBN2211360700060.	4.371,20	4.813,60	5.991,20	BBN2214360700060.	4.058,60	4.445,70	5.476,10
8	BBN2211360800060.	4.951,00	5.448,70	6.773,50	BBN2214360800060.	4.638,40	5.080,80	6.258,40
9	BBN2211360900060.	5.530,80	6.083,80	7.555,80	BBN2214360900060.	5.218,20	5.715,90	7.040,70
10	BBN2211361000060.	6.110,60	6.718,90	8.338,10	BBN2214361000060.	5.798,00	6.351,00	7.823,00
11	BBN2211361100060.	6.690,40	7.354,00	9.120,40				
12	BBN2211361200060.	7.270,20	7.989,10	9.902,70				
13	BBN2211361300060.	7.850,00	8.624,20	10.685,00				
14	BBN2211361400060.	8.429,80	9.259,30	11.467,30				
15	BBN2211361500060.	9.009,60	9.894,40	12.249,60				
16	BBN2211361600060.	9.589,40	10.529,50	13.031,90				
17	BBN2211361700060.	10.169,20	11.164,60	13.814,20				
18	BBN2211361800060.	10.749,00	11.799,70	14.596,50				

H1220 mm

No. of bays	Item no. Freestanding bay	Melamine EUR	Painted EUR	Veneer EUR	Item no. Intermediate bay	Melamine EUR	Painted EUR	Veneer EUR
1	BBN2211460100060.	1.079,60	1.222,80	1.606,00	BBN2214460100060.	673,40	745,00	936,60
2	BBN2211460200060.	1.753,00	1.967,80	2.542,60	BBN2214460200060.	1.346,80	1.490,00	1.873,20
3	BBN2211460300060.	2.426,40	2.712,80	3.479,20	BBN2214460300060.	2.020,20	2.235,00	2.809,80
4	BBN2211460400060.	3.099,80	3.457,80	4.415,80	BBN2214460400060.	2.693,60	2.980,00	3.746,40
5	BBN2211460500060.	3.773,20	4.202,80	5.352,40	BBN2214460500060.	3.367,00	3.725,00	4.683,00
6	BBN2211460600060.	4.446,60	4.947,80	6.289,00	BBN2214460600060.	4.040,40	4.470,00	5.619,60
7	BBN2211460700060.	5.120,00	5.692,80	7.225,60	BBN2214460700060.	4.713,80	5.215,00	6.556,20
8	BBN2211460800060.	5.793,40	6.437,80	8.162,20	BBN2214460800060.	5.387,20	5.960,00	7.492,80
9	BBN2211460900060.	6.466,80	7.182,80	9.098,80	BBN2214460900060.	6.060,60	6.705,00	8.429,40
10	BBN2211461000060.	7.140,20	7.927,80	10.035,40	BBN2214461000060.	6.734,00	7.450,00	9.366,00
11	BBN2211461100060.	7.813,60	8.672,80	10.972,00				
12	BBN2211461200060.	8.487,00	9.417,80	11.908,60				
13	BBN2211461300060.	9.160,40	10.162,80	12.845,20				
14	BBN2211461400060.	9.833,80	10.907,80	13.781,80				
15	BBN2211461500060.	10.507,20	11.652,80	14.718,40				
16	BBN2211461600060.	11.180,60	12.397,80	15.655,00				
17	BBN2211461700060.	11.854,00	13.142,80	16.591,60				
18	BBN2211461800060.	12.527,40	13.887,80	17.528,20				

LINGO ROUND SHELVING SYSTEM

18° - STEEL BACK FRAME - ADJUSTABLE FEET - FOR TOP SHELF

Painted and veneered Lingo Shelving Systems are FSC-certified.

H1520 mm

No. of bays	Item no. Freestanding bay	Melamine EUR	Painted EUR	Veneer EUR	Item no. Intermediate bay	Melamine EUR	Painted EUR	Veneer EUR
1	BBN2211560100060.	1.123,00	1.274,00	1.677,60	BBN2214560100060.	695,10	770,60	972,40
2	BBN2211560200060.	1.818,10	2.044,60	2.650,00	BBN2214560200060.	1.390,20	1.541,20	1.944,80
3	BBN2211560300060.	2.513,20	2.815,20	3.622,40	BBN2214560300060.	2.085,30	2.311,80	2.917,20
4	BBN2211560400060.	3.208,30	3.585,80	4.594,80	BBN2214560400060.	2.780,40	3.082,40	3.889,60
5	BBN2211560500060.	3.903,40	4.356,40	5.567,20	BBN2214560500060.	3.475,50	3.853,00	4.862,00
6	BBN2211560600060.	4.598,50	5.127,00	6.539,60	BBN2214560600060.	4.170,60	4.623,60	5.834,40
7	BBN2211560700060.	5.293,60	5.897,60	7.512,00	BBN2214560700060.	4.865,70	5.394,20	6.806,80
8	BBN2211560800060.	5.988,70	6.668,20	8.484,40	BBN2214560800060.	5.560,80	6.164,80	7.779,20
9	BBN2211560900060.	6.683,80	7.438,80	9.456,80	BBN2214560900060.	6.255,90	6.935,40	8.751,60
10	BBN2211561000060.	7.378,90	8.209,40	10.429,20	BBN2214561000060.	6.951,00	7.706,00	9.724,00
11	BBN2211561100060.	8.074,00	8.980,00	11.401,60				
12	BBN2211561200060.	8.769,10	9.750,60	12.374,00				
13	BBN2211561300060.	9.464,20	10.521,20	13.346,40				
14	BBN2211561400060.	10.159,30	11.291,80	14.318,80				
15	BBN2211561500060.	10.854,40	12.062,40	15.291,20				
16	BBN2211561600060.	11.549,50	12.833,00	16.263,60				
17	BBN2211561700060.	12.244,60	13.603,60	17.236,00				
18	BBN2211561800060.	12.939,70	14.374,20	18.208,40				

H1820 mm

No. of bays	Item no. Freestanding bay	Melamine EUR	Painted EUR	Veneer EUR	Item no. Intermediate bay	Melamine EUR	Painted EUR	Veneer EUR
1	BBN2211660100060.	1.278,20	1.457,20	1.932,80	BBN2214660100060.	772,70	862,20	1.100,00
2	BBN2211660200060.	2.050,90	2.319,40	3.032,80	BBN2214660200060.	1.545,40	1.724,40	2.200,00
3	BBN2211660300060.	2.823,60	3.181,60	4.132,80	BBN2214660300060.	2.318,10	2.586,60	3.300,00
4	BBN2211660400060.	3.596,30	4.043,80	5.232,80	BBN2214660400060.	3.090,80	3.448,80	4.400,00
5	BBN2211660500060.	4.369,00	4.906,00	6.332,80	BBN2214660500060.	3.863,50	4.311,00	5.500,00
6	BBN2211660600060.	5.141,70	5.768,20	7.432,80	BBN2214660600060.	4.636,20	5.173,20	6.600,00
7	BBN2211660700060.	5.914,40	6.630,40	8.532,80	BBN2214660700060.	5.408,90	6.035,40	7.700,00
8	BBN2211660800060.	6.687,10	7.492,60	9.632,80	BBN2214660800060.	6.181,60	6.897,60	8.800,00
9	BBN2211660900060.	7.459,80	8.354,80	10.732,80	BBN2214660900060.	6.954,30	7.759,80	9.900,00
10	BBN2211661000060.	8.232,50	9.217,00	11.832,80	BBN2214661000060.	7.727,00	8.622,00	11.000,00
11	BBN2211661100060.	9.005,20	10.079,20	12.932,80				
12	BBN2211661200060.	9.777,90	10.941,40	14.032,80				
13	BBN2211661300060.	10.550,60	11.803,60	15.132,80				
14	BBN2211661400060.	11.323,30	12.665,80	16.232,80				
15	BBN2211661500060.	12.096,00	13.528,00	17.332,80				
16	BBN2211661600060.	12.868,70	14.390,20	18.432,80				
17	BBN2211661700060.	13.641,40	15.252,40	19.532,80				
18	BBN2211661800060.	14.414,10	16.114,60	20.632,80				

H2120 mm

No. of bays	Item no. Freestanding bay	Melamine EUR	Painted EUR	Veneer EUR	Item no. Intermediate bay	Melamine EUR	Painted EUR	Veneer EUR
1	BBN2211760100060.	1.428,20	1.633,40	2.179,80	BBN2214760100060.	847,70	950,30	1.223,50
2	BBN2211760200060.	2.275,90	2.583,70	3.403,30	BBN2214760200060.	1.695,40	1.900,60	2.447,00
3	BBN2211760300060.	3.123,60	3.534,00	4.626,80	BBN2214760300060.	2.543,10	2.850,90	3.670,50
4	BBN2211760400060.	3.971,30	4.484,30	5.850,30	BBN2214760400060.	3.390,80	3.801,20	4.894,00
5	BBN2211760500060.	4.819,00	5.434,60	7.073,80	BBN2214760500060.	4.238,50	4.751,50	6.117,50
6	BBN2211760600060.	5.666,70	6.384,90	8.297,30	BBN2214760600060.	5.086,20	5.701,80	7.341,00
7	BBN2211760700060.	6.514,40	7.335,20	9.520,80	BBN2214760700060.	5.933,90	6.652,10	8.564,50
8	BBN2211760800060.	7.362,10	8.285,50	10.744,30	BBN2214760800060.	6.781,60	7.602,40	9.788,00
9	BBN2211760900060.	8.209,80	9.235,80	11.967,80	BBN2214760900060.	7.629,30	8.552,70	11.011,50
10	BBN2211761000060.	9.057,50	10.186,10	13.191,30	BBN2214761000060.	8.477,00	9.503,00	12.235,00
11	BBN2211761100060.	9.905,20	11.136,40	14.414,80				
12	BBN2211761200060.	10.752,90	12.086,70	15.638,30				
13	BBN2211761300060.	11.600,60	13.037,00	16.861,80				
14	BBN2211761400060.	12.448,30	13.987,30	18.085,30				
15	BBN2211761500060.	13.296,00	14.937,60	19.308,80				
16	BBN2211761600060.	14.143,70	15.887,90	20.532,30				
17	BBN2211761700060.	14.991,40	16.838,20	21.755,80				
18	BBN2211761800060.	15.839,10	17.788,50	22.979,30				

LINGO ROUND SHELVING SYSTEM

BBN221 - 18° - HIGH STEEL BACK PANEL - ADJUSTABLE FEET - FOR TOP SHELF



LINGO ROUND SHELVING SYSTEM

BBN221 - 18° - HIGH STEEL BACK PANEL - ADJUSTABLE FEET - FOR TOP SHELF

Round shelving system with wooden panels and high steel back panel.

To be used with top shelf WT5 standard depth top shelf.

Freestanding bay includes 2 wooden end panels and 1 high steel back panel.

Intermediate bay includes 1 intermediate wooden panel and 1 high steel back panel.

- Prices based on steel price group 1 and wooden price group A (see Design Options pages 6-9).

- For top shelves, see from page 340

- For shelves, see from page 328

- For castor frame, see page 347

- For end panel bay, see page 358

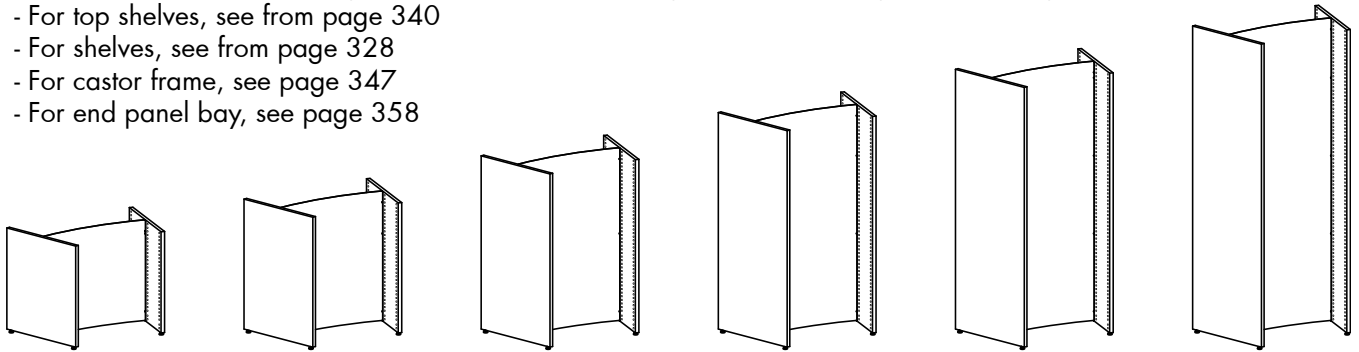

Double-sided freestanding bay - H720/920/1220/1520/1820/2120 mm

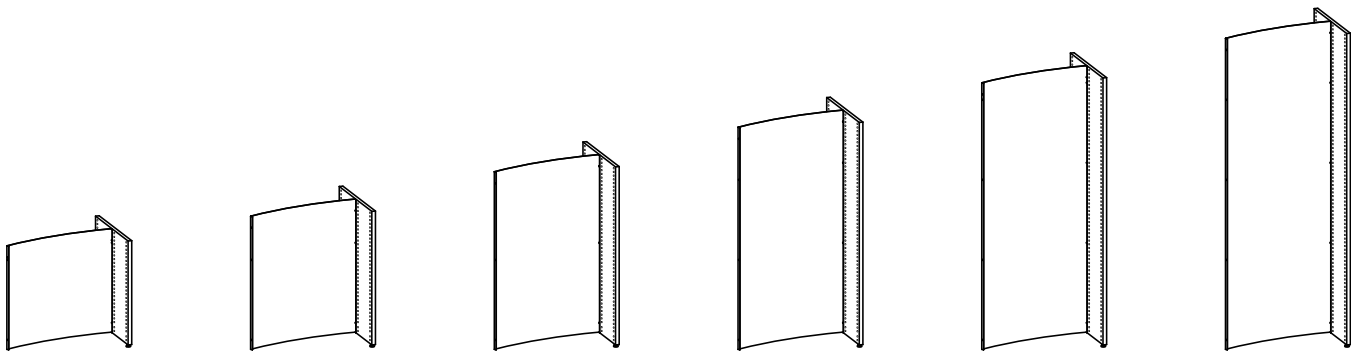

Double-sided intermediate bay - H720/920/1220/1520/1820/2120 mm

LINGO ROUND SHELVING SYSTEM

18° - HIGH STEEL BACK PANEL - ADJUSTABLE FEET - FOR TOP SHELF

Painted and veneered Lingo Shelving Systems are FSC-certified.

H720 mm

No. of bays	Item no. Freestanding bay	Melamine EUR	Painted EUR	Veneer EUR	Item no. Intermediate bay	Melamine EUR	Painted EUR	Veneer EUR
1	BBN2211260100070.	689,70	775,70	1.043,10	BBN2214260100070.	445,10	488,10	603,40
2	BBN2211260200070.	1.134,80	1.263,80	1.646,50	BBN2214260200070.	890,20	976,20	1.206,80
3	BBN2211260300070.	1.579,90	1.751,90	2.249,90	BBN2214260300070.	1.335,30	1.464,30	1.810,20
4	BBN2211260400070.	2.025,00	2.240,00	2.853,30	BBN2214260400070.	1.780,40	1.952,40	2.413,60
5	BBN2211260500070.	2.470,10	2.728,10	3.456,70	BBN2214260500070.	2.225,50	2.440,50	3.017,00
6	BBN2211260600070.	2.915,20	3.216,20	4.060,10	BBN2214260600070.	2.670,60	2.928,60	3.620,40
7	BBN2211260700070.	3.360,30	3.704,30	4.663,50	BBN2214260700070.	3.115,70	3.416,70	4.223,80
8	BBN2211260800070.	3.805,40	4.192,40	5.266,90	BBN2214260800070.	3.560,80	3.904,80	4.827,20
9	BBN2211260900070.	4.250,50	4.680,50	5.870,30	BBN2214260900070.	4.005,90	4.392,90	5.430,60
10	BBN2211261000070.	4.695,60	5.168,60	6.473,70	BBN2214261000070.	4.451,00	4.881,00	6.034,00
11	BBN2211261100070.	5.140,70	5.656,70	7.077,10				
12	BBN2211261200070.	5.585,80	6.144,80	7.680,50				
13	BBN2211261300070.	6.030,90	6.632,90	8.283,90				
14	BBN2211261400070.	6.476,00	7.121,00	8.887,30				
15	BBN2211261500070.	6.921,10	7.609,10	9.490,70				
16	BBN2211261600070.	7.366,20	8.097,20	10.094,10				
17	BBN2211261700070.	7.811,30	8.585,30	10.697,50				
18	BBN2211261800070.	8.256,40	9.073,40	11.300,90				

H920 mm

No. of bays	Item no. Freestanding bay	Melamine EUR	Painted EUR	Veneer EUR	Item no. Intermediate bay	Melamine EUR	Painted EUR	Veneer EUR
1	BBN2211360100070.	881,30	991,90	1.286,30	BBN2214360100070.	568,70	624,00	771,20
2	BBN2211360200070.	1.450,00	1.615,90	2.057,50	BBN2214360200070.	1.137,40	1.248,00	1.542,40
3	BBN2211360300070.	2.018,70	2.239,90	2.828,70	BBN2214360300070.	1.706,10	1.872,00	2.313,60
4	BBN2211360400070.	2.587,40	2.863,90	3.599,90	BBN2214360400070.	2.274,80	2.496,00	3.084,80
5	BBN2211360500070.	3.156,10	3.487,90	4.371,10	BBN2214360500070.	2.843,50	3.120,00	3.856,00
6	BBN2211360600070.	3.724,80	4.111,90	5.142,30	BBN2214360600070.	3.412,20	3.744,00	4.627,20
7	BBN2211360700070.	4.293,50	4.735,90	5.913,50	BBN2214360700070.	3.980,90	4.368,00	5.398,40
8	BBN2211360800070.	4.862,20	5.359,90	6.684,70	BBN2214360800070.	4.549,60	4.992,00	6.169,60
9	BBN2211360900070.	5.430,90	5.983,90	7.455,90	BBN2214360900070.	5.118,30	5.616,00	6.940,80
10	BBN2211361000070.	5.999,60	6.607,90	8.227,10	BBN2214361000070.	5.687,00	6.240,00	7.712,00
11	BBN2211361100070.	6.568,30	7.231,90	8.998,30				
12	BBN2211361200070.	7.137,00	7.855,90	9.769,50				
13	BBN2211361300070.	7.705,70	8.479,90	10.540,70				
14	BBN2211361400070.	8.274,40	9.103,90	11.311,90				
15	BBN2211361500070.	8.843,10	9.727,90	12.083,10				
16	BBN2211361600070.	9.411,80	10.351,90	12.854,30				
17	BBN2211361700070.	9.980,50	10.975,90	13.625,50				
18	BBN2211361800070.	10.549,20	11.599,90	14.396,70				

H1220 mm

No. of bays	Item no. Freestanding bay	Melamine EUR	Painted EUR	Veneer EUR	Item no. Intermediate bay	Melamine EUR	Painted EUR	Veneer EUR
1	BBN2211460100070.	1.152,10	1.295,30	1.678,50	BBN2214460100070.	745,90	817,50	1.009,10
2	BBN2211460200070.	1.898,00	2.112,80	2.687,60	BBN2214460200070.	1.491,80	1.635,00	2.018,20
3	BBN2211460300070.	2.643,90	2.930,30	3.696,70	BBN2214460300070.	2.237,70	2.452,50	3.027,30
4	BBN2211460400070.	3.389,80	3.747,80	4.705,80	BBN2214460400070.	2.983,60	3.270,00	4.036,40
5	BBN2211460500070.	4.135,70	4.565,30	5.714,90	BBN2214460500070.	3.729,50	4.087,50	5.045,50
6	BBN2211460600070.	4.881,60	5.382,80	6.724,00	BBN2214460600070.	4.475,40	4.905,00	6.054,60
7	BBN2211460700070.	5.627,50	6.200,30	7.733,10	BBN2214460700070.	5.221,30	5.722,50	7.063,70
8	BBN2211460800070.	6.373,40	7.017,80	8.742,20	BBN2214460800070.	5.967,20	6.540,00	8.072,80
9	BBN2211460900070.	7.119,30	7.835,30	9.751,30	BBN2214460900070.	6.713,10	7.357,50	9.081,90
10	BBN2211461000070.	7.865,20	8.652,80	10.760,40	BBN2214461000070.	7.459,00	8.175,00	10.091,00
11	BBN2211461100070.	8.611,10	9.470,30	11.769,50				
12	BBN2211461200070.	9.357,00	10.287,80	12.778,60				
13	BBN2211461300070.	10.102,90	11.105,30	13.787,70				
14	BBN2211461400070.	10.848,80	11.922,80	14.796,80				
15	BBN2211461500070.	11.594,70	12.740,30	15.805,90				
16	BBN2211461600070.	12.340,60	13.557,80	16.815,00				
17	BBN2211461700070.	13.086,50	14.375,30	17.824,10				
18	BBN2211461800070.	13.832,40	15.192,80	18.833,20				

LINGO ROUND SHELVING SYSTEM

18° - HIGH STEEL BACK PANEL - ADJUSTABLE FEET - FOR TOP SHELF

Painted and veneered Lingo Shelving Systems are FSC-certified.

H1520 mm

No. of bays	Item no. Freestanding bay	Melamine EUR	Painted EUR	Veneer EUR	Item no. Intermediate bay	Melamine EUR	Painted EUR	Veneer EUR
1	BBN2211560100070.	1.278,90	1.429,90	1.833,50	BBN2214560100070.	851,00	926,50	1.128,30
2	BBN2211560200070.	2.129,90	2.356,40	2.961,80	BBN2214560200070.	1.702,00	1.853,00	2.256,60
3	BBN2211560300070.	2.980,90	3.282,90	4.090,10	BBN2214560300070.	2.553,00	2.779,50	3.384,90
4	BBN2211560400070.	3.831,90	4.209,40	5.218,40	BBN2214560400070.	3.404,00	3.706,00	4.513,20
5	BBN2211560500070.	4.682,90	5.135,90	6.346,70	BBN2214560500070.	4.255,00	4.632,50	5.641,50
6	BBN2211560600070.	5.533,90	6.062,40	7.475,00	BBN2214560600070.	5.106,00	5.559,00	6.769,80
7	BBN2211560700070.	6.384,90	6.988,90	8.603,30	BBN2214560700070.	5.957,00	6.485,50	7.898,10
8	BBN2211560800070.	7.235,90	7.915,40	9.731,60	BBN2214560800070.	6.808,00	7.412,00	9.026,40
9	BBN2211560900070.	8.086,90	8.841,90	10.859,90	BBN2214560900070.	7.659,00	8.338,50	10.154,70
10	BBN2211561000070.	8.937,90	9.768,40	11.988,20	BBN2214561000070.	8.510,00	9.265,00	11.283,00
11	BBN2211561100070.	9.788,90	10.694,90	13.116,50				
12	BBN2211561200070.	10.639,90	11.621,40	14.244,80				
13	BBN2211561300070.	11.490,90	12.547,90	15.373,10				
14	BBN2211561400070.	12.341,90	13.474,40	16.501,40				
15	BBN2211561500070.	13.192,90	14.400,90	17.629,70				
16	BBN2211561600070.	14.043,90	15.327,40	18.758,00				
17	BBN2211561700070.	14.894,90	16.253,90	19.886,30				
18	BBN2211561800070.	15.745,90	17.180,40	21.014,60				

H1820 mm

No. of bays	Item no. Freestanding bay	Melamine EUR	Painted EUR	Veneer EUR	Item no. Intermediate bay	Melamine EUR	Painted EUR	Veneer EUR
1	BBN2211660100070.	1.517,60	1.696,60	2.172,20	BBN2214660100070.	1.012,10	1.101,60	1.339,40
2	BBN2211660200070.	2.529,70	2.798,20	3.511,60	BBN2214660200070.	2.024,20	2.203,20	2.678,80
3	BBN2211660300070.	3.541,80	3.899,80	4.851,00	BBN2214660300070.	3.036,30	3.304,80	4.018,20
4	BBN2211660400070.	4.553,90	5.001,40	6.190,40	BBN2214660400070.	4.048,40	4.406,40	5.357,60
5	BBN2211660500070.	5.566,00	6.103,00	7.529,80	BBN2214660500070.	5.060,50	5.508,00	6.697,00
6	BBN2211660600070.	6.578,10	7.204,60	8.869,20	BBN2214660600070.	6.072,60	6.609,60	8.036,40
7	BBN2211660700070.	7.590,20	8.306,20	10.208,60	BBN2214660700070.	7.084,70	7.711,20	9.375,80
8	BBN2211660800070.	8.602,30	9.407,80	11.548,00	BBN2214660800070.	8.096,80	8.812,80	10.715,20
9	BBN2211660900070.	9.614,40	10.509,40	12.887,40	BBN2214660900070.	9.108,90	9.914,40	12.054,60
10	BBN2211661000070.	10.626,50	11.611,00	14.226,80	BBN2214661000070.	10.121,00	11.016,00	13.394,00
11	BBN2211661100070.	11.638,60	12.712,60	15.566,20				
12	BBN2211661200070.	12.650,70	13.814,20	16.905,60				
13	BBN2211661300070.	13.662,80	14.915,80	18.245,00				
14	BBN2211661400070.	14.674,90	16.017,40	19.584,40				
15	BBN2211661500070.	15.687,00	17.119,00	20.923,80				
16	BBN2211661600070.	16.699,10	18.220,60	22.263,20				
17	BBN2211661700070.	17.711,20	19.322,20	23.602,60				
18	BBN2211661800070.	18.723,30	20.423,80	24.942,00				

H2120 mm

No. of bays	Item no. Freestanding bay	Melamine EUR	Painted EUR	Veneer EUR	Item no. Intermediate bay	Melamine EUR	Painted EUR	Veneer EUR
1	BBN2211760100070.	1.751,00	1.956,20	2.502,60	BBN2214760100070.	1.170,50	1.273,10	1.546,30
2	BBN2211760200070.	2.921,50	3.229,30	4.048,90	BBN2214760200070.	2.341,00	2.546,20	3.092,60
3	BBN2211760300070.	4.092,00	4.502,40	5.595,20	BBN2214760300070.	3.511,50	3.819,30	4.638,90
4	BBN2211760400070.	5.262,50	5.775,50	7.141,50	BBN2214760400070.	4.682,00	5.092,40	6.185,20
5	BBN2211760500070.	6.433,00	7.048,60	8.687,80	BBN2214760500070.	5.852,50	6.365,50	7.731,50
6	BBN2211760600070.	7.603,50	8.321,70	10.234,10	BBN2214760600070.	7.023,00	7.638,60	9.277,80
7	BBN2211760700070.	8.774,00	9.594,80	11.780,40	BBN2214760700070.	8.193,50	8.911,70	10.824,10
8	BBN2211760800070.	9.944,50	10.867,90	13.326,70	BBN2214760800070.	9.364,00	10.184,80	12.370,40
9	BBN2211760900070.	11.115,00	12.141,00	14.873,00	BBN2214760900070.	10.534,50	11.457,90	13.916,70
10	BBN2211761000070.	12.285,50	13.414,10	16.419,30	BBN2214761000070.	11.705,00	12.731,00	15.463,00
11	BBN2211761100070.	13.456,00	14.687,20	17.965,60				
12	BBN2211761200070.	14.626,50	15.960,30	19.511,90				
13	BBN2211761300070.	15.797,00	17.233,40	21.058,20				
14	BBN2211761400070.	16.967,50	18.506,50	22.604,50				
15	BBN2211761500070.	18.138,00	19.779,60	24.150,80				
16	BBN2211761600070.	19.308,50	21.052,70	25.697,10				
17	BBN2211761700070.	20.479,00	22.325,80	27.243,40				
18	BBN2211761800070.	21.649,50	23.598,90	28.789,70				

LINGO ROUND SHELVING SYSTEM

BBN221 - 18° - LOW STEEL BACK PANEL - ADJUSTABLE FEET - FOR TOP SHELF



LINGO ROUND SHELVING SYSTEM

BBN221 - 18° - LOW STEEL BACK PANEL - ADJUSTABLE FEET - FOR TOP SHELF

Round shelving system with wooden panels and low steel back panel.

To be used with top shelves WT5 full depth and WT5 double-sided top shelf.

Freestanding bay includes 2 end wooden panels and 1 low steel back panel.

Intermediate bay includes 1 intermediate wooden panel and 1 low steel back panel.

- Prices based on steel price group 1 and wooden price group A (see Design Options pages 6-9).

- For top shelves, see from page 340

- For shelves, see from page 328

- For plinths, see page 349

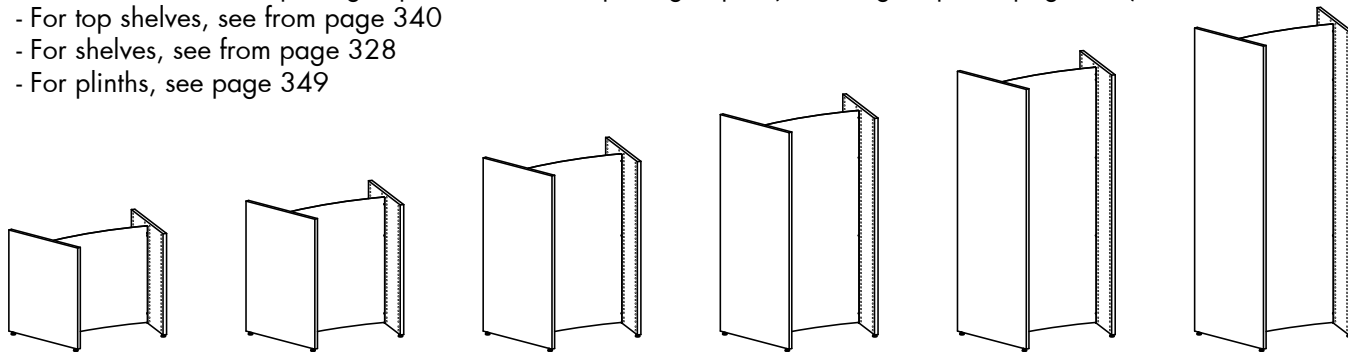

Double-sided freestanding bay - H720/920/1220/1520/1820/2120 mm

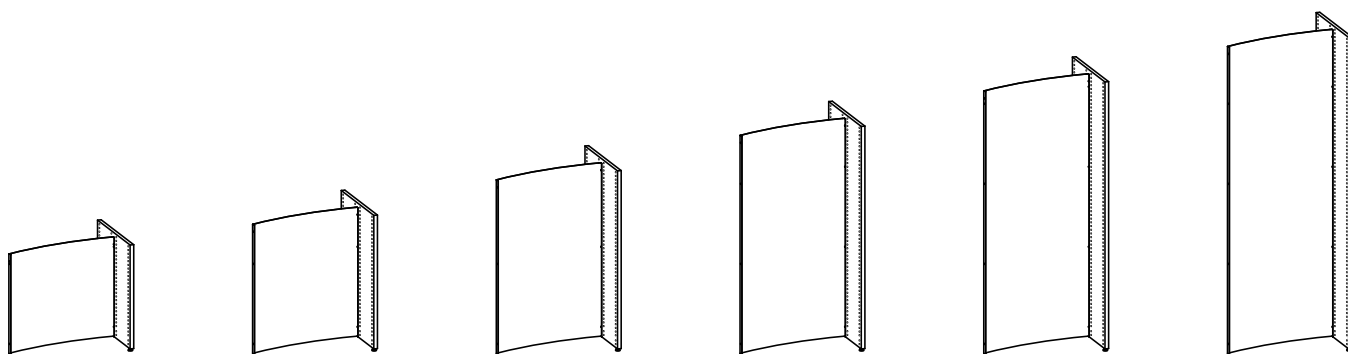

Double-sided intermediate bay - H720/920/1220/1520/1820/2120 mm

LINGO ROUND SHELVING SYSTEM

18° - LOW STEEL BACK PANEL - ADJUSTABLE FEET - FOR TOP SHELF

Painted and veneered Lingo Shelving Systems are FSC-certified.

H720 mm

No. of bays	Item no. Freestanding bay	Melamine EUR	Painted EUR	Veneer EUR	Item no. Intermediate bay	Melamine EUR	Painted EUR	Veneer EUR
1	BBN2211260100080.	689,70	775,70	1.043,10	BBN2214260100080.	445,10	488,10	603,40
2	BBN2211260200080.	1.134,80	1.263,80	1.646,50	BBN2214260200080.	890,20	976,20	1.206,80
3	BBN2211260300080.	1.579,90	1.751,90	2.249,90	BBN2214260300080.	1.335,30	1.464,30	1.810,20
4	BBN2211260400080.	2.025,00	2.240,00	2.853,30	BBN2214260400080.	1.780,40	1.952,40	2.413,60
5	BBN2211260500080.	2.470,10	2.728,10	3.456,70	BBN2214260500080.	2.225,50	2.440,50	3.017,00
6	BBN2211260600080.	2.915,20	3.216,20	4.060,10	BBN2214260600080.	2.670,60	2.928,60	3.620,40
7	BBN2211260700080.	3.360,30	3.704,30	4.663,50	BBN2214260700080.	3.115,70	3.416,70	4.223,80
8	BBN2211260800080.	3.805,40	4.192,40	5.266,90	BBN2214260800080.	3.560,80	3.904,80	4.827,20
9	BBN2211260900080.	4.250,50	4.680,50	5.870,30	BBN2214260900080.	4.005,90	4.392,90	5.430,60
10	BBN2211261000080.	4.695,60	5.168,60	6.473,70	BBN2214261000080.	4.451,00	4.881,00	6.034,00
11	BBN2211261100080.	5.140,70	5.656,70	7.077,10				
12	BBN2211261200080.	5.585,80	6.144,80	7.680,50				
13	BBN2211261300080.	6.030,90	6.632,90	8.283,90				
14	BBN2211261400080.	6.476,00	7.121,00	8.887,30				
15	BBN2211261500080.	6.921,10	7.609,10	9.490,70				
16	BBN2211261600080.	7.366,20	8.097,20	10.094,10				
17	BBN2211261700080.	7.811,30	8.585,30	10.697,50				
18	BBN2211261800080.	8.256,40	9.073,40	11.300,90				

H920 mm

No. of bays	Item no. Freestanding bay	Melamine EUR	Painted EUR	Veneer EUR	Item no. Intermediate bay	Melamine EUR	Painted EUR	Veneer EUR
1	BBN2211360100080.	881,30	991,90	1.286,30	BBN2214360100080.	568,70	624,00	771,20
2	BBN2211360200080.	1.450,00	1.615,90	2.057,50	BBN2214360200080.	1.137,40	1.248,00	1.542,40
3	BBN2211360300080.	2.018,70	2.239,90	2.828,70	BBN2214360300080.	1.706,10	1.872,00	2.313,60
4	BBN2211360400080.	2.587,40	2.863,90	3.599,90	BBN2214360400080.	2.274,80	2.496,00	3.084,80
5	BBN2211360500080.	3.156,10	3.487,90	4.371,10	BBN2214360500080.	2.843,50	3.120,00	3.856,00
6	BBN2211360600080.	3.724,80	4.111,90	5.142,30	BBN2214360600080.	3.412,20	3.744,00	4.627,20
7	BBN2211360700080.	4.293,50	4.735,90	5.913,50	BBN2214360700080.	3.980,90	4.368,00	5.398,40
8	BBN2211360800080.	4.862,20	5.359,90	6.684,70	BBN2214360800080.	4.549,60	4.992,00	6.169,60
9	BBN2211360900080.	5.430,90	5.983,90	7.455,90	BBN2214360900080.	5.118,30	5.616,00	6.940,80
10	BBN2211361000080.	5.999,60	6.607,90	8.227,10	BBN2214361000080.	5.687,00	6.240,00	7.712,00
11	BBN2211361100080.	6.568,30	7.231,90	8.998,30				
12	BBN2211361200080.	7.137,00	7.855,90	9.769,50				
13	BBN2211361300080.	7.705,70	8.479,90	10.540,70				
14	BBN2211361400080.	8.274,40	9.103,90	11.311,90				
15	BBN2211361500080.	8.843,10	9.727,90	12.083,10				
16	BBN2211361600080.	9.411,80	10.351,90	12.854,30				
17	BBN2211361700080.	9.980,50	10.975,90	13.625,50				
18	BBN2211361800080.	10.549,20	11.599,90	14.396,70				

H1220 mm

No. of bays	Item no. Freestanding bay	Melamine EUR	Painted EUR	Veneer EUR	Item no. Intermediate bay	Melamine EUR	Painted EUR	Veneer EUR
1	BBN2211460100080.	1.152,10	1.295,30	1.678,50	BBN2214460100080.	745,90	817,50	1.009,10
2	BBN2211460200080.	1.898,00	2.112,80	2.687,60	BBN2214460200080.	1.491,80	1.635,00	2.018,20
3	BBN2211460300080.	2.643,90	2.930,30	3.696,70	BBN2214460300080.	2.237,70	2.452,50	3.027,30
4	BBN2211460400080.	3.389,80	3.747,80	4.705,80	BBN2214460400080.	2.983,60	3.270,00	4.036,40
5	BBN2211460500080.	4.135,70	4.565,30	5.714,90	BBN2214460500080.	3.729,50	4.087,50	5.045,50
6	BBN2211460600080.	4.881,60	5.382,80	6.724,00	BBN2214460600080.	4.475,40	4.905,00	6.054,60
7	BBN2211460700080.	5.627,50	6.200,30	7.733,10	BBN2214460700080.	5.221,30	5.722,50	7.063,70
8	BBN2211460800080.	6.373,40	7.017,80	8.742,20	BBN2214460800080.	5.967,20	6.540,00	8.072,80
9	BBN2211460900080.	7.119,30	7.835,30	9.751,30	BBN2214460900080.	6.713,10	7.357,50	9.081,90
10	BBN2211461000080.	7.865,20	8.652,80	10.760,40	BBN2214461000080.	7.459,00	8.175,00	10.091,00
11	BBN2211461100080.	8.611,10	9.470,30	11.769,50				
12	BBN2211461200080.	9.357,00	10.287,80	12.778,60				
13	BBN2211461300080.	10.102,90	11.105,30	13.787,70				
14	BBN2211461400080.	10.848,80	11.922,80	14.796,80				
15	BBN2211461500080.	11.594,70	12.740,30	15.805,90				
16	BBN2211461600080.	12.340,60	13.557,80	16.815,00				
17	BBN2211461700080.	13.086,50	14.375,30	17.824,10				
18	BBN2211461800080.	13.832,40	15.192,80	18.833,20				

LINGO ROUND SHELVING SYSTEM

18° - LOW STEEL BACK PANEL - ADJUSTABLE FEET - FOR TOP SHELF

Painted and veneered Lingo Shelving Systems are FSC-certified.

H1520 mm

No. of bays	Item no. Freestanding bay	Melamine EUR	Painted EUR	Veneer EUR	Item no. Intermediate bay	Melamine EUR	Painted EUR	Veneer EUR
1	BBN2211560100080.	1.278,90	1.429,90	1.833,50	BBN2214560100080.	851,00	926,50	1.128,30
2	BBN2211560200080.	2.129,90	2.356,40	2.961,80	BBN2214560200080.	1.702,00	1.853,00	2.256,60
3	BBN2211560300080.	2.980,90	3.282,90	4.090,10	BBN2214560300080.	2.553,00	2.779,50	3.384,90
4	BBN2211560400080.	3.831,90	4.209,40	5.218,40	BBN2214560400080.	3.404,00	3.706,00	4.513,20
5	BBN2211560500080.	4.682,90	5.135,90	6.346,70	BBN2214560500080.	4.255,00	4.632,50	5.641,50
6	BBN2211560600080.	5.533,90	6.062,40	7.475,00	BBN2214560600080.	5.106,00	5.559,00	6.769,80
7	BBN2211560700080.	6.384,90	6.988,90	8.603,30	BBN2214560700080.	5.957,00	6.485,50	7.898,10
8	BBN2211560800080.	7.235,90	7.915,40	9.731,60	BBN2214560800080.	6.808,00	7.412,00	9.026,40
9	BBN2211560900080.	8.086,90	8.841,90	10.859,90	BBN2214560900080.	7.659,00	8.338,50	10.154,70
10	BBN2211561000080.	8.937,90	9.768,40	11.988,20	BBN2214561000080.	8.510,00	9.265,00	11.283,00
11	BBN2211561100080.	9.788,90	10.694,90	13.116,50				
12	BBN2211561200080.	10.639,90	11.621,40	14.244,80				
13	BBN2211561300080.	11.490,90	12.547,90	15.373,10				
14	BBN2211561400080.	12.341,90	13.474,40	16.501,40				
15	BBN2211561500080.	13.192,90	14.400,90	17.629,70				
16	BBN2211561600080.	14.043,90	15.327,40	18.758,00				
17	BBN2211561700080.	14.894,90	16.253,90	19.886,30				
18	BBN2211561800080.	15.745,90	17.180,40	21.014,60				

H1820 mm

No. of bays	Item no. Freestanding bay	Melamine EUR	Painted EUR	Veneer EUR	Item no. Intermediate bay	Melamine EUR	Painted EUR	Veneer EUR
1	BBN2211660100080.	1.517,60	1.696,60	2.172,20	BBN2214660100080.	1.012,10	1.101,60	1.339,40
2	BBN2211660200080.	2.529,70	2.798,20	3.511,60	BBN2214660200080.	2.024,20	2.203,20	2.678,80
3	BBN2211660300080.	3.541,80	3.899,80	4.851,00	BBN2214660300080.	3.036,30	3.304,80	4.018,20
4	BBN2211660400080.	4.553,90	5.001,40	6.190,40	BBN2214660400080.	4.048,40	4.406,40	5.357,60
5	BBN2211660500080.	5.566,00	6.103,00	7.529,80	BBN2214660500080.	5.060,50	5.508,00	6.697,00
6	BBN2211660600080.	6.578,10	7.204,60	8.869,20	BBN2214660600080.	6.072,60	6.609,60	8.036,40
7	BBN2211660700080.	7.590,20	8.306,20	10.208,60	BBN2214660700080.	7.084,70	7.711,20	9.375,80
8	BBN2211660800080.	8.602,30	9.407,80	11.548,00	BBN2214660800080.	8.096,80	8.812,80	10.715,20
9	BBN2211660900080.	9.614,40	10.509,40	12.887,40	BBN2214660900080.	9.108,90	9.914,40	12.054,60
10	BBN2211661000080.	10.626,50	11.611,00	14.226,80	BBN2214661000080.	10.121,00	11.016,00	13.394,00
11	BBN2211661100080.	11.638,60	12.712,60	15.566,20				
12	BBN2211661200080.	12.650,70	13.814,20	16.905,60				
13	BBN2211661300080.	13.662,80	14.915,80	18.245,00				
14	BBN2211661400080.	14.674,90	16.017,40	19.584,40				
15	BBN2211661500080.	15.687,00	17.119,00	20.923,80				
16	BBN2211661600080.	16.699,10	18.220,60	22.263,20				
17	BBN2211661700080.	17.711,20	19.322,20	23.602,60				
18	BBN2211661800080.	18.723,30	20.423,80	24.942,00				

H2120 mm

No. of bays	Item no. Freestanding bay	Melamine EUR	Painted EUR	Veneer EUR	Item no. Intermediate bay	Melamine EUR	Painted EUR	Veneer EUR
1	BBN2211760100080.	1.751,00	1.956,20	2.502,60	BBN2214760100080.	1.170,50	1.273,10	1.546,30
2	BBN2211760200080.	2.921,50	3.229,30	4.048,90	BBN2214760200080.	2.341,00	2.546,20	3.092,60
3	BBN2211760300080.	4.092,00	4.502,40	5.595,20	BBN2214760300080.	3.511,50	3.819,30	4.638,90
4	BBN2211760400080.	5.262,50	5.775,50	7.141,50	BBN2214760400080.	4.682,00	5.092,40	6.185,20
5	BBN2211760500080.	6.433,00	7.048,60	8.687,80	BBN2214760500080.	5.852,50	6.365,50	7.731,50
6	BBN2211760600080.	7.603,50	8.321,70	10.234,10	BBN2214760600080.	7.023,00	7.638,60	9.277,80
7	BBN2211760700080.	8.774,00	9.594,80	11.780,40	BBN2214760700080.	8.193,50	8.911,70	10.824,10
8	BBN2211760800080.	9.944,50	10.867,90	13.326,70	BBN2214760800080.	9.364,00	10.184,80	12.370,40
9	BBN2211760900080.	11.115,00	12.141,00	14.873,00	BBN2214760900080.	10.534,50	11.457,90	13.916,70
10	BBN2211761000080.	12.285,50	13.414,10	16.419,30	BBN2214761000080.	11.705,00	12.731,00	15.463,00
11	BBN2211761100080.	13.456,00	14.687,20	17.965,60				
12	BBN2211761200080.	14.626,50	15.960,30	19.511,90				
13	BBN2211761300080.	15.797,00	17.233,40	21.058,20				
14	BBN2211761400080.	16.967,50	18.506,50	22.604,50				
15	BBN2211761500080.	18.138,00	19.779,60	24.150,80				
16	BBN2211761600080.	19.308,50	21.052,70	25.697,10				
17	BBN2211761700080.	20.479,00	22.325,80	27.243,40				
18	BBN2211761800080.	21.649,50	23.598,90	28.789,70				

LINGO ROUND SHELVING SYSTEM

BBN222 - 18° - STEEL BACK FRAME - ADJUSTABLE FEET - WITH TOP PLATE



LINGO ROUND SHELVING SYSTEM

BBN222 - 18° - STEEL BACK FRAME - ADJUSTABLE FEET - WITH TOP PLATE

Round shelving system with wooden end panels, intermediate panels, steel back frame and overlaying top plate.
See further description on starter, intermediate and end sections on pages 26-27.

- Prices based on steel price group 1 and wooden price group A (see Design Options pages 6-9).
- For shelves, see from page 328
- For end panel bays, see page 378
- For plinths, see page 349

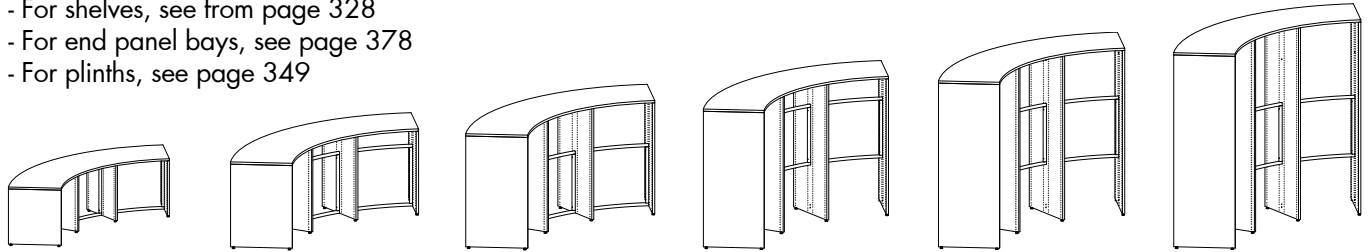

Freestanding 26° double-sided bays - H720/920/1220/1520/1820/2120 mm

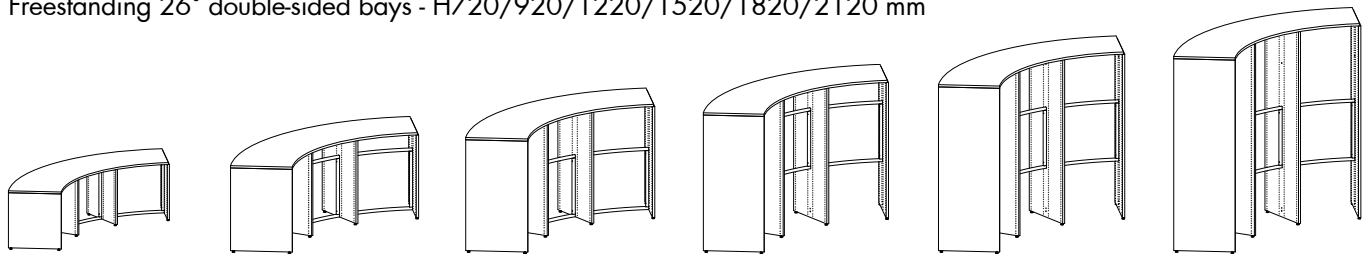

Left starter 26° double-sided bays - H720/920/1220/1520/1820/2120 mm

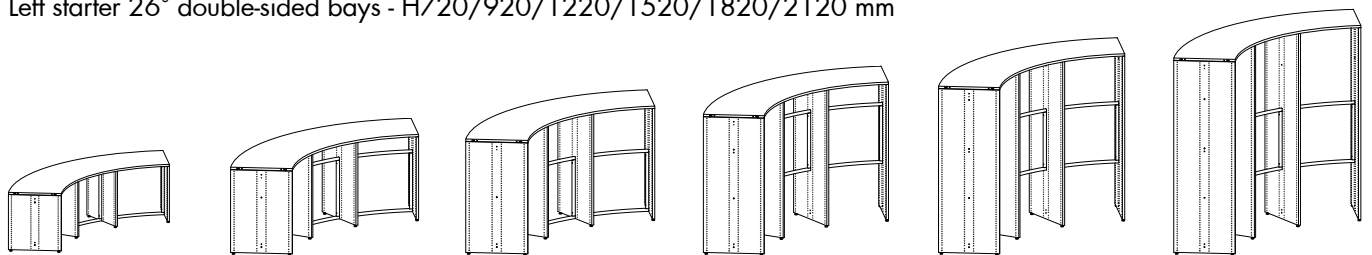

Right starter 26° double-sided bays - H720/920/1220/1520/1820/2120 mm

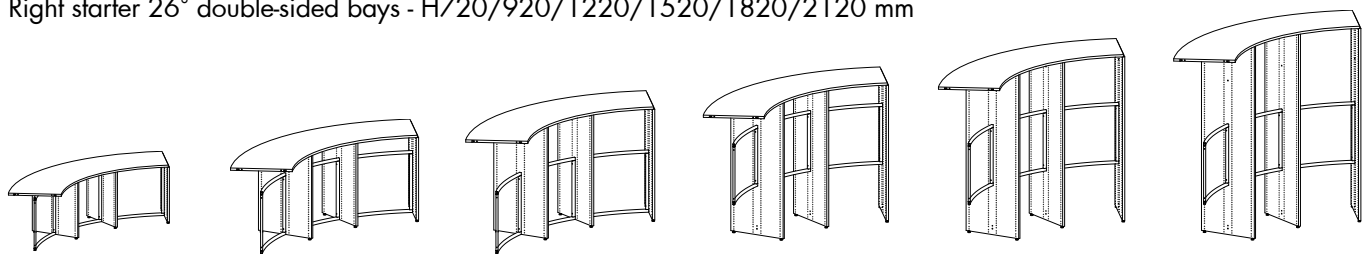

Intermediate 26° double-sided bays - H720/920/1220/1520/1820/2120 mm

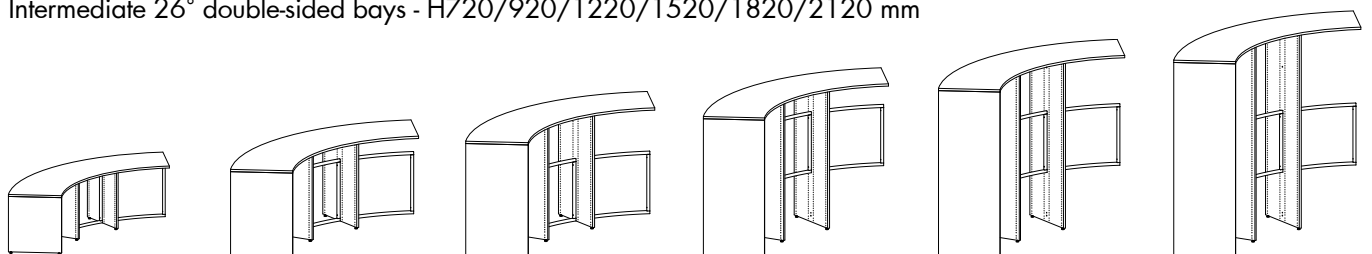

Left end 26° double-sided bays - H720/920/1220/1520/1820/2120 mm

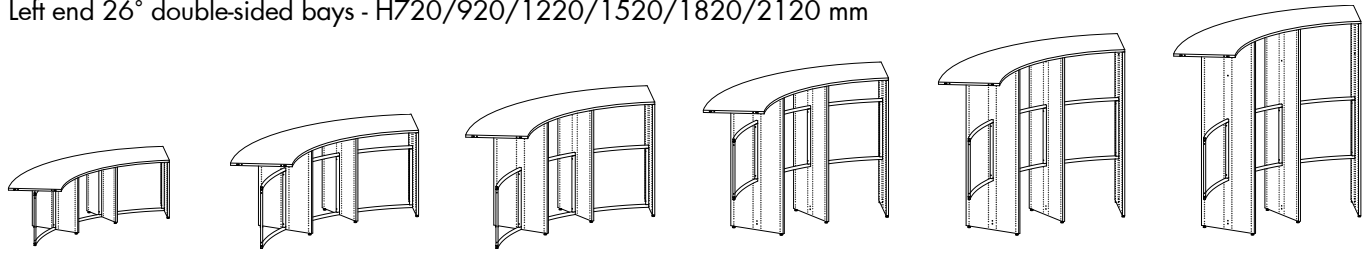

Right end 26° double-sided bays - H720/920/1220/1520/1820/2120 mm

LINGO ROUND SHELVING SYSTEM

18° - STEEL BACK FRAME - ADJUSTABLE FEET - WITH TOP PLATE - FREESTANDING SECTION

Painted and veneered Lingo Shelving Systems are FSC-certified.

H720 mm

No. of bays	Item no.	Melamine EUR	Painted EUR	Veneer EUR
1	BBN2221260110060.	1.530,20	1.752,60	2.347,60
2	BBN2221260210060.	2.845,50	3.252,90	4.341,00
3	BBN2221260310060.	4.094,70	4.675,10	6.225,50

H920 mm

No. of bays	Item no.	Melamine EUR	Painted EUR	Veneer EUR
1	BBN2221360110060.	1.666,20	1.913,20	2.572,00
2	BBN2221360210060.	3.049,50	3.493,80	4.677,60
3	BBN2221360310060.	4.366,70	4.996,30	6.674,30

H1220 mm

No. of bays	Item no.	Melamine EUR	Painted EUR	Veneer EUR
1	BBN2221460110060.	1.853,40	2.133,00	2.880,60
2	BBN2221460210060.	3.330,30	3.823,50	5.140,50
3	BBN2221460310060.	4.741,10	5.435,90	7.291,50

H1520 mm

No. of bays	Item no.	Melamine EUR	Painted EUR	Veneer EUR
1	BBN2221560110060.	1.896,80	2.184,20	2.952,20
2	BBN2221560210060.	3.395,40	3.900,30	5.247,90
3	BBN2221560310060.	4.827,90	5.538,30	7.434,70

H1820 mm

No. of bays	Item no.	Melamine EUR	Painted EUR	Veneer EUR
1	BBN2221660110060.	2.052,00	2.367,40	3.207,40
2	BBN2221660210060.	3.628,20	4.175,10	5.630,70
3	BBN2221660310060.	5.138,30	5.904,70	7.945,10

H2120 mm

No. of bays	Item no.	Melamine EUR	Painted EUR	Veneer EUR
1	BBN2221760110060.	2.202,00	2.543,60	3.454,40
2	BBN2221760210060.	3.853,20	4.439,40	6.001,20
3	BBN2221760310060.	5.438,30	6.257,10	8.439,10

LINGO ROUND SHELVING SYSTEM

18° - STEEL BACK FRAME - ADJUSTABLE FEET - WITH TOP PLATE - LEFT STARTER SECTION

Painted and veneered Lingo Shelving Systems are FSC-certified.

H720 mm

No. of bays	Item no.	Melamine EUR	Painted EUR	Veneer EUR
1	BBN2222260110060.	1.527,80	1.749,80	2.343,30
2	BBN2222260210060.	2.843,90	3.250,80	4.338,20
3	BBN2222260310060.	4.093,60	4.673,90	6.223,90

H920 mm

No. of bays	Item no.	Melamine EUR	Painted EUR	Veneer EUR
1	BBN2222360110060.	1.663,80	1.910,40	2.567,70
2	BBN2222360210060.	3.047,90	3.491,70	4.674,80
3	BBN2222360310060.	4.365,60	4.995,10	6.672,70

H1220 mm

No. of bays	Item no.	Melamine EUR	Painted EUR	Veneer EUR
1	BBN2222460110060.	1.851,00	2.130,20	2.876,30
2	BBN2222460210060.	3.328,70	3.821,40	5.137,70
3	BBN2222460310060.	4.740,00	5.434,70	7.289,90

H1520 mm

No. of bays	Item no.	Melamine EUR	Painted EUR	Veneer EUR
1	BBN2222560110060.	1.894,40	2.181,40	2.947,90
2	BBN2222560210060.	3.393,80	3.898,20	5.245,10
3	BBN2222560310060.	4.826,80	5.537,10	7.433,10

H1820 mm

No. of bays	Item no.	Melamine EUR	Painted EUR	Veneer EUR
1	BBN2222660110060.	2.049,60	2.364,60	3.203,10
2	BBN2222660210060.	3.626,60	4.173,00	5.627,90
3	BBN2222660310060.	5.137,20	5.903,50	7.943,50

H2120 mm

No. of bays	Item no.	Melamine EUR	Painted EUR	Veneer EUR
1	BBN2222760110060.	2.199,60	2.540,80	3.450,10
2	BBN2222760210060.	3.851,60	4.437,30	5.998,40
3	BBN2222760310060.	5.437,20	6.255,90	8.437,50

LINGO ROUND SHELVING SYSTEM

18° - STEEL BACK FRAME - ADJUSTABLE FEET - WITH TOP PLATE - RIGHT STARTER SECTION

Painted and veneered Lingo Shelving Systems are FSC-certified.

H720 mm

No. of bays	Item no.	Melamine EUR	Painted EUR	Veneer EUR
1	BBN2223260110060.	1.527,80	1.749,80	2.343,30
2	BBN2223260210060.	2.843,90	3.250,80	4.338,20
3	BBN2223260310060.	4.093,60	4.673,90	6.223,90

H920 mm

No. of bays	Item no.	Melamine EUR	Painted EUR	Veneer EUR
1	BBN2223360110060.	1.663,80	1.910,40	2.567,70
2	BBN2223360210060.	3.047,90	3.491,70	4.674,80
3	BBN2223360310060.	4.365,60	4.995,10	6.672,70

H1220 mm

No. of bays	Item no.	Melamine EUR	Painted EUR	Veneer EUR
1	BBN2223460110060.	1.851,00	2.130,20	2.876,30
2	BBN2223460210060.	3.328,70	3.821,40	5.137,70
3	BBN2223460310060.	4.740,00	5.434,70	7.289,90

H1520 mm

No. of bays	Item no.	Melamine EUR	Painted EUR	Veneer EUR
1	BBN2223560110060.	1.894,40	2.181,40	2.947,90
2	BBN2223560210060.	3.393,80	3.898,20	5.245,10
3	BBN2223560310060.	4.826,80	5.537,10	7.433,10

H1820 mm

No. of bays	Item no.	Melamine EUR	Painted EUR	Veneer EUR
1	BBN2223660110060.	2.049,60	2.364,60	3.203,10
2	BBN2223660210060.	3.626,60	4.173,00	5.627,90
3	BBN2223660310060.	5.137,20	5.903,50	7.943,50

H2120 mm

No. of bays	Item no.	Melamine EUR	Painted EUR	Veneer EUR
1	BBN2223760110060.	2.199,60	2.540,80	3.450,10
2	BBN2223760210060.	3.851,60	4.437,30	5.998,40
3	BBN2223760310060.	5.437,20	6.255,90	8.437,50

LINGO ROUND SHELVING SYSTEM

18° - STEEL BACK FRAME - ADJUSTABLE FEET - WITH TOP PLATE - INTERMEDIATE SECTION

Painted and veneered Lingo Shelving Systems are FSC-certified.

H720 mm

No. of bays	Item no.	Melamine EUR	Painted EUR	Veneer EUR
1	BBN2224260110060.	1.276,20	1.454,00	1.928,90
2	BBN2224260210060.	2.569,80	2.928,80	3.887,10
3	BBN2224260310060.	3.829,60	4.363,50	5.789,20

H920 mm

No. of bays	Item no.	Melamine EUR	Painted EUR	Veneer EUR
1	BBN2224360110060.	1.344,20	1.534,30	2.041,10
2	BBN2224360210060.	2.705,80	3.089,40	4.111,50
3	BBN2224360310060.	4.033,60	4.604,40	6.125,80

H1220 mm

No. of bays	Item no.	Melamine EUR	Painted EUR	Veneer EUR
1	BBN2224460110060.	1.437,80	1.644,20	2.195,40
2	BBN2224460210060.	2.893,00	3.309,20	4.420,10
3	BBN2224460310060.	4.314,40	4.934,10	6.588,70

H1520 mm

No. of bays	Item no.	Melamine EUR	Painted EUR	Veneer EUR
1	BBN2224560110060.	1.459,50	1.669,80	2.231,20
2	BBN2224560210060.	2.936,40	3.360,40	4.491,70
3	BBN2224560310060.	4.379,50	5.010,90	6.696,10

H1820 mm

No. of bays	Item no.	Melamine EUR	Painted EUR	Veneer EUR
1	BBN2224660110060.	1.537,10	1.761,40	2.358,80
2	BBN2224660210060.	3.091,60	3.543,60	4.746,90
3	BBN2224660310060.	4.612,30	5.285,70	7.078,90

H2120 mm

No. of bays	Item no.	Melamine EUR	Painted EUR	Veneer EUR
1	BBN2224760110060.	1.612,10	1.849,50	2.482,30
2	BBN2224760210060.	3.241,60	3.719,80	4.993,90
3	BBN2224760310060.	4.837,30	5.550,00	7.449,40

LINGO ROUND SHELVING SYSTEM

18° - STEEL BACK FRAME - ADJUSTABLE FEET - WITH TOP PLATE - LEFT END SECTION

Painted and veneered Lingo Shelving Systems are FSC-certified.

H720 mm

No. of bays	Item no.	Melamine EUR	Painted EUR	Veneer EUR
1	BBN2225260110060.	1.283,20	1.462,20	1.940,40
2	BBN2225260210060.	2.599,30	2.963,20	3.935,30
3	BBN2225260310060.	3.849,00	4.386,30	5.821,00

H920 mm

No. of bays	Item no.	Melamine EUR	Painted EUR	Veneer EUR
1	BBN2225360110060.	1.351,20	1.542,50	2.052,60
2	BBN2225360210060.	2.735,30	3.123,80	4.159,70
3	BBN2225360310060.	4.053,00	4.627,20	6.157,60

H1220 mm

No. of bays	Item no.	Melamine EUR	Painted EUR	Veneer EUR
1	BBN2225460110060.	1.444,80	1.652,40	2.206,90
2	BBN2225460210060.	2.922,50	3.343,60	4.468,30
3	BBN2225460310060.	4.333,80	4.956,90	6.620,50

H1520 mm

No. of bays	Item no.	Melamine EUR	Painted EUR	Veneer EUR
1	BBN2225560110060.	1.466,50	1.678,00	2.242,70
2	BBN2225560210060.	2.965,90	3.394,80	4.539,90
3	BBN2225560310060.	4.398,90	5.033,70	6.727,90

H1820 mm

No. of bays	Item no.	Melamine EUR	Painted EUR	Veneer EUR
1	BBN2225660110060.	1.544,10	1.769,60	2.370,30
2	BBN2225660210060.	3.121,10	3.578,00	4.795,10
3	BBN2225660310060.	4.631,70	5.308,50	7.110,70

H2120 mm

No. of bays	Item no.	Melamine EUR	Painted EUR	Veneer EUR
1	BBN2225760110060.	1.619,10	1.857,70	2.493,80
2	BBN2225760210060.	3.271,10	3.754,20	5.042,10
3	BBN2225760310060.	4.856,70	5.572,80	7.481,20

LINGO ROUND SHELVING SYSTEM

18° - STEEL BACK FRAME - ADJUSTABLE FEET - WITH TOP PLATE - RIGHT END SECTION

Painted and veneered Lingo Shelving Systems are FSC-certified.

H720 mm

No. of bays	Item no.	Melamine EUR	Painted EUR	Veneer EUR
1	BBN2226260110060.	1.283,20	1.462,20	1.940,40
2	BBN2226260210060.	2.599,30	2.963,20	3.935,30
3	BBN2226260310060.	3.849,00	4.386,30	5.821,00

H920 mm

No. of bays	Item no.	Melamine EUR	Painted EUR	Veneer EUR
1	BBN2226360110060.	1.351,20	1.542,50	2.052,60
2	BBN2226360210060.	2.735,30	3.123,80	4.159,70
3	BBN2226360310060.	4.053,00	4.627,20	6.157,60

H1220 mm

No. of bays	Item no.	Melamine EUR	Painted EUR	Veneer EUR
1	BBN2226460110060.	1.444,80	1.652,40	2.206,90
2	BBN2226460210060.	2.922,50	3.343,60	4.468,30
3	BBN2226460310060.	4.333,80	4.956,90	6.620,50

H1520 mm

No. of bays	Item no.	Melamine EUR	Painted EUR	Veneer EUR
1	BBN2226560110060.	1.466,50	1.678,00	2.242,70
2	BBN2226560210060.	2.965,90	3.394,80	4.539,90
3	BBN2226560310060.	4.398,90	5.033,70	6.727,90

H1820 mm

No. of bays	Item no.	Melamine EUR	Painted EUR	Veneer EUR
1	BBN2226660110060.	1.544,10	1.769,60	2.370,30
2	BBN2226660210060.	3.121,10	3.578,00	4.795,10
3	BBN2226660310060.	4.631,70	5.308,50	7.110,70

H2120 mm

No. of bays	Item no.	Melamine EUR	Painted EUR	Veneer EUR
1	BBN2226760110060.	1.619,10	1.857,70	2.493,80
2	BBN2226760210060.	3.271,10	3.754,20	5.042,10
3	BBN2226760310060.	4.856,70	5.572,80	7.481,20

LINGO ROUND SHELVING SYSTEM

BBN222 - 18° - STEEL BACK PANEL - ADJUSTABLE FEET - WITH TOP PLATE



LINGO ROUND SHELVING SYSTEM

BBN222 - 18° - STEEL BACK PANEL - ADJUSTABLE FEET - WITH TOP PLATE

Round shelving system with wooden end panels, intermediate panels, steel back panel and overlaying top plate.
See further description on starter, intermediate and end sections on pages 26-27.

- Prices based on steel price group 1 and wooden price group A (see Design Options pages 6-9).
- For shelves, see from page 328
- For castor frame, see page 347

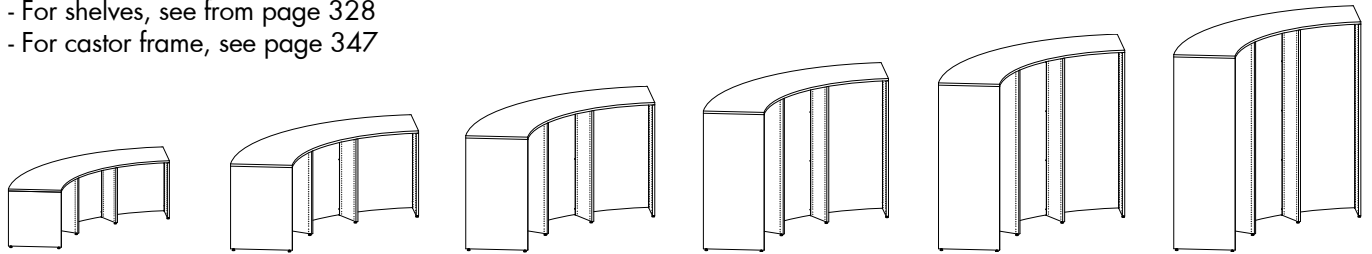

Freestanding 26° double-sided bays - H720/920/1220/1520/1820/2120 mm

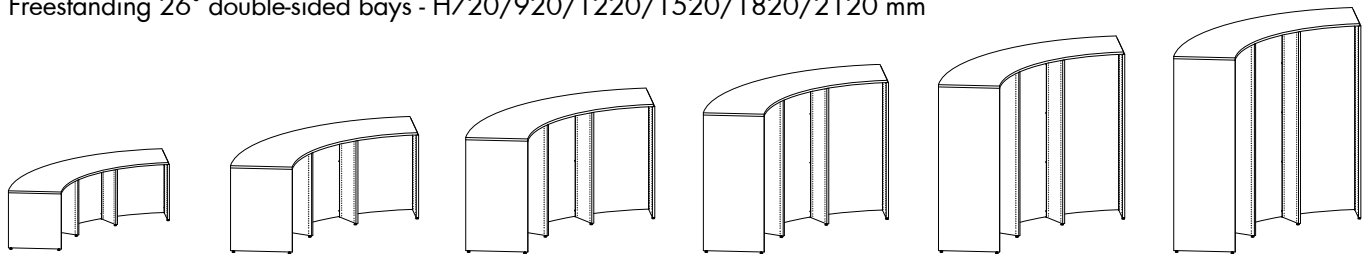

Left starter 26° double-sided bays - H720/920/1220/1520/1820/2120 mm

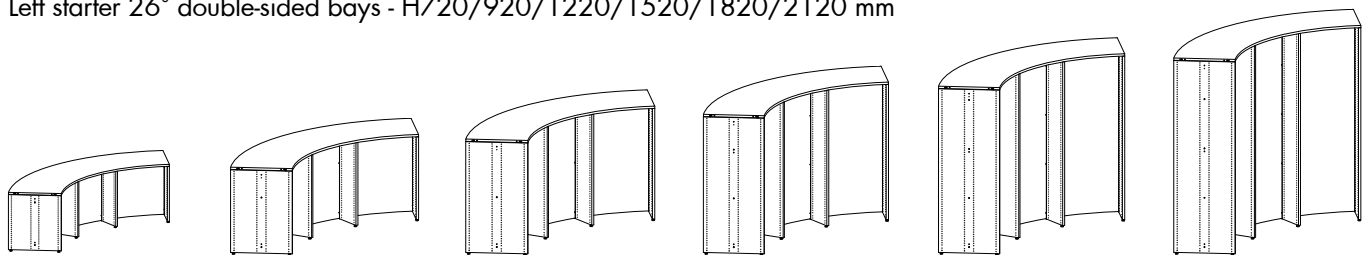

Right starter 26° double-sided bays - H720/920/1220/1520/1820/2120 mm

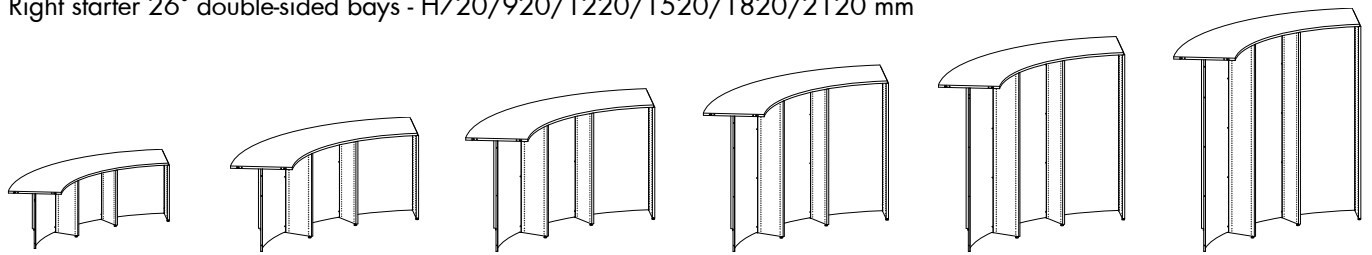

Intermediate 18° double-sided bays - H720/920/1220/1520/1820/2120 mm

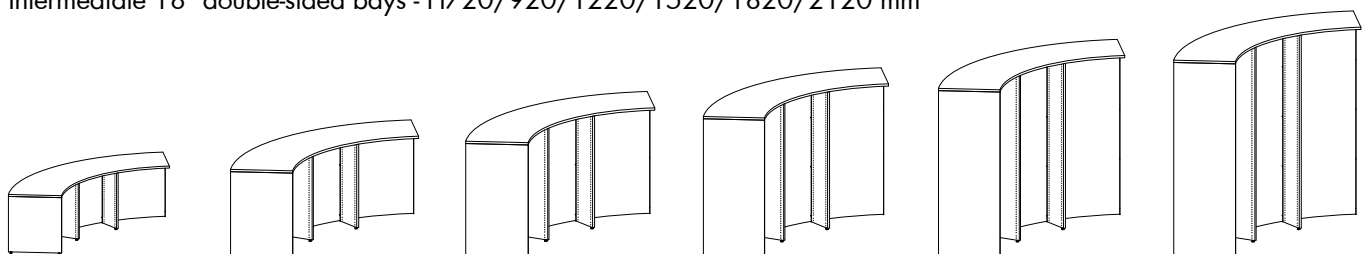

Left end 26° double-sided bays - H720/920/1220/1520/1820/2120 mm

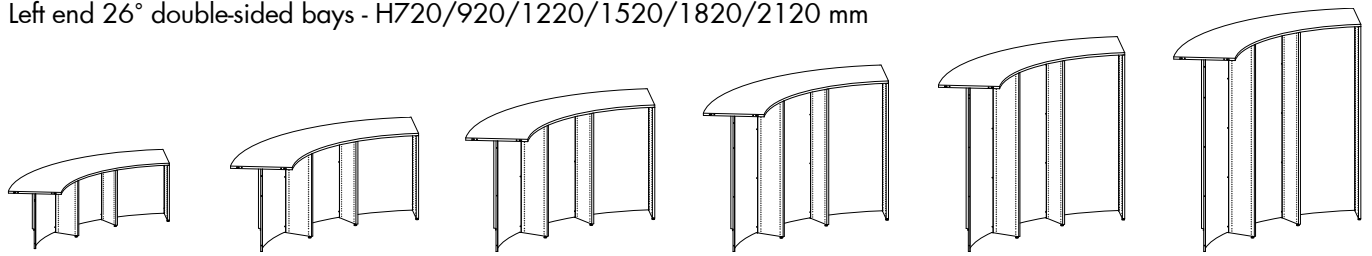

Right end 26° double-sided bays - H720/920/1220/1520/1820/2120 mm

LINGO ROUND SHELVING SYSTEM

18° - STEEL BACK PANEL - ADJUSTABLE FEET - WITH TOP PLATE - FREESTANDING SECTION

Painted and veneered Lingo Shelving Systems are FSC-certified.

H720 mm

No. of bays	Item no.	Melamine EUR	Painted EUR	Veneer EUR
1	BBN2221260110080.	1.463,50	1.685,90	2.280,90
2	BBN2221260210080.	2.712,10	3.119,50	4.207,60
3	BBN2221260310080.	3.894,60	4.475,00	6.025,40

H920 mm

No. of bays	Item no.	Melamine EUR	Painted EUR	Veneer EUR
1	BBN2221360110080.	1.655,10	1.902,10	2.560,90
2	BBN2221360210080.	3.027,30	3.471,60	4.655,40
3	BBN2221360310080.	4.333,40	4.963,00	6.641,00

H1220 mm

No. of bays	Item no.	Melamine EUR	Painted EUR	Veneer EUR
1	BBN2221460110080.	1.925,90	2.205,50	2.953,10
2	BBN2221460210080.	3.475,30	3.968,50	5.285,50
3	BBN2221460310080.	4.958,60	5.653,40	7.509,00

H1520 mm

No. of bays	Item no.	Melamine EUR	Painted EUR	Veneer EUR
1	BBN2221560110080.	2.052,70	2.340,10	3.108,10
2	BBN2221560210080.	3.707,20	4.212,10	5.559,70
3	BBN2221560310080.	5.295,60	6.006,00	7.902,40

H1820 mm

No. of bays	Item no.	Melamine EUR	Painted EUR	Veneer EUR
1	BBN2221660110080.	2.291,40	2.606,80	3.446,80
2	BBN2221660210080.	4.107,00	4.653,90	6.109,50
3	BBN2221660310080.	5.856,50	6.622,90	8.663,30

H2120 mm

No. of bays	Item no.	Melamine EUR	Painted EUR	Veneer EUR
1	BBN2221760110080.	2.524,80	2.866,40	3.777,20
2	BBN2221760210080.	4.498,80	5.085,00	6.646,80
3	BBN2221760310080.	6.406,70	7.225,50	9.407,50

LINGO ROUND SHELVING SYSTEM

18° - STEEL BACK PANEL - ADJUSTABLE FEET - WITH TOP PLATE - LEFT STARTER SECTION

Painted and veneered Lingo Shelving Systems are FSC-certified.

H720 mm

No. of bays	Item no.	Melamine EUR	Painted EUR	Veneer EUR
1	BBN2222260110080.	1.461,10	1.683,10	2.276,60
2	BBN2222260210080.	2.710,50	3.117,40	4.204,80
3	BBN2222260310080.	3.893,50	4.473,80	6.023,80

H920 mm

No. of bays	Item no.	Melamine EUR	Painted EUR	Veneer EUR
1	BBN2222360110080.	1.652,70	1.899,30	2.556,60
2	BBN2222360210080.	3.025,70	3.469,50	4.652,60
3	BBN2222360310080.	4.332,30	4.961,80	6.639,40

H1220 mm

No. of bays	Item no.	Melamine EUR	Painted EUR	Veneer EUR
1	BBN2222460110080.	1.923,50	2.202,70	2.948,80
2	BBN2222460210080.	3.473,70	3.966,40	5.282,70
3	BBN2222460310080.	4.957,50	5.652,20	7.507,40

H1520 mm

No. of bays	Item no.	Melamine EUR	Painted EUR	Veneer EUR
1	BBN2222560110080.	2.050,30	2.337,30	3.103,80
2	BBN2222560210080.	3.705,60	4.210,00	5.556,90
3	BBN2222560310080.	5.294,50	6.004,80	7.900,80

H1820 mm

No. of bays	Item no.	Melamine EUR	Painted EUR	Veneer EUR
1	BBN2222660110080.	2.289,00	2.604,00	3.442,50
2	BBN2222660210080.	4.105,40	4.651,80	6.106,70
3	BBN2222660310080.	5.855,40	6.621,70	8.661,70

H2120 mm

No. of bays	Item no.	Melamine EUR	Painted EUR	Veneer EUR
1	BBN2222760110080.	2.522,40	2.863,60	3.772,90
2	BBN2222760210080.	4.497,20	5.082,90	6.644,00
3	BBN2222760310080.	6.405,60	7.224,30	9.405,90

LINGO ROUND SHELVING SYSTEM

18° - STEEL BACK PANEL - ADJUSTABLE FEET - WITH TOP PLATE - RIGHT STARTER SECTION

Painted and veneered Lingo Shelving Systems are FSC-certified.

H720 mm

No. of bays	Item no.	Melamine EUR	Painted EUR	Veneer EUR
1	BBN2223260110080.	1.461,10	1.683,10	2.276,60
2	BBN2223260210080.	2.710,50	3.117,40	4.204,80
3	BBN2223260310080.	3.893,50	4.473,80	6.023,80

H920 mm

No. of bays	Item no.	Melamine EUR	Painted EUR	Veneer EUR
1	BBN2223360110080.	1.652,70	1.899,30	2.556,60
2	BBN2223360210080.	3.025,70	3.469,50	4.652,60
3	BBN2223360310080.	4.332,30	4.961,80	6.639,40

H1220 mm

No. of bays	Item no.	Melamine EUR	Painted EUR	Veneer EUR
1	BBN2223460110080.	1.923,50	2.202,70	2.948,80
2	BBN2223460210080.	3.473,70	3.966,40	5.282,70
3	BBN2223460310080.	4.957,50	5.652,20	7.507,40

H1520 mm

No. of bays	Item no.	Melamine EUR	Painted EUR	Veneer EUR
1	BBN2223560110080.	2.050,30	2.337,30	3.103,80
2	BBN2223560210080.	3.705,60	4.210,00	5.556,90
3	BBN2223560310080.	5.294,50	6.004,80	7.900,80

H1820 mm

No. of bays	Item no.	Melamine EUR	Painted EUR	Veneer EUR
1	BBN2223660110080.	2.289,00	2.604,00	3.442,50
2	BBN2223660210080.	4.105,40	4.651,80	6.106,70
3	BBN2223660310080.	5.855,40	6.621,70	8.661,70

H2120 mm

No. of bays	Item no.	Melamine EUR	Painted EUR	Veneer EUR
1	BBN2223760110080.	2.522,40	2.863,60	3.772,90
2	BBN2223760210080.	4.497,20	5.082,90	6.644,00
3	BBN2223760310080.	6.405,60	7.224,30	9.405,90

LINGO ROUND SHELVING SYSTEM

18° - STEEL BACK PANEL - ADJUSTABLE FEET - WITH TOP PLATE - INTERMEDIATE SECTION

Painted and veneered Lingo Shelving Systems are FSC-certified.

H720 mm

No. of bays	Item no.	Melamine EUR	Painted EUR	Veneer EUR
1	BBN2224260110080.	1.209,50	1.387,30	1.862,20
2	BBN2224260210080.	2.436,40	2.795,40	3.753,70
3	BBN2224260310080.	3.629,50	4.163,40	5.589,10

H920 mm

No. of bays	Item no.	Melamine EUR	Painted EUR	Veneer EUR
1	BBN2224360110080.	1.333,10	1.523,20	2.030,00
2	BBN2224360210080.	2.683,60	3.067,20	4.089,30
3	BBN2224360310080.	4.000,30	4.571,10	6.092,50

H1220 mm

No. of bays	Item no.	Melamine EUR	Painted EUR	Veneer EUR
1	BBN2224460110080.	1.510,30	1.716,70	2.267,90
2	BBN2224460210080.	3.038,00	3.454,20	4.565,10
3	BBN2224460310080.	4.531,90	5.151,60	6.806,20

H1520 mm

No. of bays	Item no.	Melamine EUR	Painted EUR	Veneer EUR
1	BBN2224560110080.	1.615,40	1.825,70	2.387,10
2	BBN2224560210080.	3.248,20	3.672,20	4.803,50
3	BBN2224560310080.	4.847,20	5.478,60	7.163,80

H1820 mm

No. of bays	Item no.	Melamine EUR	Painted EUR	Veneer EUR
1	BBN2224660110080.	1.776,50	2.000,80	2.598,20
2	BBN2224660210080.	3.570,40	4.022,40	5.225,70
3	BBN2224660310080.	5.330,50	6.003,90	7.797,10

H2120 mm

No. of bays	Item no.	Melamine EUR	Painted EUR	Veneer EUR
1	BBN2224760110080.	1.934,90	2.172,30	2.805,10
2	BBN2224760210080.	3.887,20	4.365,40	5.639,50
3	BBN2224760310080.	5.805,70	6.518,40	8.417,80

LINGO ROUND SHELVING SYSTEM

18° - STEEL BACK PANEL - ADJUSTABLE FEET - WITH TOP PLATE - LEFT END SECTION

Painted and veneered Lingo Shelving Systems are FSC-certified.

H720 mm

No. of bays	Item no.	Melamine EUR	Painted EUR	Veneer EUR
1	BBN2225260110080.	1.216,50	1.395,50	1.873,70
2	BBN2225260210080.	2.465,90	2.829,80	3.801,90
3	BBN2225260310080.	3.648,90	4.186,20	5.620,90

H920 mm

No. of bays	Item no.	Melamine EUR	Painted EUR	Veneer EUR
1	BBN2225360110080.	1.340,10	1.531,40	2.041,50
2	BBN2225360210080.	2.713,10	3.101,60	4.137,50
3	BBN2225360310080.	4.019,70	4.593,90	6.124,30

H1220 mm

No. of bays	Item no.	Melamine EUR	Painted EUR	Veneer EUR
1	BBN2225460110080.	1.517,30	1.724,90	2.279,40
2	BBN2225460210080.	3.067,50	3.488,60	4.613,30
3	BBN2225460310080.	4.551,30	5.174,40	6.838,00

H1520 mm

No. of bays	Item no.	Melamine EUR	Painted EUR	Veneer EUR
1	BBN2225560110080.	1.622,40	1.833,90	2.398,60
2	BBN2225560210080.	3.277,70	3.706,60	4.851,70
3	BBN2225560310080.	4.866,60	5.501,40	7.195,60

H1820 mm

No. of bays	Item no.	Melamine EUR	Painted EUR	Veneer EUR
1	BBN2225660110080.	1.783,50	2.009,00	2.609,70
2	BBN2225660210080.	3.599,90	4.056,80	5.273,90
3	BBN2225660310080.	5.349,90	6.026,70	7.828,90

H2120 mm

No. of bays	Item no.	Melamine EUR	Painted EUR	Veneer EUR
1	BBN2225760110080.	1.941,90	2.180,50	2.816,60
2	BBN2225760210080.	3.916,70	4.399,80	5.687,70
3	BBN2225760310080.	5.825,10	6.541,20	8.449,60

LINGO ROUND SHELVING SYSTEM

18° - STEEL BACK PANEL - ADJUSTABLE FEET - WITH TOP PLATE - RIGHT END SECTION

Painted and veneered Lingo Shelving Systems are FSC-certified.

H720 mm

No. of bays	Item no.	Melamine EUR	Painted EUR	Veneer EUR
1	BBN2226260110080.	1.216,50	1.395,50	1.873,70
2	BBN2226260210080.	2.465,90	2.829,80	3.801,90
3	BBN2226260310080.	3.648,90	4.186,20	5.620,90

H920 mm

No. of bays	Item no.	Melamine EUR	Painted EUR	Veneer EUR
1	BBN2226360110080.	1.340,10	1.531,40	2.041,50
2	BBN2226360210080.	2.713,10	3.101,60	4.137,50
3	BBN2226360310080.	4.019,70	4.593,90	6.124,30

H1220 mm

No. of bays	Item no.	Melamine EUR	Painted EUR	Veneer EUR
1	BBN2226460110080.	1.517,30	1.724,90	2.279,40
2	BBN2226460210080.	3.067,50	3.488,60	4.613,30
3	BBN2226460310080.	4.551,30	5.174,40	6.838,00

H1520 mm

No. of bays	Item no.	Melamine EUR	Painted EUR	Veneer EUR
1	BBN2226560110080.	1.622,40	1.833,90	2.398,60
2	BBN2226560210080.	3.277,70	3.706,60	4.851,70
3	BBN2226560310080.	4.866,60	5.501,40	7.195,60

H1820 mm

No. of bays	Item no.	Melamine EUR	Painted EUR	Veneer EUR
1	BBN2226660110080.	1.783,50	2.009,00	2.609,70
2	BBN2226660210080.	3.599,90	4.056,80	5.273,90
3	BBN2226660310080.	5.349,90	6.026,70	7.828,90

H2120 mm

No. of bays	Item no.	Melamine EUR	Painted EUR	Veneer EUR
1	BBN2226760110080.	1.941,90	2.180,50	2.816,60
2	BBN2226760210080.	3.916,70	4.399,80	5.687,70
3	BBN2226760310080.	5.825,10	6.541,20	8.449,60

LINGO ROUND SHELVING SYSTEM

BBN231 - 18° - STEEL BACK FRAME - CASTOR PLATE - FOR TOP SHELF



LINGO ROUND SHELVING SYSTEM

BBN231 - 18° - STEEL BACK FRAME - CASTOR PLATE - FOR TOP SHELF

Round shelving system with wooden panels, steel back frame and castor plate. To be used with top shelf.

- Prices based on steel price group 1 and wooden price group A (see Design Options pages 6-9).
- For top shelves, see from page 340
- For shelves, see from page 328

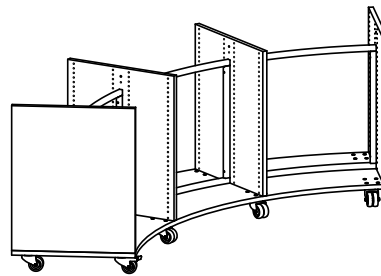
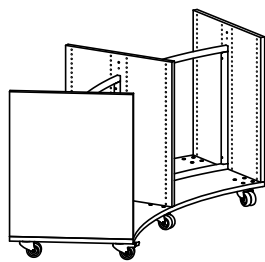
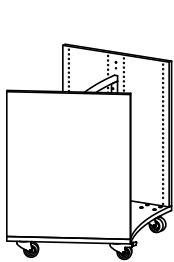

Double-sided H920 mm - 1/2/3 bays

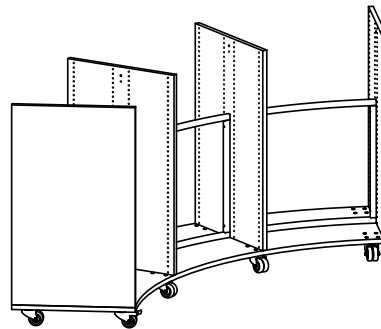
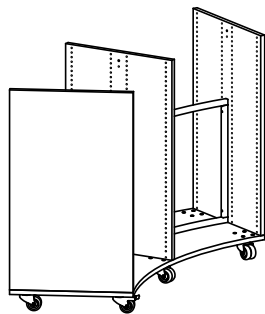
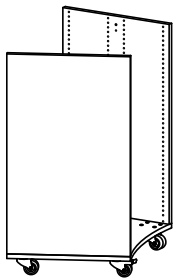

Double-sided H1220 mm - 1/2/3 bays

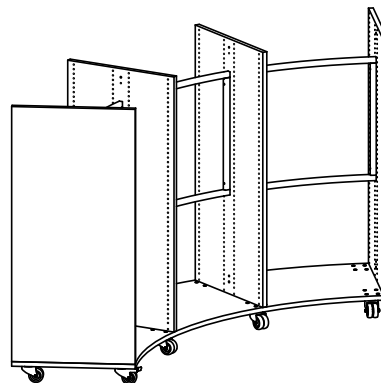
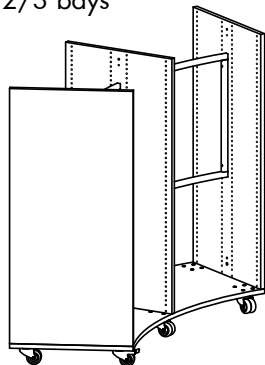
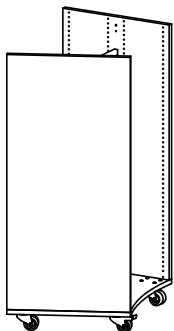

Double-sided H1520 mm - 1/2/3 bays

LINGO ROUND SHELVING SYSTEM

18° - STEEL BACK FRAME - CASTOR PLATE - FOR TOP SHELF

Painted and veneered Lingo Shelving Systems are FSC-certified.

H920 mm

No. of bays	Item no.	Melamine EUR	Painted EUR	Veneer EUR
1	BBN231136010006.	1.925,30	2.218,20	2.998,60
2	BBN231136020006.	3.495,80	4.018,90	5.412,70
3	BBN231136030006.	4.992,20	5.732,40	7.705,00

H1220 mm

No. of bays	Item no.	Melamine EUR	Painted EUR	Veneer EUR
1	BBN231146010006.	2.112,50	2.438,00	3.307,20
2	BBN231146020006.	3.776,60	4.348,60	5.875,60
3	BBN231146030006.	5.366,60	6.172,00	8.322,20

H1520 mm

No. of bays	Item no.	Melamine EUR	Painted EUR	Veneer EUR
1	BBN231156010006.	2.155,90	2.489,20	3.378,80
2	BBN231156020006.	3.841,70	4.425,40	5.983,00
3	BBN231156030006.	5.453,40	6.274,40	8.465,40

LINGO ROUND SHELVING SYSTEM

18° - STEEL BACK FRAME - CASTOR PLATE - FOR TOP SHELF

LINGO ROUND SHELVING SYSTEM

BBN231 - 18° - HIGH STEEL BACK PANEL - CASTOR PLATE - FOR TOP SHELF



LINGO ROUND SHELVING SYSTEM

BBN231 - 18° - HIGH STEEL BACK PANEL - CASTOR PLATE - FOR TOP SHELF

Round shelving system with wooden panels, high steel back panel and castor plate.
To be used with top shelves WT5 standard depth top shelf.

- Prices based on steel price group 1 and wooden price group A (see Design Options pages 6-9).
- For top shelves, see from page 340
- For shelves, see from page 328

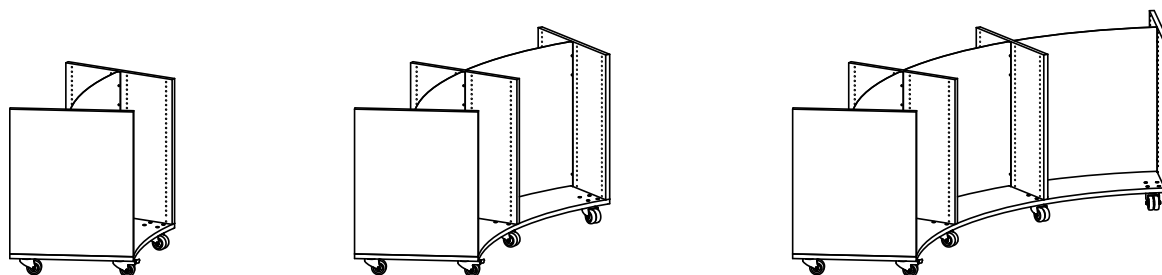

Double-sided H920 mm - 1/2/3 bays

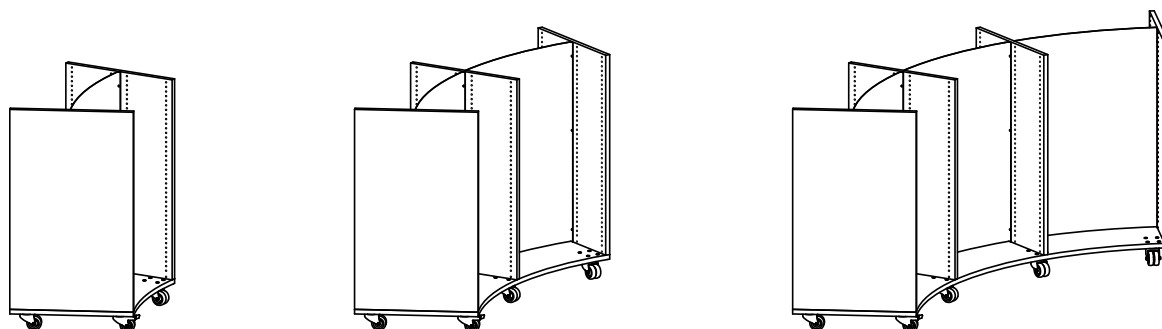

Double-sided H1220 mm - 1/2/3 bays

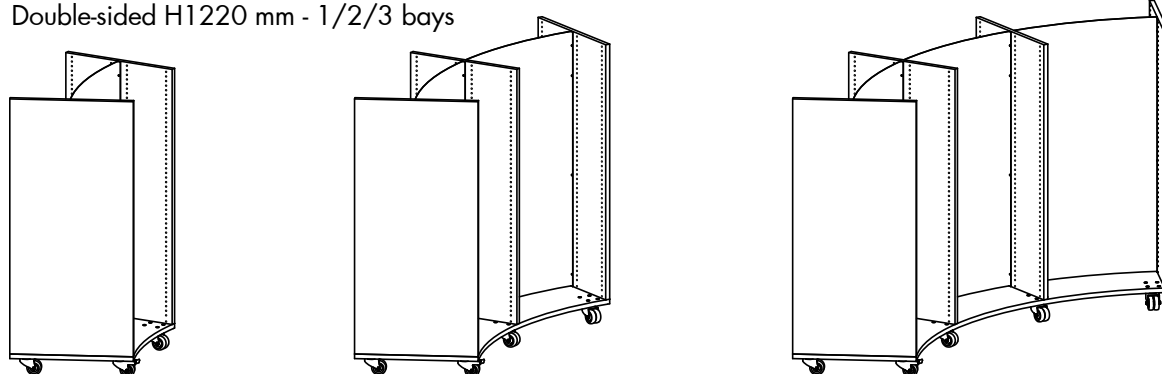

Double-sided H1520 mm - 1/2/3 bays

LINGO ROUND SHELVING SYSTEM

18° - HIGH STEEL BACK PANEL - CASTOR PLATE - FOR TOP SHELF

Painted and veneered Lingo Shelving Systems are FSC-certified.

H920 mm

No. of bays	Item no.	Melamine EUR	Painted EUR	Veneer EUR
1	BBN231136010008.	1.914,20	2.207,10	2.987,50
2	BBN231136020008.	3.473,60	3.996,70	5.390,50
3	BBN231136030008.	4.958,90	5.699,10	7.671,70

H1220 mm

No. of bays	Item no.	Melamine EUR	Painted EUR	Veneer EUR
1	BBN231146010008.	2.185,00	2.510,50	3.379,70
2	BBN231146020008.	3.921,60	4.493,60	6.020,60
3	BBN231146030008.	5.584,10	6.389,50	8.539,70

H1520 mm

No. of bays	Item no.	Melamine EUR	Painted EUR	Veneer EUR
1	BBN231156010008.	2.311,80	2.645,10	3.534,70
2	BBN231156020008.	4.153,50	4.737,20	6.294,80
3	BBN231156030008.	5.921,10	6.742,10	8.933,10

LINGO ROUND SHELVING SYSTEM

18° - HIGH STEEL BACK PANEL - CASTOR PLATE - FOR TOP SHELF

LINGO ROUND SHELVING SYSTEM

BBN231 - 18° - LOW STEEL BACK PANEL - CASTOR PLATE - FOR TOP SHELF



LINGO ROUND SHELVING SYSTEM

BBN231 - 18° - LOW STEEL BACK PANEL - CASTOR PLATE - FOR TOP SHELF

Round shelving system with wooden panels, low steel back panel and castor plate.
To be used with top shelves WT5 full depth and WT5 double-sided top shelf.

- Prices based on steel price group 1 and wooden price group A (see Design Options pages 6-9).
- For top shelves, see from page 340
- For shelves, see from page 328
- For slat panels, see from page 351 (note slate panel replaces outer panel)

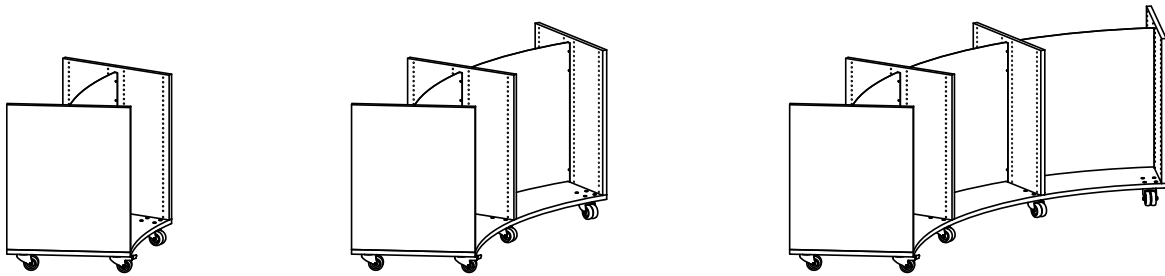

Double-sided H920 mm - 1/2/3 bays

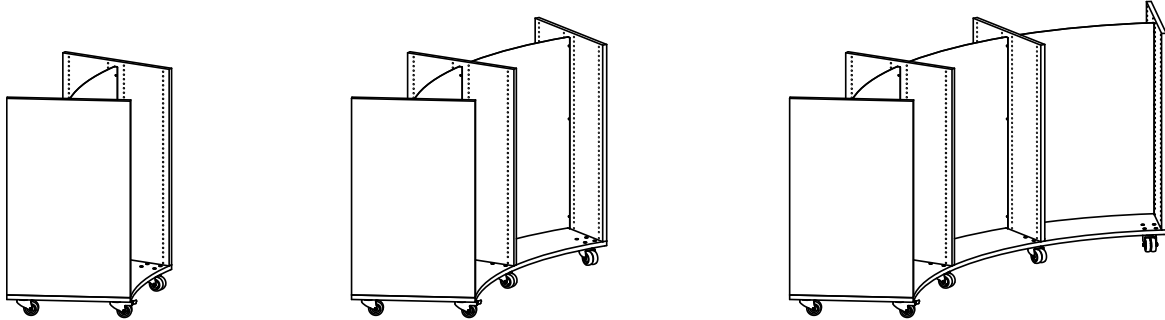

Double-sided H1220 mm - 1/2/3 bays

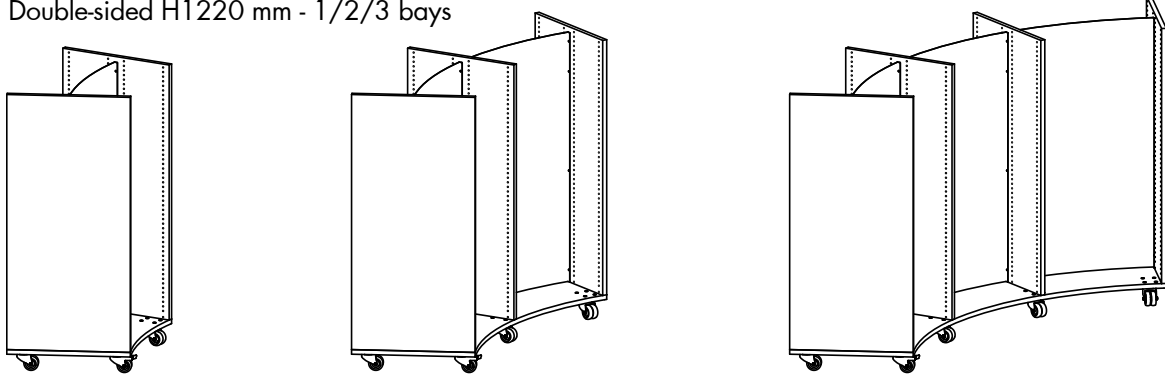

Double-sided H1520 mm - 1/2/3 bays

LINGO ROUND SHELVING SYSTEM

18° - LOW STEEL BACK PANEL - CASTOR PLATE - FOR TOP SHELF

Painted and veneered Lingo Shelving Systems are FSC-certified.

H920 mm

No. of bays	Item no.	Melamine EUR	Painted EUR	Veneer EUR
1	BBN231136010007.	1.914,20	2.207,10	2.987,50
2	BBN231136020007.	3.473,60	3.996,70	5.390,50
3	BBN231136030007.	4.958,90	5.699,10	7.671,70

H1220 mm

No. of bays	Item no.	Melamine EUR	Painted EUR	Veneer EUR
1	BBN231146010007.	2.185,00	2.510,50	3.379,70
2	BBN231146020007.	3.921,60	4.493,60	6.020,60
3	BBN231146030007.	5.584,10	6.389,50	8.539,70

H1520 mm

No. of bays	Item no.	Melamine EUR	Painted EUR	Veneer EUR
1	BBN231156010007.	2.311,80	2.645,10	3.534,70
2	BBN231156020007.	4.153,50	4.737,20	6.294,80
3	BBN231156030007.	5.921,10	6.742,10	8.933,10

LINGO ROUND SHELVING SYSTEM

18° - LOW STEEL BACK PANEL - CASTOR PLATE - FOR TOP SHELF

LINGO ROUND SHELVING SYSTEM

BBN232 - 18° - STEEL BACK FRAME - CASTOR PLATE - WITH OVERLAYING TOP PLATE



LINGO ROUND SHELVING SYSTEM

BBN232 - 18° - STEEL BACK FRAME - CASTOR PLATE - WITH OVERLAYING TOP PLATE

Round shelving system with wooden panels, steel back frame, castor plate and overlaying top plate.

- Prices based on steel price group 1 and wooden price group A (see Design Options pages 6-9).
- For shelves, see from page 328

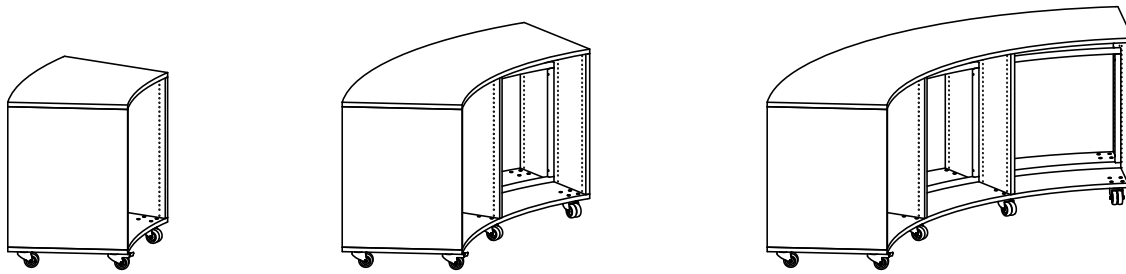

Double-sided H920 mm - 1/2/3 bays

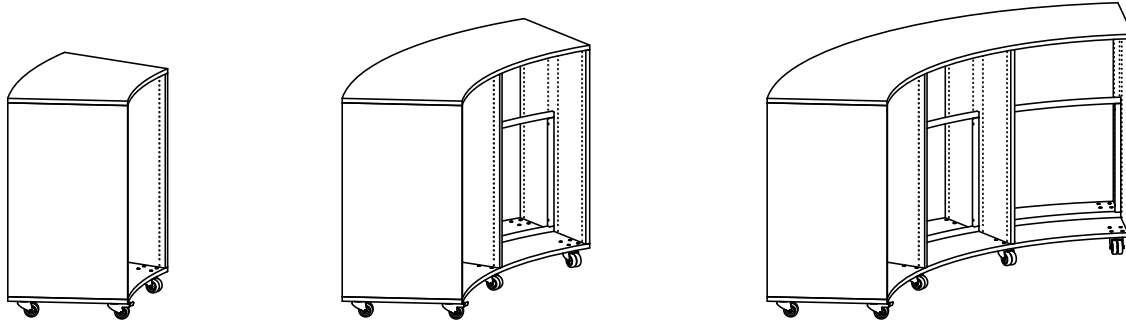

Double-sided H1220 mm - 1/2/3 bays

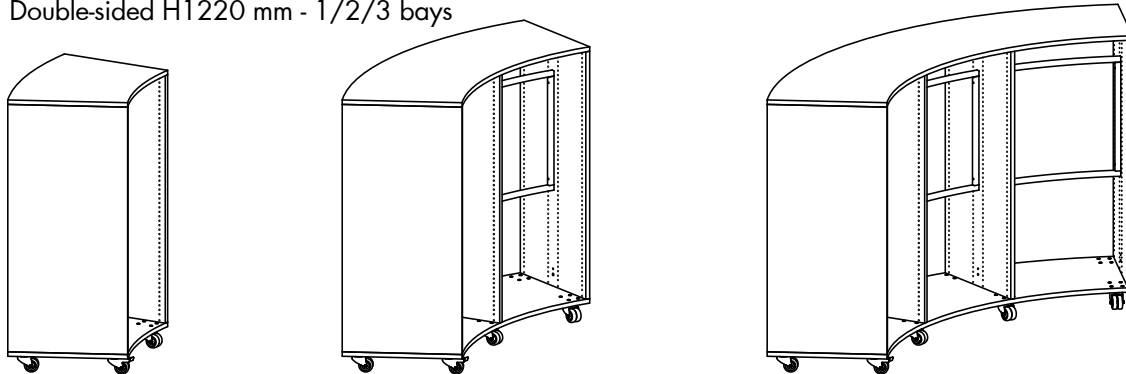

Double-sided H1520 mm - 1/2/3 bays

LINGO ROUND SHELVING SYSTEM

18° - STEEL BACK FRAME - CASTOR PLATE - WITH OVERLAYING TOP PLATE

Painted and veneered Lingo Shelving Systems are FSC-certified.

H920 mm

No. of bays	Item no.	Melamine EUR	Painted EUR	Veneer EUR
1	BBN232136011006.	2.699,10	3.128,40	4.273,20
2	BBN232136021006.	5.073,10	5.874,60	8.010,60
3	BBN232136031006.	7.306,90	8.455,50	11.517,30

H1220 mm

No. of bays	Item no.	Melamine EUR	Painted EUR	Veneer EUR
1	BBN232146011006.	2.886,30	3.348,20	4.581,80
2	BBN232146021006.	5.353,90	6.204,30	8.473,50
3	BBN232146031006.	7.681,30	8.895,10	12.134,50

H1520 mm

No. of bays	Item no.	Melamine EUR	Painted EUR	Veneer EUR
1	BBN232156011006.	2.929,70	3.399,40	4.653,40
2	BBN232156021006.	5.419,00	6.281,10	8.580,90
3	BBN232156031006.	7.768,10	8.997,50	12.277,70

LINGO ROUND SHELVING SYSTEM

18° - STEEL BACK FRAME - CASTOR PLATE - WITH OVERLAYING TOP PLATE

LINGO ROUND SHELVING SYSTEM

BBN232 - 18° - STEEL BACK PANEL - CASTOR PLATE - WITH OVERLAYING TOP PLATE



LINGO ROUND SHELVING SYSTEM

BBN232 - 18° - STEEL BACK PANEL - CASTOR PLATE - WITH OVERLAYING TOP PLATE

Round shelving system with wooden panels, steel back panel, castor plate and overlaying top plate.

- Prices based on steel price group 1 and wooden price group A (see Design Options pages 6-9).
- For shelves, see from page 328

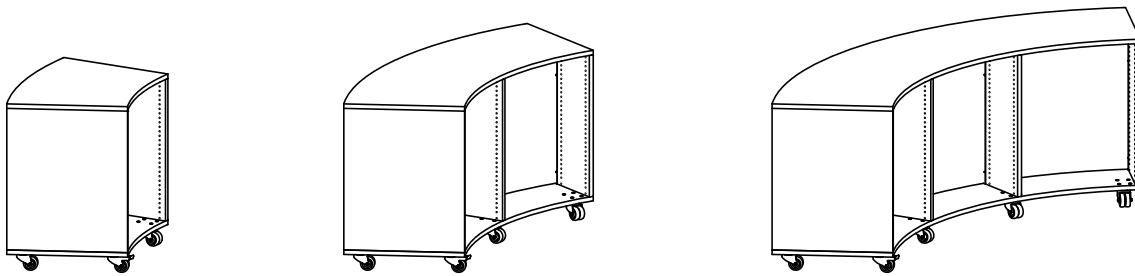

Double-sided H920 mm - 1/2/3 bays

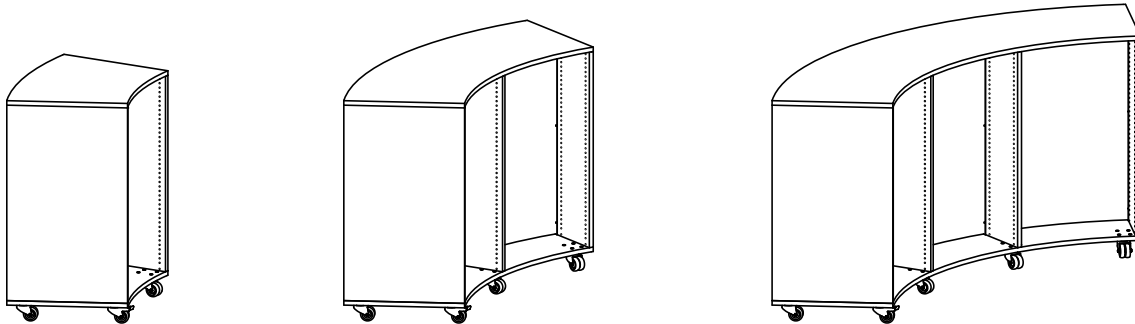

Double-sided H1220 mm - 1/2/3 bays

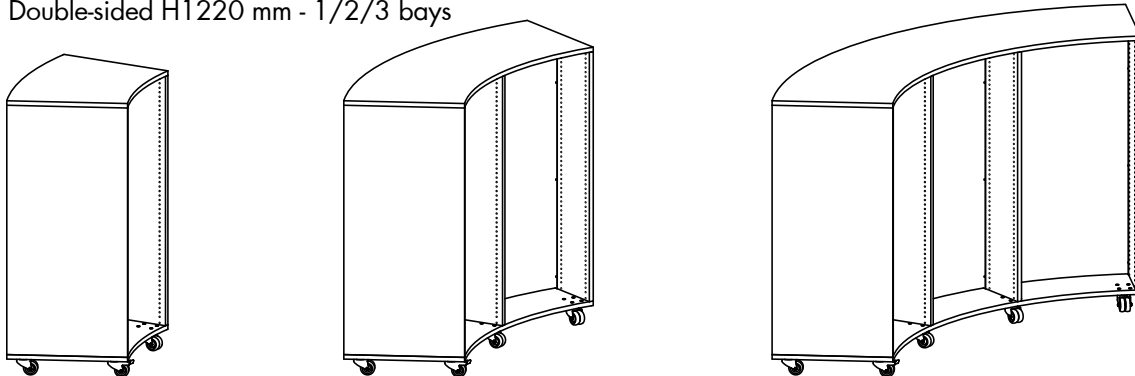

Double-sided H1520 mm - 1/2/3 bays

LINGO ROUND SHELVING SYSTEM

18° - STEEL BACK PANEL - CASTOR PLATE - WITH OVERLAYING TOP PLATE

Painted and veneered Lingo Shelving Systems are FSC-certified.

H920 mm

No. of bays	Item no.	Melamine EUR	Painted EUR	Veneer EUR
1	BBN232136011008.	2.688,00	3.117,30	4.262,10
2	BBN232136021008.	5.050,90	5.852,40	7.988,40
3	BBN232136031008.	7.273,60	8.422,20	11.484,00

H1220 mm

No. of bays	Item no.	Melamine EUR	Painted EUR	Veneer EUR
1	BBN232146011008.	2.958,80	3.420,70	4.654,30
2	BBN232146021008.	5.498,90	6.349,30	8.618,50
3	BBN232146031008.	7.898,80	9.112,60	12.352,00

H1520 mm

No. of bays	Item no.	Melamine EUR	Painted EUR	Veneer EUR
1	BBN232156011008.	3.085,60	3.555,30	4.809,30
2	BBN232156021008.	5.730,80	6.592,90	8.892,70
3	BBN232156031008.	8.235,80	9.465,20	12.745,40

LINGO ROUND SHELVING SYSTEM

18° - STEEL BACK PANEL - CASTOR PLATE - WITH OVERLAYING TOP PLATE



COMPONENTS

CHECK LIST

When constructing your round shelving, there are many factors to be taken into consideration and most importantly, you must remember to order all parts. Below you will find a check list of components you need to consider when constructing your round wooden shelving.

SHELVES

The following factors are all to be considered before choosing the shelf:

- steel or wooden shelf
- steel or wooden topshelf, or wooden overlaying top plate

CASTORS

Extra components to complete the function and design of shelving:

- castor frame with castors
- castor plate with castors
- plinth

PANELS

The following factors are all to be considered before choosing the panel:

- height (720/920/1220/1520/1820/2120 mm)
- stationary or mobile (adjustable feet/castor frame/castor plate)
- top (top shelf/overlaying top plate)

CONNECTION ELEMENTS

To support the shelving and determine the design of shelving system, you must choose between one of the 2 connection elements. Note that if you wish to combine straight and round shelving and maintain the same design, you must use the steel back frame.:

- steel back frame/ steel back panel

SHELVES

S5 - ROUND STEEL SHELVES

See below for overview of standard round steel shelves:

S5 - ROUND STEEL SHELF WITH STEEL BACKEDGE

Details:

- 26°/18°
- Inner & outer
- Depth 300 mm
- Steel backedge H47 mm
- Steel brackets
- Max. weight 80 kg.

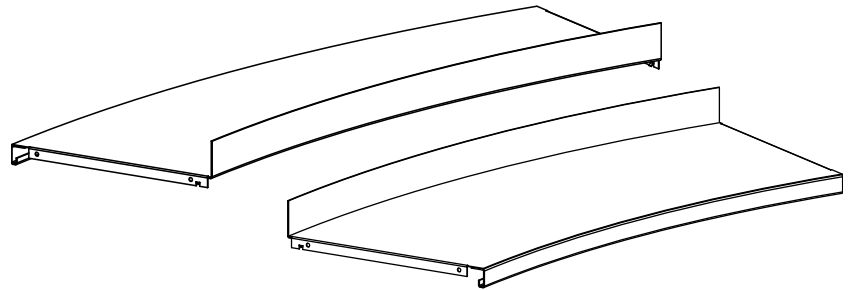

Use with:

- WT5 - wooden top shelf
- WO5 - wooden overlaying top plate

Note:

- Steel shelves placed at the bottom, must always be fixed with screws.

SHELVES

S6 - ROUND STEEL SHELVES

See below for overview of standard round steel shelves:

S6 - ROUND STEEL SHELF

Details:

- 26°/18°
- Inner & outer
- Depth 300 mm
- Steel brackets
- Max. weight 80 kg.

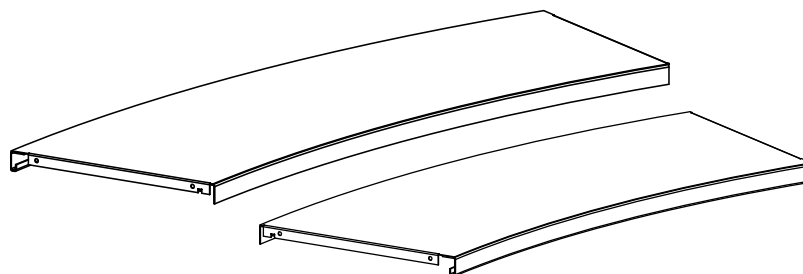

Use with:

- WT5 - wooden top shelf
- WO5 - wooden overlaying top plate

Note:

- Steel shelves placed at the bottom, must always be fixed with screws.

SHELVES

S5 - ROUND STEEL SHELF WITH STEEL BACKEDGE

S5 - intermediate, round, steel shelf with steel backedge and steel brackets - inner

Steel backedge 47 mm. With brackets and fittings.	Degree	Shelf depth mm	Item no.	Price EUR
	26	300	BBN290611	228,10
	18	300	BBN290811	228,10

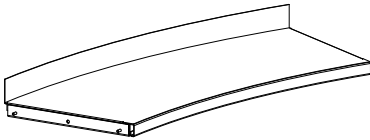

S5 - intermediate, round, steel shelf with steel backedge and steel brackets - outer

Steel backedge 47 mm. With brackets, fittings and shelf strengthner.	Degree	Shelf depth mm	Item no.	Price EUR
	26	300	BBN290621	258,60
	18	300	BBN290821	258,60

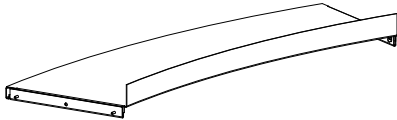

SHELVES

S5 - ROUND STEEL SHELF WITH STEEL BACKEDGE & BRACKETS

S5 - intermediate, round, steel shelf with steel backedge - inner

Steel backedge 47 mm.
Brackets to be ordered
separately, see below.

Degree	Shelf depth mm
26	300
18	300

Item no.	Price EUR
BN26561	210,10
BN26581	210,10

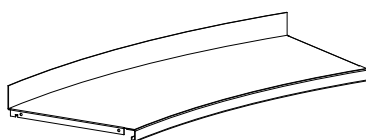

S5 - intermediate, round, steel shelf with steel backedge - outer

Steel backedge 47 mm.
With shelf strengthner.
Brackets to be ordered
separately, see below.

Degree	Shelf depth mm
26	300
18	300

Item no.	Price EUR
BN26562	240,60
BN26582	240,60

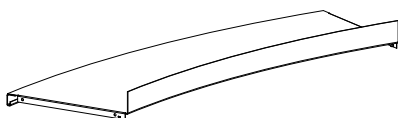

Steel bracket - for S5 & S6

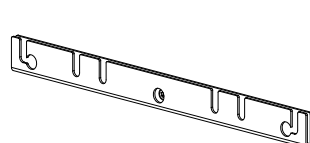

Shelf depth mm
300

Item no.	Price EUR
BN0843	9,00

SHELVES

S6 - ROUND STEEL SHELF

S6 - intermediate, round, steel shelf with steel brackets - inner

With brackets and fittings.	Degree	Shelf depth mm	Item no.	Price EUR
	26	300	BBN290612	228,10
	18	300	BBN290812	228,10

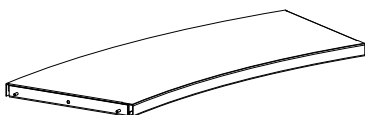

S6 - intermediate, round, steel shelf with steel brackets - outer

With brackets, fittings and shelf strengthenner.	Degree	Shelf depth mm	Item no.	Price EUR
	26	300	BBN290622	258,60
	18	300	BBN290822	258,60

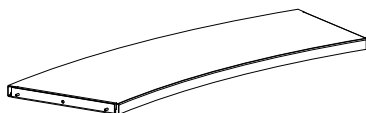

SHELVES

S6 - ROUND STEEL SHELF & BRACKETS

S6 - intermediate, round, steel shelf - inner

Brackets to be ordered separately, see below.

Degree	Shelf depth mm
26	300
18	300

Item no.

Price
EUR

BN26661

210,10

BN26681

210,10

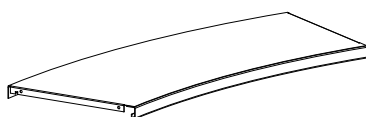

S6 - intermediate, round, steel shelf - outer

With shelf strengthner.
Brackets to be ordered separately, see below.

Degree	Shelf depth mm
26	300
18	300

Item no.

Price
EUR

BN26662

240,60

BN26682

240,60



Steel bracket - for S5 & S6

Shelf depth mm
300

Item no.

Price
EUR

BN0843

9,00

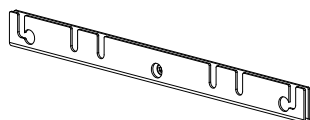

SHELVES

W5 & W6 - ROUND WOODEN SHELVES

See below for overview of standard round wooden shelves:

W5 - ROUND WOODEN SHELF WITH H47 MM STEEL BACKEDGE

Details:

- 26°/18°
- Depth 300 mm
- Painted/veneer
- Steel backedge H47 mm
- Snapfix for intermediate shelf/
snapfix and screws for bottom shelf
- Max. weight 80 kg.
- Blockboard

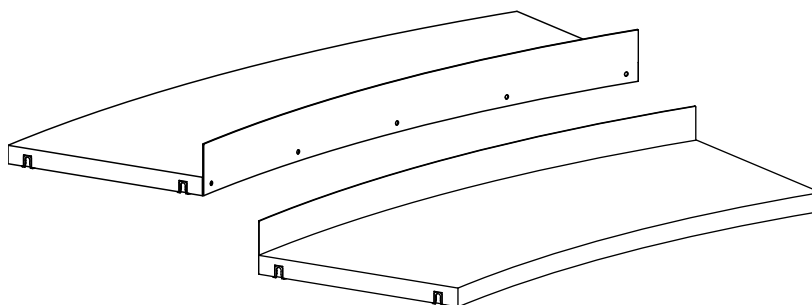

Use with:

- S6 - round steel top shelf
- WT5 - round wooden top shelf
- WO5 - round wooden overlaying top plate

Note:

- Wooden shelves placed at the bottom, must always be fixed with snapfix and screws.

W6 - ROUND WOODEN SHELF

Details:

- 26°/18°
- Depth 300 mm
- Painted/veneer
- No backedge
- Snapfix for intermediate shelf/
snapfix and screws for bottom shelf
- Max. weight 80 kg.
- Blockboard

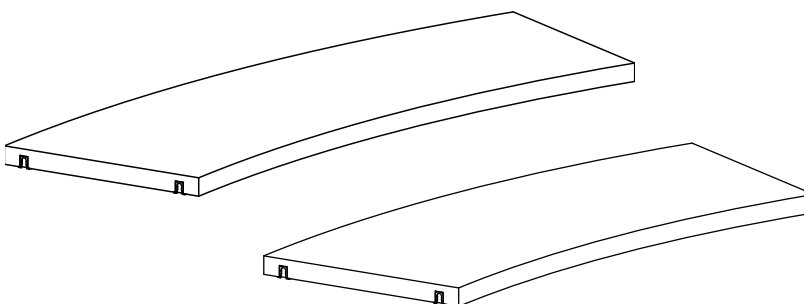

Use with:

- S6 - round steel top shelf
- WT5 - wooden top shelf
- WO5 - wooden overlaying top plate

Note:

- Wooden shelves placed at the bottom, must always be fixed with snapfix and screws.

SHELVES

W7 & W8 - ROUND WOODEN SHELVES

See below for overview of standard round wooden shelves:

W7 - ROUND WOODEN SHELF WITH H47 MM STEEL BACKEDGE

Details:

- 26°/18°
- Depth 300 mm
- Melamine
- Steel backedge H47 mm
- Snapfix for intermediate shelf/
snapfix and screws for bottom shelf
- Max. weight 60 kg.
- Particleboard

Use with:

- S6 - round steel top shelf
- WT7 - wooden top shelf
- WO5 - wooden overlaying top plate

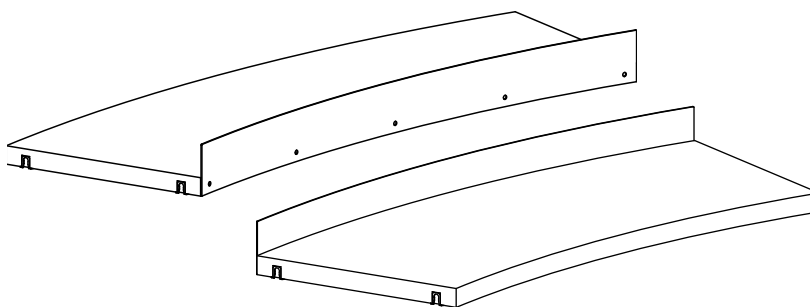

Note:

- Wooden shelves placed at the bottom, must always be fixed with snapfix and screws.

W8 - ROUND WOODEN SHELF

Details:

- 26°/18°
- Depth 300 mm
- Melamine
- No backedge
- Snapfix for intermediate shelf/
snapfix and screws for bottom shelf
- Max. weight 60 kg.
- Particleboard

Use with:

- S6 - round steel top shelf
- WT7 - wooden top shelf
- WO5 - wooden overlaying top plate

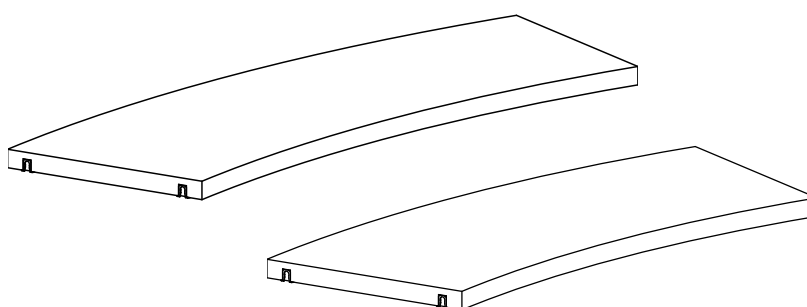

Note:

- Wooden shelves placed at the bottom, must always be fixed with snapfix and screws.

SHELVES

W5 - ROUND WOODEN SHELF WITH H47 MM BACKEDGE AND COMPONENTS

Painted and veneered shelves are FSC-certified.

W5 - intermediate, round wooden shelf with steel backedge and snapfix - inner

H47 mm steel backedge. Blockboard. Incl. fittings (snapfix).	Degree	Shelf depth mm	Item no.	Melamine EUR	Painted EUR	Veneer EUR
	26	300	BN267611.ZZZZZ3	-	404,30	560,80
	18	300	BN267811.ZZZZZ3	-	404,30	560,80

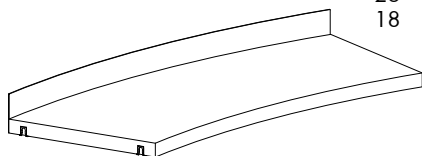

W5 - intermediate, round wooden shelf with steel backedge and snapfix - outer

H47 mm steel backedge. Blockboard. Incl. fittings (snapfix).	Degree	Shelf depth mm	Item no.	Melamine EUR	Painted EUR	Veneer EUR
	26	300	BN267621.ZZZZZ3	-	484,00	672,20
	18	300	BN267821.ZZZZZ3	-	484,00	672,20

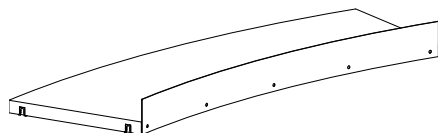

W5 - bottom, round wooden shelf with steel backedge, snapfix and screws - inner

H47 mm steel backedge. Blockboard. Incl. fittings (snapfix and screws).	Degree	Shelf depth mm	Item no.	Melamine EUR	Painted EUR	Veneer EUR
	26	300	BN267611.ZZZZZ2	-	404,30	560,80
	18	300	BN267811.ZZZZZ2	-	404,30	560,80

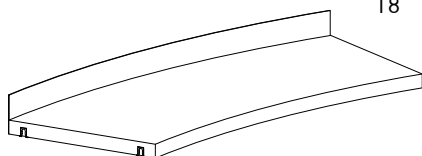

W5 - bottom, round wooden shelf with steel backedge, snapfix and screws - outer

H47 mm steel backedge. Blockboard. Incl. fittings (snapfix and screws).	Degree	Shelf depth mm	Item no.	Melamine EUR	Painted EUR	Veneer EUR
	26	300	BN267621.ZZZZZ2	-	484,00	672,20
	18	300	BN267821.ZZZZZ2	-	484,00	672,20

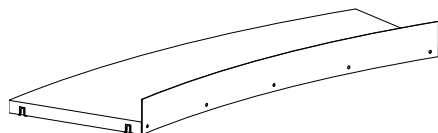

SHELVES

W6 - ROUND WOODEN SHELF AND COMPONENTS

Painted and veneered shelves are FSC-certified.

W6 - intermediate, round wooden shelf without backedge, with snapfix - inner

Blockboard. Incl. fittings (snapfix).	Degree	Shelf depth mm	Item no.	Melamine EUR	Painted EUR	Veneer EUR
	26	300	BN267610.ZZZZZ3	-	362,30	507,30
	18	300	BN267810.ZZZZZ3	-	362,30	507,30

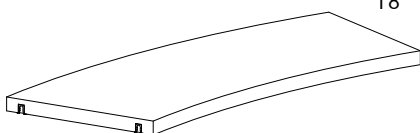

W6 - intermediate, round wooden shelf without backedge, with snapfix - outer

Blockboard. Incl. fittings (snapfix).	Degree	Shelf depth mm	Item no.	Melamine EUR	Painted EUR	Veneer EUR
	26	300	BN267620.ZZZZZ3	-	442,00	618,80
	18	300	BN267820.ZZZZZ3	-	442,00	618,80

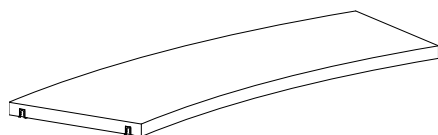

W6 - bottom, round wooden shelf without backedge, with snapfix and screws - inner

Blockboard. Incl. fittings (snapfix and screws).	Degree	Shelf depth mm	Item no.	Melamine EUR	Painted EUR	Veneer EUR
	26	300	BN267610.ZZZZZ2	-	362,30	507,30
	18	300	BN267810.ZZZZZ2	-	362,30	507,30

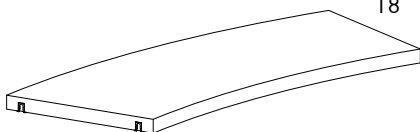

W6 - bottom, round wooden shelf without backedge, with snapfix and screws - outer

Blockboard. Incl. fittings (snapfix and screws).	Degree	Shelf depth mm	Item no.	Melamine EUR	Painted EUR	Veneer EUR
	26	300	BN267620.ZZZZZ2	-	442,00	618,80
	18	300	BN267820.ZZZZZ2	-	442,00	618,80

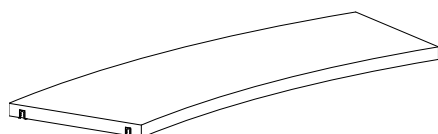

SHELVES

W7 - ROUND WOODEN SHELF WITH H47 MM BACKEDGE & COMPONENTS

W7 - intermediate, round wooden shelf with steel backedge and snapfix - inner

H47 mm steel backedge. Particleboard. Incl. fittings (snapfix)	Degree	Shelf depth mm	Item no.	Melamine EUR	Painted EUR	Veneer EUR
	26	300	BN270611.ZZZ3	343,70	-	-
	18	300	BN270811.ZZZ3	343,70	-	-

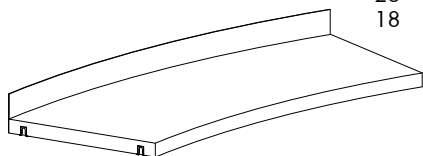

W7 - intermediate, round wooden shelf with steel backedge and snapfix - outer

H47 mm steel backedge. Particleboard. Incl. fittings (snapfix)	Degree	Shelf depth mm	Item no.	Laminate EUR	Painted EUR	Veneer EUR
	26	300	BN270621.ZZZ3	411,30	-	-
	18	300	BN270821.ZZZ3	411,30	-	-

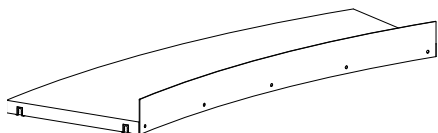

W7 - bottom, round wooden shelf with steel backedge, snapfix and screws - inner

H47 mm steel backedge. Particleboard Incl. fittings (snapfix)	Degree	Shelf depth mm	Item no.	Melamine EUR	Painted EUR	Veneer EUR
	26	300	BN270611.ZZZ2	343,70	-	-
	18	300	BN270811.ZZZ2	343,70	-	-

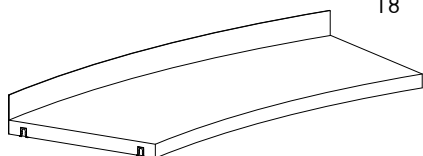

W7 - bottom, round wooden shelf with steel backedge, snapfix and screws - outer

H47 mm steel backedge. Particleboard. Incl. fittings (snapfix)	Degree	Shelf depth mm	Item no.	Laminate EUR	Painted EUR	Veneer EUR
	26	300	BN270621.ZZZ2	411,30	-	-
	18	300	BN270821.ZZZ2	411,30	-	-

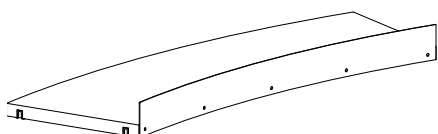

SHELVES

W8 - ROUND WOODEN SHELF

W8 - intermediate, round wooden shelf without backedge, with snapfix - inner

Particleboard. Incl. fittings (snapfix).	Degree	Shelf depth mm	Item no.	Melamine EUR	Painted EUR	Veneer EUR
	26	300	BN270610.ZZZ3	308,00	-	-
	18	300	BN270810.ZZZ3	308,00	-	-

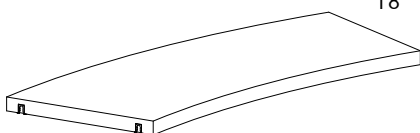

W8 - intermediate, round wooden shelf without backedge, with snapfix - outer

Particleboard. Incl. fittings (snapfix).	Degree	Shelf depth mm	Item no.	Laminate EUR	Painted EUR	Veneer EUR
	26	300	BN270620.ZZZ3	375,60	-	-
	18	300	BN270820.ZZZ3	375,60	-	-

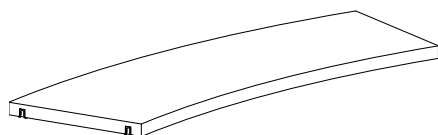

W8 - bottom, round wooden shelf without backedge, with snapfix and screws - inner

Particleboard. Incl. fittings (snapfix and screws).	Degree	Shelf depth mm	Item no.	Melamine EUR	Painted EUR	Veneer EUR
	26	300	BN270610.ZZZ2	308,00	-	-
	18	300	BN270810.ZZZ2	308,00	-	-

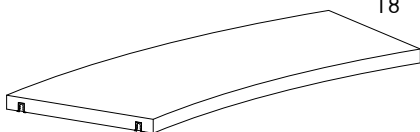

W8 - bottom, round wooden shelf without backedge, with snapfix and screws - outer

Particleboard. Incl. fittings (snapfix and screws).	Degree	Shelf depth mm	Item no.	Laminate EUR	Painted EUR	Veneer EUR
	26	300	BN270620.ZZZ2	375,60	-	-
	18	300	BN270820.ZZZ2	375,60	-	-

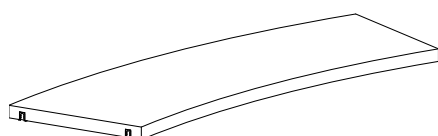

SHELVES

WT5 - ROUND WOODEN TOP SHELVES

Choose between a wooden top shelf (placed in between the wooden panels) or a wooden overlaying top plate (placed on top of the panels).

WT5 - ROUND WOODEN TOP SHELF

Details:

- 26°/18°
- Painted/veneer
- Single-sided standard depth inner & outer
Double-sided
- Snapfix and screws
- Max. weight 25 kg
- Particleboard

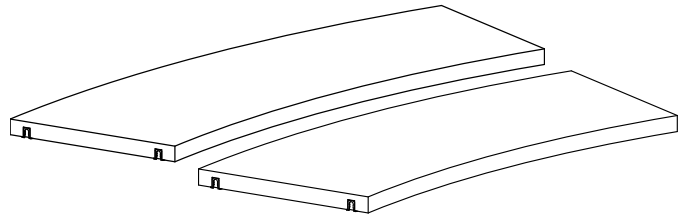

Use with:

- S5 - round steel shelves
- W5/W6/W7/W8 - round wooden shelves
- WP1/WP5 - wooden panel
- SBP5/SBP7 - round steel back panel for standard depth
SBP6/SBP8 - round steel back panel for double-sided

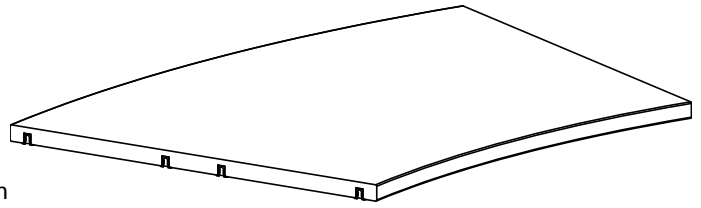

Note:

- Wooden top shelves must always be fixed with snapfix and screws.

SHELVES

WT7 - ROUND WOODEN TOP SHELVES

Choose between a wooden top shelf (placed in between the wooden panels) or a wooden overlaying top plate (placed on top of the panels).

WT7 - ROUND WOODEN TOP SHELF

Details:

- 26°/18°
- Melamine
- Single-sided standard depth inner & outer
Double-sided
- Snapfix and screws
- Max. weight 25 kg.
- Particleboard

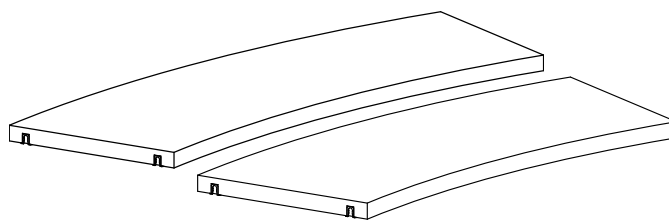

Use with:

- S5 - round steel shelves
- W5/W5/W7/W8 - round wooden shelves
- WP1/WP5 - wooden panel
- SBP5/SBP7 - round steel back panel for standard depth
SBP6/SBP8 - round steel back panel for double-sided

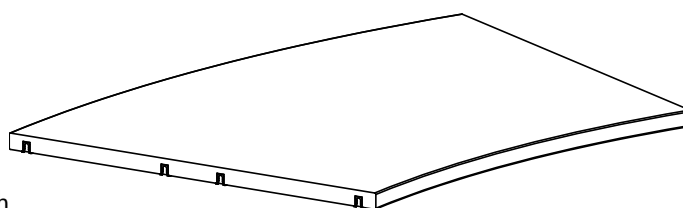

Note:

- Wooden top shelves must always be fixed with snapfix and screws.

SHELVES

WT5 - ROUND WOODEN TOP SHELF - PAINTED/VENEER

Painted and veneered shelves are FSC-certified.

WT5 - round single-sided wooden top shelf - standard depth - inner

Particleboard. Incl. fittings (snapfix and screws).	Degree	Shelf depth mm	Item no.	Melamine EUR	Painted EUR	Veneer EUR
	26	300	BN276561.	-	362,30	507,30
	18	300	BN276581.	-	362,30	507,30

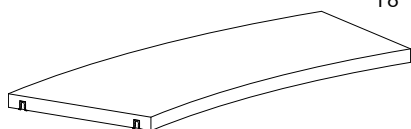

WT5 - round single-sided wooden top shelf - standard depth - outer

Particleboard. Incl. fittings (snapfix and screws).	Degree	Shelf depth mm	Item no.	Melamine EUR	Painted EUR	Veneer EUR
	26	300	BN276562.	-	442,00	618,80
	18	300	BN276582.	-	442,00	618,80

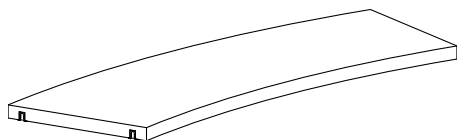

WT5 - round double-sided wooden top shelf

Particleboard. Incl. fittings (snapfix and screws).	Degree	Shelf depth mm	Item no.	Melamine EUR	Painted EUR	Veneer EUR
	26	300	BN276660.	-	804,30	1.125,90
	18	300	BN276680.	-	804,30	1.125,90

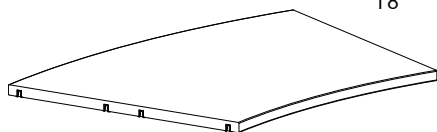

SHELVES

WT7 - ROUND WOODEN TOP SHELF - MELAMINE

WT7 - round single-sided wooden top shelf - standard depth - inner

Particleboard. Incl. fittings (snapfix and screws).	Degree	Shelf depth mm	Item no.	Melamine EUR	Painted EUR	Veneer EUR
	26	300	BN277561.	308,00	-	-
	18	300	BN277581.	308,00	-	-

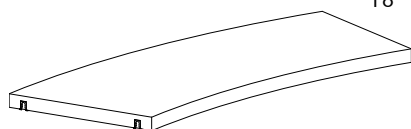

WT7 - round single-sided wooden top shelf - standard depth outer

Particleboard. Incl. fittings (snapfix and screws).	Degree	Shelf depth mm	Item no.	Melamine EUR	Painted EUR	Veneer EUR
	26	300	BN277562.	375,60	-	-
	18	300	BN277582.	375,60	-	-

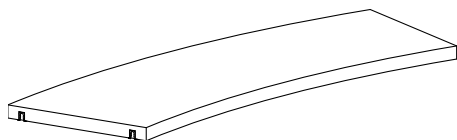

WT7 - round double-sided wooden top shelf

Particleboard. Incl. fittings (snapfix and screws).	Degree	Shelf depth mm	Item no.	Melamine EUR	Painted EUR	Veneer EUR
	26	300	BN277660.	683,50	-	-
	18	300	BN277680.	683,50	-	-

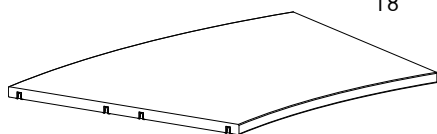

SHELVES

WO5 - ROUND WOODEN OVERLAYING TOP PLATE

Choose between a wooden top shelf (placed in between the wooden panels) or a wooden overlaying top plate (placed on top of the panels).

WO5 - ROUND WOODEN OVERLAYING TOP PLATE

Details:

- Melamine/painted/veneer
- Freestanding/outer/intermediate
- Max. weight 25 kg.
- Particle board

Use with:

- S5 - round steel shelves
- W5/W6/W7/W8 - round wooden shelves
- WP3/WP7 - wooden panel
- SBP5/7 - round steel back panel

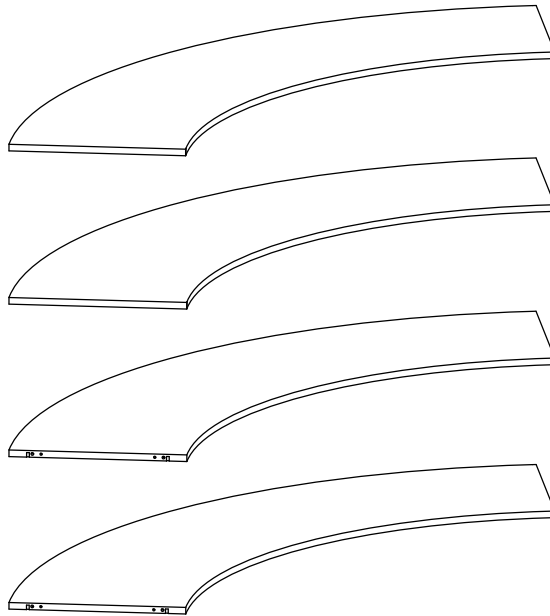

SHELVES

WO5 - ROUND WOODEN OVERLAYING TOP PLATE - DOUBLE-SIDED

Painted and veneered shelves are FSC-certified.

WO5 - round double-sided wooden overlaying top plate - freestanding

Particleboard. Incl. fittings.	Degree	Shelf depth mm	No. of bays	Item no.	Melamine EUR	Painted EUR	Veneer EUR
	26	300	1	BN2306615.	773,80	910,20	1.274,60
	26	300	2	BN2306625.	1.734,80	2.040,80	2.857,20
	26	300	3	BN2306635.	2.893,50	3.403,90	4.765,50
	18	300	1	BN2306815.	773,80	910,20	1.274,60
	18	300	2	BN2306825.	1.577,30	1.855,70	2.597,90
	18	300	3	BN2306835.	2.314,70	2.723,10	3.812,30

WO5 - round double-sided wooden overlaying top plate - left outer

Particleboard. Incl. fittings.	Degree	Shelf depth mm	No. of bays	Item no.	Melamine EUR	Painted EUR	Veneer EUR
	26	300	1	BN2306611.	771,40	907,40	1.270,30
	26	300	2	BN2306621.	1.733,00	2.039,00	2.854,40
	26	300	3	BN2306631.	2.891,90	3.402,30	4.763,30
	18	300	1	BN2306811.	771,40	907,40	1.270,30
	18	300	2	BN2306821.	1.575,70	1.853,60	2.595,10
	18	300	3	BN2306831.	2.313,60	2.721,90	3.810,70

WO5 - round double-sided wooden overlaying top plate - intermediate

Particleboard. Incl. fittings.	Degree	Shelf depth mm	No. of bays	Item no.	Melamine EUR	Painted EUR	Veneer EUR
	26	300	1	BN2306613.	764,40	899,20	1.258,80
	26	300	2	BN2306623.	1.701,00	2.001,10	2.801,50
	26	300	3	BN2306633.	2.868,10	3.374,00	4.723,60
	18	300	1	BN2306813.	764,40	1.819,20	2.546,90
	18	300	2	BN2306823.	1.546,20	2.699,10	3.778,90
	18	300	3	BN2306833.	2.294,20	907,40	1.270,30

WO5 - round double-sided wooden overlaying top plate - right outer

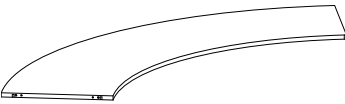
Particleboard. Incl. fittings.	Degree	Shelf depth mm	No. of bays	Item no.	Melamine EUR	Painted EUR	Veneer EUR
	26	300	1	BN2306612.	771,40	907,40	1.270,30
	26	300	2	BN2306622.	1.733,00	2.039,00	2.854,40
	26	300	3	BN2306632.	2.891,90	3.402,30	4.763,30
	18	300	1	BN2306812.	771,40	907,40	1.270,30
	18	300	2	BN2306822.	1.575,70	1.853,60	2.595,10
	18	300	3	BN2306832.	2.313,60	2.721,90	3.810,70

CASTORS

ROUND CASTOR FRAME & CASTOR PLATE



CASTORS

ROUND CASTOR FRAME & CASTORS

We recommend having a maximum of 3 adjoining bays mounted on castors.

Round castor frame set with visible castors

A set of 2 frames and 4 Ø75 mm castors. To be used with double-sided panels WP1, WP2, WP3, WP4 and back panels WPB1/WBP2. Max. height 1520 mm.

Degree	x castors with brake
26	0
26	2
18	0
18	2

Item no.	Price EUR
BN26060	364,80
BN26061	381,20
BN26080	364,80
BN26081	381,20

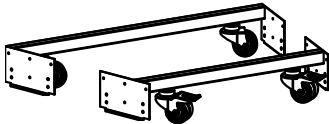

Castors for visible round castor frame set

Spare part. H112 mm, Ø75 mm. Max 90 kg. per castor.

Type

Item no.	Price EUR
----------	-----------

Without brake

B7860100	120,40
----------	--------

With brake

B7860101	145,80
----------	--------

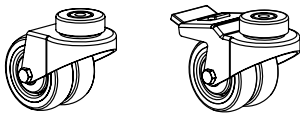

Round castor frame set with hidden castors and steel plinth

A set of 2 frames, 4 x Ø35 mm castors without brakes and 2 steel plinths. To be used with double-sided panels WP1, WP2, WP3, WP4 and back panels WPB1/WBP2. Max. height 1520 mm.

Degree

Item no.	Price EUR
----------	-----------

26

BN2616	558,10
--------	--------

18

BN2618	558,10
--------	--------

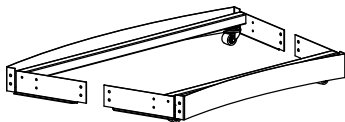

Castors for hidden round castor frame set

H50 mm, Ø35 mm. Spare part. Max. 100 kg per castor.

Type

Item no.	Price EUR
----------	-----------

Without brake

B301017	64,40
---------	-------

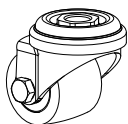

CASTORS

ROUND CASTOR PLATES

Painted and veneered castor plates are FSC-certified.

Double-sided round wooden castor plate

With 4/6/8 Ø75 mm castors, 2 of which are with brakes. To be used with double-sided panels WP5/WP7 for castor plate along with steel back panel SPB7/8 or steel back frame. Max. height 1520 mm.

Degree	Depth mm	No of bays	Item no.	Melamine EUR	Painted EUR	Veneer EUR
26	300	1	BN250661.	1.126,70	1.325,60	1.855,90
26	300	2	BN250662.	2.207,50	2.597,10	3.636,00
26	300	3	BN250663.	3.207,70	3.773,60	5.282,90
18	300	1	BN250681.	1.032,90	1.215,20	1.701,20
18	300	2	BN250682.	2.023,60	2.380,80	3.333,00
18	300	3	BN250683.	2.940,20	3.459,20	4.843,00

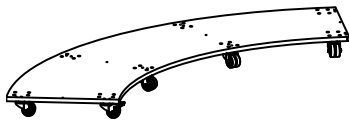

Castors for round castor plate

Spare part. H102 mm, Ø75 mm. Max 100 kg. per castor.

Type	Item no.	Price EUR
Without brake	B400001025	48,60
With brake	B400001125	59,10

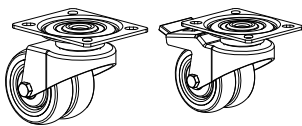

PLINTHS

ROUND STEEL PLINTHS

Painted and veneered plinths are FSC-certified.

Round steel plinth

Incl. screws. H71 mm. Cannot be used with castors.

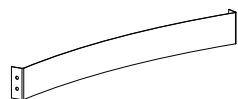

26 Inner
26 Outer

Item no.

BN22761
BN22762

Price
EUR

33,40
33,40

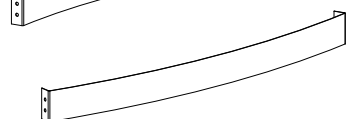

18 Inner
18 Outer

BN22781
BN22782

33,40
33,40

WOODEN PANELS

DOUBLE-SIDED - WITH ADJUSTABLE FEET - FOR WOODEN TOP SHELF

Painted and veneered panels are FSC-certified.

WP1 - double-sided outer end panel with adjustable feet - for WT5

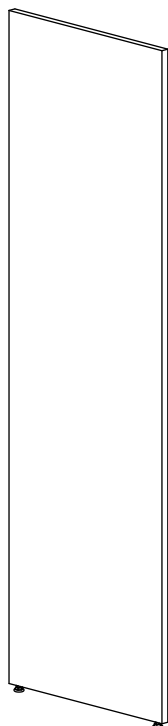

Height mm	Shelf depth mm	Item no.	Melamine EUR	Painted EUR	Veneer EUR
720	300	BN0014265.	244,60	287,60	421,30
920	300	BN0014365.	312,60	367,90	515,10
1220	300	BN0014465.	406,20	477,80	669,40
1520	300	BN0014565.	427,90	503,40	705,20
1820	300	BN0014665.	505,50	595,00	832,80
2120	300	BN0014765.	580,50	683,10	956,30

WP1 - double-sided intermediate panel with adjustable feet - for WT5

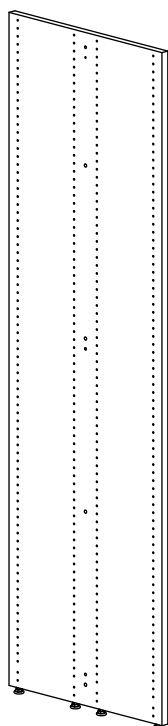

Height mm	Shelf depth mm	Item no.	Melamine EUR	Painted EUR	Veneer EUR
720	300	BN0014264.	244,60	287,60	402,90
920	300	BN0014364.	312,60	367,90	515,10
1220	300	BN0014464.	406,20	477,80	669,40
1520	300	BN0014564.	427,90	503,40	705,20
1820	300	BN0014664.	505,50	595,00	832,80
2120	300	BN0014764.	580,50	683,10	956,30

WOODEN PANELS

DOUBLE-SIDED - WITH ADJUSTABLE FEET - FOR STEEL AND WOODEN TOP SHELF

Painted and veneered panels are FSC-certified.

WP2 - double-sided slat outer end panel with milled slat - with adjustable feet - for ST1/ST2/ST3 and WT1

H1520 has 2 slats, H1820 and 2120 has 3 slats.

Height
mm

Shelf depth
mm

Item no.

Melamine

Painted

Veneer

1520

300

BN0455651.

-

754,10

1.055,40

1820

300

BN0456651.

-

861,50

1.206,20

2120

300

BN0457651.

-

989,70

1.385,40

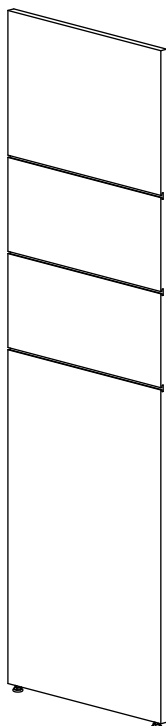

WOODEN PANELS

DOUBLE-SIDED - WITH ADJUSTABLE FEET & OVERLAYING TOP PLATE

Painted and veneered panels are FSC-certified.

WP3 - double-sided outer end panel with adjustable feet - for WO5

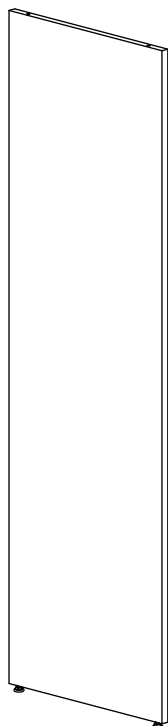

Height mm	Shelf depth mm	Item no.	Melamine EUR	Painted EUR	Veneer EUR
720	300	BN0014269.	244,60	287,60	402,90
920	300	BN0014369.	312,60	367,90	515,10
1220	300	BN0014469.	406,20	477,80	669,40
1520	300	BN0014569.	427,90	503,40	705,20
1820	300	BN0014669.	505,50	595,00	832,80
2120	300	BN0014769.	580,50	683,10	956,30

WP3 - double-sided intermediate panel with adjustable feet - for WO5

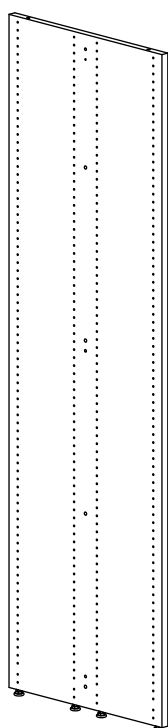

Height mm	Shelf depth mm	Item no.	Melamine EUR	Painted EUR	Veneer EUR
720	300	BN0014268.	244,60	287,60	402,90
920	300	BN0014368.	312,60	367,90	515,10
1220	300	BN0014468.	406,20	477,80	669,40
1520	300	BN0014568.	427,90	503,40	705,20
1820	300	BN0014668.	505,50	595,00	832,80
2120	300	BN0014768.	580,50	683,10	956,30

WOODEN PANELS

DOUBLE-SIDED - WITH ADJUSTABLE FEET & OVERLAYING TOP PLATE

Painted and veneered panels are FSC-certified.

WP4 - double-sided slat outer end panel with milled slat and adjustable feet - for WO1

H1520 has 2 slats, H1820 and 2120 has 3 slats.

Height
mm

Shelf depth
mm

Item no.

Melamine

Painted

Veneer

1520

300

BN0455691.

-

754,10

1.055,40

1820

300

BN0456691.

-

861,50

1.206,20

2120

300

BN0457691.

-

989,70

1.385,40

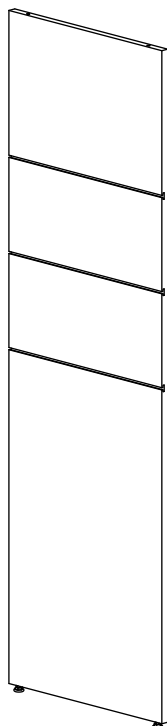

WOODEN PANELS

DOUBLE-SIDED - FOR CASTOR PLATE & WOODEN TOP SHELF

Painted and veneered panels are FSC-certified.

WP5 - double-sided outer end panel for castor plate - for WT5

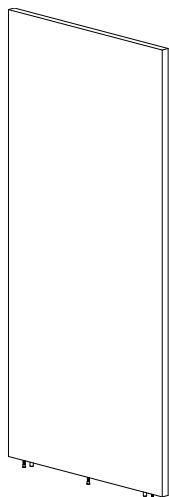

Height mm	Shelf depth mm	Item no.	Melamine EUR	Painted EUR	Veneer EUR
720	300	BN0015265.	244,60	287,60	402,90
920	300	BN0015365.	312,60	367,90	515,10
1220	300	BN0015465.	406,20	477,80	669,40
1520	300	BN0015565.	427,90	503,40	705,20

WP5 - double-sided intermediate panel for castor plate - for WT5

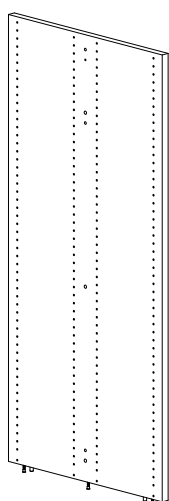

Height mm	Shelf depth mm	Item no.	Melamine EUR	Painted EUR	Veneer EUR
720	300	BN0015264.	244,60	287,60	402,90
920	300	BN0015364.	312,60	367,90	515,10
1220	300	BN0015464.	406,20	477,80	669,40
1520	300	BN0015564.	427,90	503,40	705,20

WOODEN PANELS

DOUBLE-SIDED - FOR CASTOR PLATE & TOP SHELF

Painted and veneered panels are FSC-certified.

WP6 - double-sided slat outer end panel with milled slats - for castor plate - for ST1/ST2/ST3 and WT1

H1520 has 2 slats.

Height
mm

Shelf depth
mm

Item no.

Melamine

Painted

Veneer

1520

300

BN0465651.

-

754,10

1.055,40

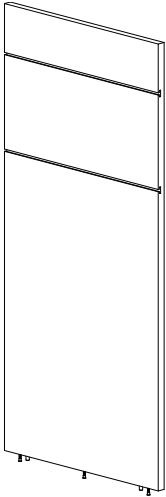

WOODEN PANELS

DOUBLE-SIDED - FOR CASTOR PLATE & OVERLAYING TOP PLATE

Painted and veneered panels are FSC-certified.

WP7 - double-sided outer end panel for castor plate - for WO5

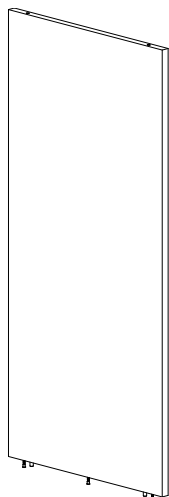

Height mm	Shelf depth mm	Item no.	Melamine EUR	Painted EUR	Veneer EUR
720	300	BN0015269.	244,60	287,60	402,90
920	300	BN0015369.	312,60	367,90	515,10
1220	300	BN0015469.	406,20	477,80	669,40
1520	300	BN0015569.	427,90	503,40	705,20

WP7 - double-sided intermediate panel for castor plate - for WO5

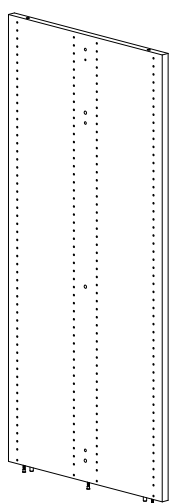

Height mm	Shelf depth mm	Item no.	Melamine EUR	Painted EUR	Veneer EUR
720	300	BN0015268.	244,60	287,60	402,90
920	300	BN0015368.	312,60	367,90	515,10
1220	300	BN0015468.	406,20	477,80	669,40
1520	300	BN0015568.	427,90	503,40	705,20

WOODEN PANELS

DOUBLE-SIDED - FOR CASTOR PLATE & OVERLAYING TOP PLATE

Painted and veneered panels are FSC-certified.

WP8 - double-sided slat outer end panel with milled slat - for castor plate - for WO1

H1520 has 2 slats.

Height
mm

Shelf depth
mm

Item no.

Melamine

Painted

1520

300

BN0465691.

-

754,10

1.055,40

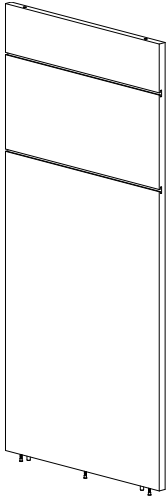

WOODEN PANELS

WOODEN END PANEL BAYS

Use the panel to create a display area on Lingo shelving system. The end panel bay is easily retrofitted on existing double-sided shelving systems with adjustable feet/castor frame (replace existing end panel with end panel bay). Painted and veneered panels are FSC-certified.

Wooden end panel bay - for bays with top shelf

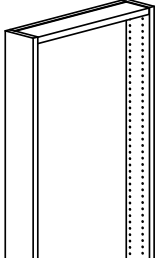
Fastening material included.	Height mm	Shelf depth mm	Width mm	Item no.	Melamine EUR	Painted EUR	Veneer EUR
	720	300	598	BN5402B1.	1.055,60	1.303,90	1.825,60
	920	300	598	BN5403B1.	1.329,90	1.564,60	2.190,80
	1220	300	598	BN5404B1.	1.596,00	1.877,80	2.628,70
	1520	300	598	BN5405B1.	1.835,60	2.159,40	3.023,10
	1820	300	598	BN5406B1.	2.110,70	2.483,20	3.476,40
	2120	300	598	BN5407B1.	2.216,40	2.607,60	3.650,50

Wooden end panel bay - for bays with overlaying top plate

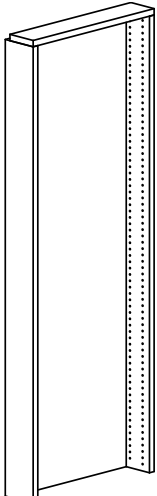
Fastening material included.	Height mm	Shelf depth mm	Width mm	Item no.	Melamine EUR	Painted EUR	Veneer EUR
	720	300	598	BN5402B2.	1.108,30	1.303,90	1.825,60
	920	300	598	BN5403B2.	1.329,90	1.564,60	2.190,80
	1220	300	598	BN5404B2.	1.596,00	1.877,80	2.628,70
	1520	300	598	BN5405B2.	1.835,60	2.159,40	3.023,10
	1820	300	598	BN5406B2.	2.110,70	2.483,20	3.476,40
	2120	300	598	BN5407B2.	2.216,40	2.607,60	3.650,50

WOODEN PANELS

WOODEN END PANEL BAYS

The functions below are suited for hanging on wooden end panel bays. Painted and veneered products are FSC-certified.

Wooden sign for wooden end panel bay

H368 mm. Incl. fittings.	Width mm	Shelf depth mm	Item no.	Melamine EUR	Painted EUR	Veneer EUR
	598	300	BN541B.	264,60	311,10	435,90

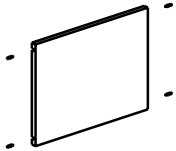

Steel display shelf for wooden end panel bay

H280 mm. Incl. fittings.	Width mm	Shelf depth mm	Item no.	Steel EUR
	598	300	BN542B	128,30

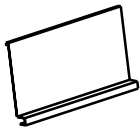

Wooden brochure rack for wooden end panel bay

H140 mm. Front and three adjustable dividers in acrylic glass. Incl. fittings.	Width mm	Shelf depth mm	Item no.	Melamine EUR	Painted EUR	Veneer EUR
	598	300	BN543B.	534,00	628,20	879,30

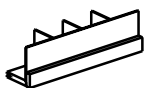

CONNECTION ELEMENTS

ROUND STEEL BACK PANELS - FOR ADJUSTABLE FEET

SBP5 - high steel back panel - for WT5/WT7 (standard depth)/WO5

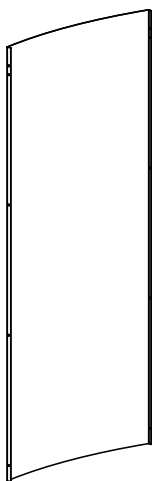

Degree	Height mm	Item no.	Price EUR
26	720	BN219264	200,50
26	920	BN219364	256,10
26	1220	BN219464	339,70
26	1520	BN219564	423,10
26	1820	BN219664	506,60
26	2120	BN219764	590,00
18	720	BN219284	200,50
18	920	BN219384	256,10
18	1220	BN219484	339,70
18	1520	BN219584	423,10
18	1820	BN219684	506,60
18	2120	BN219784	590,00

SBP6 - low steel back panel - for WT5/WT7 (double-sided)

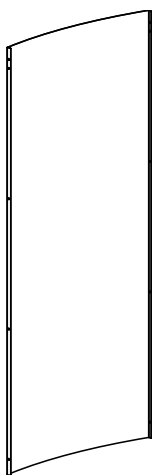

Degree	Height mm	Item no.	Price EUR
26	720	BN219266	200,50
26	920	BN219366	256,10
26	1220	BN219466	339,70
26	1520	BN219566	423,10
26	1820	BN219666	506,60
26	2120	BN219766	590,00
18	720	BN219286	200,50
18	920	BN219386	256,10
18	1220	BN219486	339,70
18	1520	BN219586	423,10
18	1820	BN219686	506,60
18	2120	BN219786	590,00

CONNECTION ELEMENTS

ROUND STEEL BACK PANELS - FOR CASTOR PLATE

SBP7 - high steel back panel - for WT5/WT7 (standard depth)/WO5

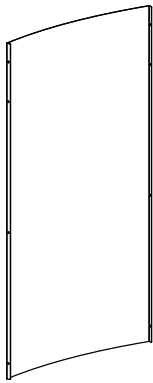

Degree	Height mm	Item no.	Price EUR
26	720	BN220264	200,50
26	920	BN220364	256,10
26	1220	BN220464	339,70
26	1520	BN220564	423,10
18	720	BN220284	200,50
18	920	BN220384	256,10
18	1220	BN220484	339,70
18	1520	BN220584	423,10

SBP8 - low steel back panel - for WT5/WT7 (double-sided)

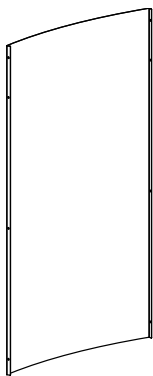

Degree	Height mm	Item no.	Price EUR
26	720	BN220266	200,50
26	920	BN220366	256,10
26	1220	BN220466	339,70
26	1520	BN220566	423,10
18	720	BN220286	200,50
18	920	BN220386	256,10
18	1220	BN220486	339,70
18	1520	BN220586	423,10

CONNECTION ELEMENTS

ROUND STEEL BACK FRAME

To ensure correct stability, double-sided shelvings H1820 mm and H2120 mm with back frame must have an additional steel back frames installed depending on number of bays. Configurations for freestanding bays include one additional back frame. Back frame for intermediate bays must be ordered separately, see overview page 11.

Round steel back frame

With fittings.

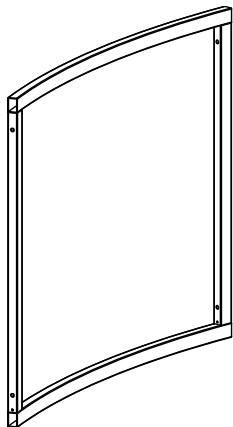

Degree	Bay	Item no.	Price EUR
26	Freestanding	BN21064ZZZ8	267,20
26	Intermediate	BN21064ZZZ9	267,20
18	Freestanding	BN21084ZZZ8	267,20
18	Intermediate	BN21084ZZZ9	267,20



LOCATIONS

WE ARE LIBRARY PEOPLE®

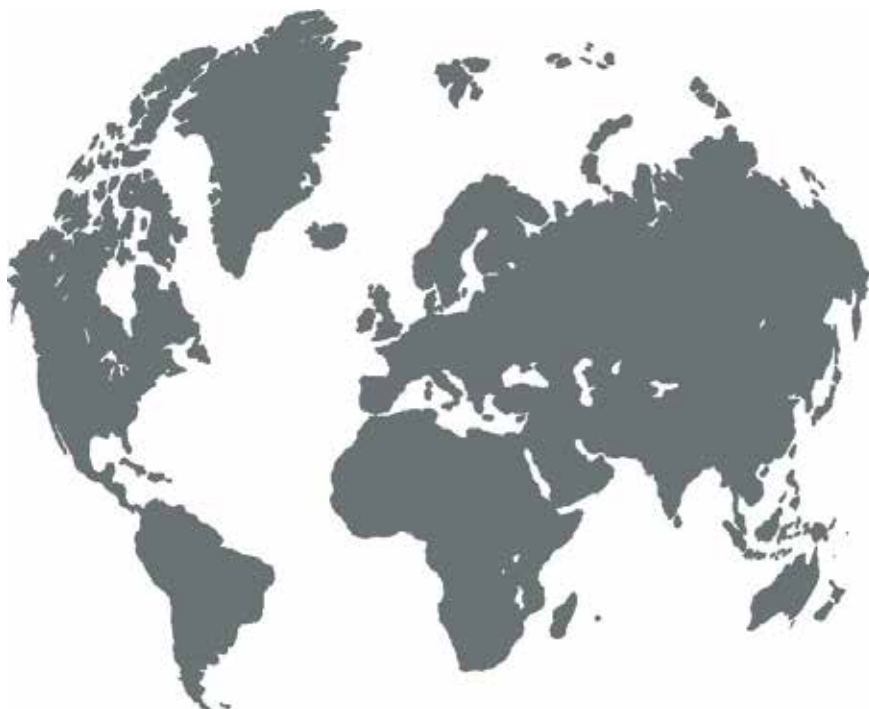

DENMARK

Lammhults Biblioteksdesign A/S
Dalbækvej 1
6670 Holsted

bci@bci.dk
www.bci.dk

SWEDEN

Lammhults Biblioteksdesign AB
Odlarevägen 16
226 60 Lund

eurobib@eurobib.se
www.eurobib.se

UNITED KINGDOM

thedesignconcept Ltd.
The Old Bakery,
10 Greenless Road
Cambuslang Belgrave Street
Glasgow G72 8JJ

info@thedesignconcept.co.uk
www.thedesignconcept.co.uk

FRANCE

BC Intérieur Sarl
6 allée Kepler
77420 Champs sur Marne

bci@bcinterieur.com
www.bcinterieur.com

GERMANY

Schulz Speyer Bibliothekstechnik AG
Hafenstraße 2
67346 Speyer

sales@schulzspeyer.de
www.schulzspeyer.de

NORWAY

BS Eurobib AS
Alf Bjerckes Vei 20
0582 Oslo

post@bseurobib.no
www.bseurobib.no

BELGIUM

SBNL - Schulz Benelux BVBA
Appelweg 94 C
3221 Holsbeek

info@sbnl.be
www.sbnl.be