



# CONCERTINA

01.01.2022



# CONCERTINA COUNTER

Concertina is an adjustable and ergonomic work station. The counter takes the comfort of the user into account and improves the work habit of library and office employees. The height adjustability gives the user the flexibility to change work postures during the course of the day to break potentially health-impairing routines or to adjust the work station to fit several individuals or tasks simultaneously.

The counter is often placed at the entrance area and is the first point of contact, thus the first impression of the library. Therefore, the counter should be welcoming, inviting and tempt people to enter and explore the library.

With its aesthetic and functional design the Concertina counter offers a flexible system with a range of options to fit the individual needs.



**DESIGN OPTIONS**..... 4

**TECHNICAL SPECIFICATIONS**..... 6

## **CONFIGURATIONS**

**CONCERTINA COUNTER**..... 9

Configuration ..... 11

## **COMPONENTS**

### **BASE MODULES**

Straight base module - steel front panel ..... 12

Curved base module - steel front panel ..... 13

### **INTERMEDIATE MODULES**

Intermediate module ..... 14

### **COUNTER TOPS**

Counter top for straight base module ..... 15

Counter top for 45° curved base module ..... 16

Counter top for 60° curved base module ..... 17

### **ACCESSORIES**

Accessories ..... 19

# DESIGN OPTIONS

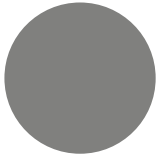

The Concertina counter is delivered as standard in Concertina grey (A29) and all prices in this price list are based on this.

Please see specifications below for the various parts on a Concertina counter:

## LOWER FRONT PANEL (1)

The lower front panel is made of steel and delivered as standard in Concertina grey (A29).

## UPPER FRONT PANEL (2)

The upper front panel is made of steel and delivered as standard in Concertina grey (A29) and can be ordered in other colours - see page 5.

## END FRAMES (3)

The end frames are made of steel and delivered as standard in Concertina grey (A29).

## ACTUATOR (4)

The actuator is only available in White Aluminium (A14).

## RUBBER EDGING (5) AND BUMPERS (6)

The rubber edging and bumpers are delivered as standard in grey, but are available in black at no surcharge.

## STEEL PART ON COUNTER TOPS (7)

The steel parts on the counter tops are delivered as standard in Concertina grey (A29).

## COUNTER TOPS (8) AND BAG SHELVES (9)

The counter tops and bag shelves are as standard produced in grey laminate "Dandekor Etronit MB 311 NCS 4502-B Grey" (#185) or grey linoleum "Forbo desktop elegance 4175 Grey" (#257). Some special laminates and linoleums may release a surcharge.

## DRAWER PEDESTALS (10)

The drawer pedestals are as standard produced in Concertina grey (A29). The drawer pedestals can be painted in any NCS or RAL colour without extra surcharge.

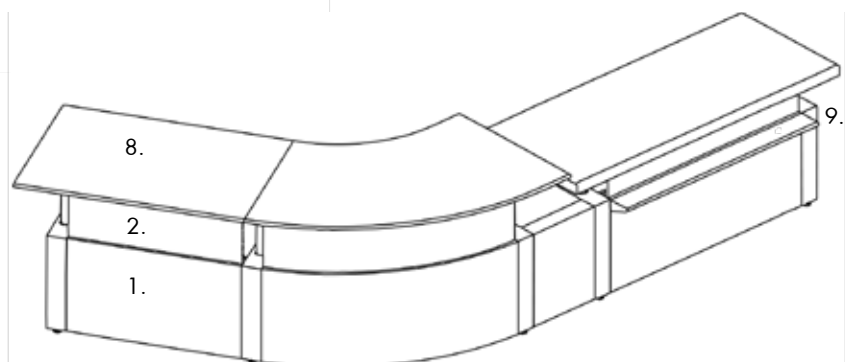
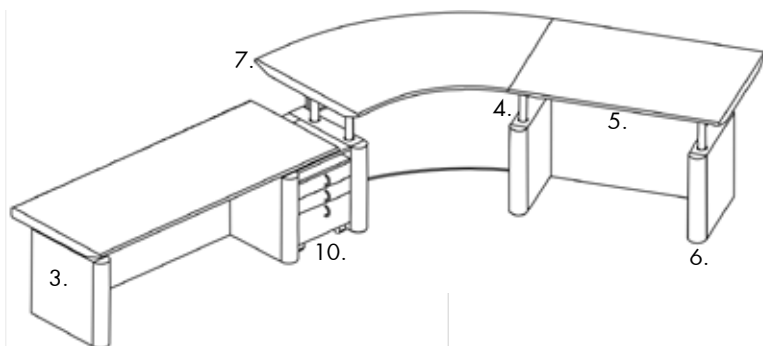

# DESIGN OPTIONS

STEEL COMPONENTS - PAINTED

## A PRICE GROUP - BASIS PRICE (smooth finish)



**A03**  
**Traffic white**  
RAL 9016  
Gloss 75-90



**A02**  
**Oyster white**  
RAL 1013  
Gloss 40-50

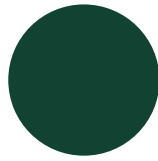

**A22**  
**Moss green**  
RAL 6005  
Gloss 71-85



**A26**  
**Fir green**  
RAL 6009  
Gloss 71-85

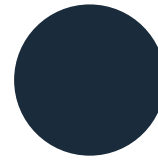

**A12**  
**Steel blue**  
RAL 5011  
Gloss 71-85

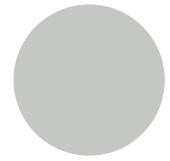

**A13**  
**Light grey**  
RAL 7035  
Gloss 71-85

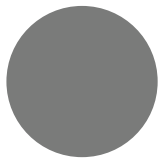

**A15**  
**Dusty grey**  
RAL 7037  
Gloss 71-85

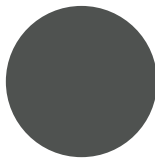

**A16**  
**Traffic grey**  
RAL 7043  
Gloss 71-85

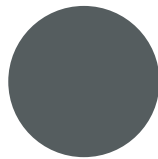

**A17**  
**Basalt grey**  
RAL 7012  
Gloss 71-85

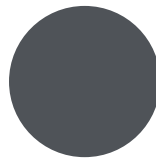

**A18**  
**Slate grey**  
RAL 7015  
Gloss 71-85

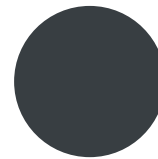

**A19**  
**Anthracite grey**  
RAL 7016  
Gloss 71-85

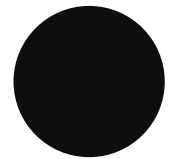

**A25**  
**Jet black**  
RAL 9005  
Gloss 71-85

## B PRICE GROUP - BASIS PRICE WITH 7% SURCHARGE (smooth finish)



**A01**  
**Pure white**  
RAL 9010  
Gloss 71-85

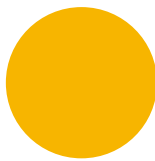

**A04**  
**Traffic yellow**  
RAL 1023  
Gloss 71-85

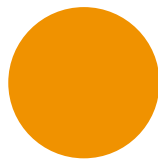

**A05**  
**Sun yellow**  
RAL 1037  
Gloss 71-85

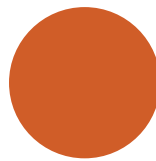

**A06**  
**Signal orange**  
RAL 2010  
Gloss 71-85

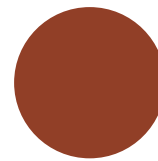

**A07**  
**Pearl orange**  
RAL 2013  
Gloss 65-85

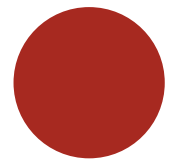

**A08**  
**Flame red**  
RAL 3000  
Gloss 71-85

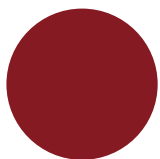

**A09**  
**Ruby red**  
RAL 3003  
Gloss 71-85

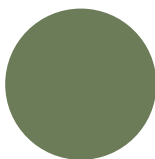

**A21**  
**Reseda green**  
RAL 6011  
Gloss 71-85

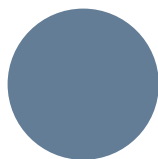

**A10**  
**Pigeon blue**  
RAL 5014  
Gloss 71-85

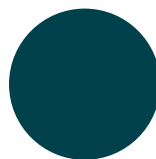

**A11**  
**Ocean blue**  
RAL 5020  
Gloss 71-85

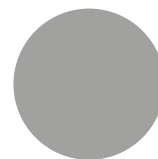

**A14**  
**White aluminium**  
RAL 9006  
Gloss 50-70

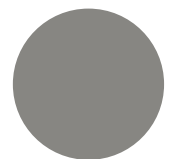

**A31**  
**Grey aluminium**  
RAL 9007  
Gloss 50-70

## B PRICE GROUP - BASIS PRICE WITH 7% SURCHARGE (textured finish)



**A27**  
**Pure white**  
RAL 9010

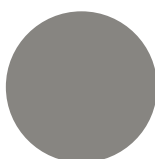

**A28**  
**Grey aluminium**  
RAL 9007



**A23**  
**Anthracite grey**  
RAL 7016



**A24**  
**Graphite black**  
RAL 9011

# TECHNICAL SPECIFICATIONS

## GENERAL SPECIFICATIONS

### CONSTRUCTION

The construction of the Concertina counter with more than one module is based on a left-to-right sequence (seen from the person's view sitting behind the counter).

### BASE MODULES

The base module has a lower dual front panel, a cable carrier, an upper front panel and two end frames. The end frames are fitted with a rubberized half round PVC bumper in medium grey placed on the user side and supplied with two actuators.

The base modules are available as:

- Two optional widths (1100 or 1500 mm)
- Straight and curved modules (45° or 60°)
- Fixed height (standard 720 mm) or electronically adjustable (700 - 1200 mm)
- Freestanding or connected modules (starter and add-on)
- Front panel in steel
- Upper front panel in solid steel or perforated steel

### UPPER FRONT PANELS

The upper front panel has either a solid steel or steel perforated surface. It is fastened underneath the counter top and follows the counter top up and down.

### COUNTER TOPS

The counter tops are supplied with solid, grey, flexible, rubberized PVC edges. The counter tops are available as:

- Three optional depths (660, 780 or 900 mm)
- Four optional functions (freestanding, left side free, middle, right side free)
- Optional widths depending on base module width:
  - 1100 mm base = 1100, 1300 or 1500 mm
  - 1500 mm base = 1500, 1700 or 1900 mm
- Four designs (no projection, projection towards client, projection towards user, projection both sides)

### INTERMEDIATE MODULES

The intermediate module includes a dual front panel, cable carrier and a top shelf. It is used to connect modules that do not have connecting counter tops.

### ELECTRICAL WIRE TRANSFER

All end frames have a rectangular electrical wire transfer knock out on the right hand side of the end frame (when viewed from the user's side). Configurations of successive modules are prepared for wire-lead through in the end frames. The cable carrier is placed between the dual front panels on the base module, supporting any wire electrical components.

# TECHNICAL SPECIFICATIONS

## STEEL COMPONENTS

### **STEEL COMPONENTS**

are powder coated with standard polyester based powders that secures high UV resistance. Powders comply with EN 45545 (fire protection - similar to DIN 4201). Thickness of the coating is 60-80 my.

The powder used includes:

- no triglycidylisocyanurate (TGIC)
- no heavy metal-containing pigments such as lead and cadmium
- no volatiles

Antibacterial equipping of surfaces upon request.



**Morsø Public Library, Denmark**  
Two Concertina 45° curved base modules with counter tops



# CONCERTINA COUNTER

## DIMENSIONS

The modules for a Concertina counter vary in size. Please find important dimensions below.

### HEIGHT

The Concertina counter is available in two models - fixed height (standard 720 mm) or adjustable height. Fixed height counters can be ordered in the range from 700-1200 mm.

### DEPTH

The straight and curved counter tops are available in three depths:

660 mm  
780 mm  
900 mm

### WIDTH

The straight base modules are available in two widths:  
1100 mm  
1500 mm

The straight and curved counter tops are available in four widths, depending on type of module (straight/curved), counter top depth (660/780/900 mm) and curve (45°/60°):

1300 mm  
1500 mm  
1700 mm  
1900 mm

See below for further specifications.

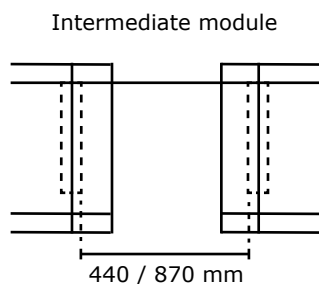
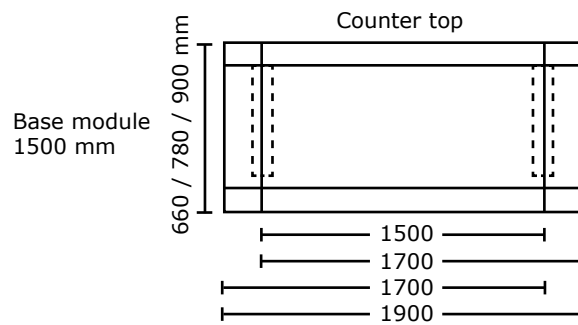
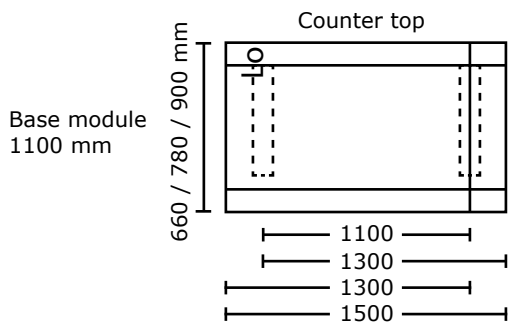

### Curved modules

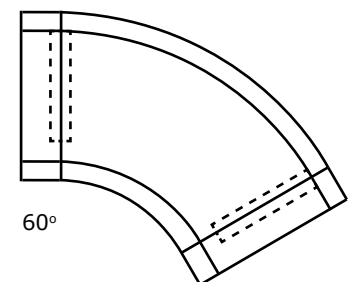
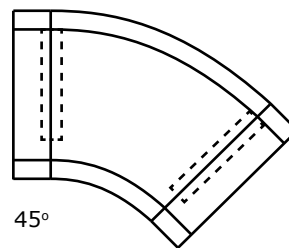

### CONFIGURATION OF COUNTER TOPS

Base module	Width mm counter top
1100 mm	1100 mm counter top is used when connecting modules are placed on either side
1100 mm	1300 mm counter top is used when an adjacent module is placed on one side
1100 mm	1500 mm counter top is used for a freestanding module
1500 mm	1500 mm counter top is used when connecting modules are placed on either side
1500 mm	1700 mm counter top is used when an adjacent module is placed on one side
1500 mm	1900 mm counter top is used for a freestanding module



# CONCERTINA COUNTER

## CONFIGURATION

Below you will find a price example of a Concertina counter:

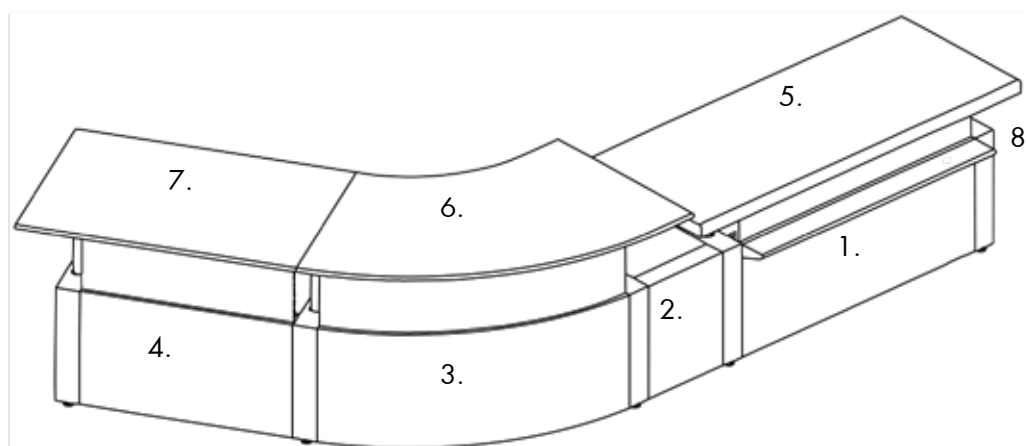
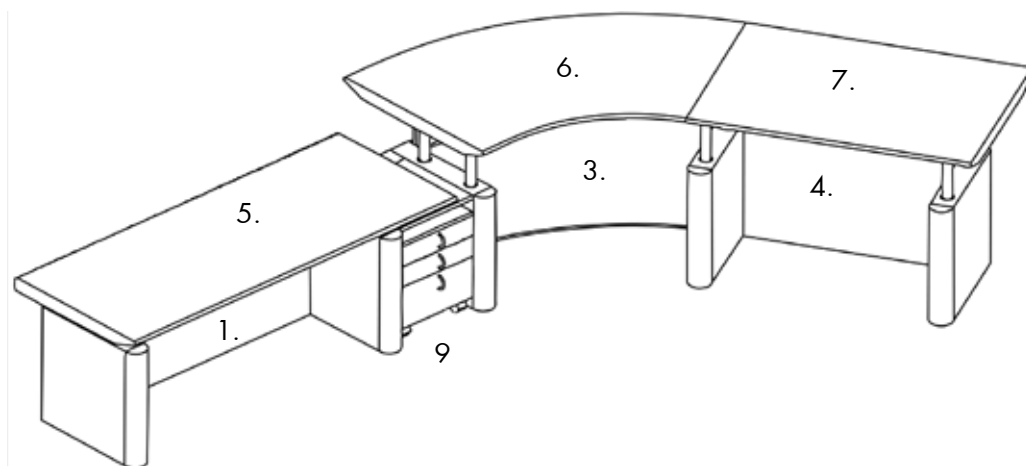

NO.	DESCRIPTION	ITEM NO.
1.	Straight start base module with steel front panel and steel upper panel. W1500 mm. Fixed height 700 mm.	B36000107015340
2.	Intermediate module. W440 mm.	B360009703
3.	60° curved base module with steel front panel and steel upper panel. Electronically adjustable height.	B36000100060340
4.	Straight add-on base module with steel front panel and steel upper panel. W1100 mm. Electronically adjustable height.	B36000200011340
5.	Starter freestanding straight counter top with projection towards staff. D780 mm x W1900 mm.	B36002119380
6.	Starter left side free 60° curved counter top with projection on both sides. D900 mm.	B36002160470
7.	Add-on right side free straight counter top with projection on both sides. D900 mm x W1300 mm.	B36002113460
8.	Bag shelf. W1500 mm.	B360010153
9.	Drawer pedestal with lock, castors and 3 drawers.	B36600431
	Total	

### DESIGN OPTIONS:

Base module:	BCI standard colour no. A29 Concertina grey texture*
Upper front panel:	BCI standard steel colours (for colours, see page 5)
Counter top:	BCI standard laminate #185 or linoleum #257
Drawer pedestal:	BCI standard colour no. A29 Concertina grey (for colours, see page 7)

\*Other colours can be ordered at a surcharge per module of EUR 135.

# CONCERTINA COUNTER

## STRAIGHT BASE MODULES WITHOUT COUNTER TOPS - STEEL FRONT PANEL

A straight module with steel front panel and steel/perforated steel upper panel. When ordering an adjustable base module, it is necessary to mention whether it is a freestanding desk or whether it is followed by one or two add-ons.

### Straight base module - with steel front panel and steel upper panel

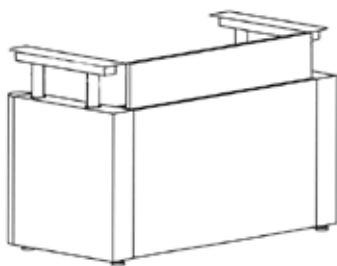

Width mm	Fixed/ Adjustable	Starter module Item no.	Add-on module Item no.
1100	Fixed	B36000107211340	B36000207211340
1100	Adjustable	B36000100011340	B36000200011340
1500	Fixed	B36000107215340	B36000207215340
1500	Adjustable	B36000100015340	B36000200015340

### Straight base module - with steel front panel and perforated steel upper panel

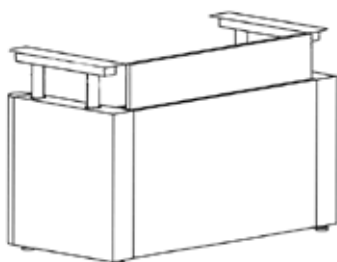

Module mm	Fixed/ Adjustable	Starter module Item no.	Add-on module Item no.
1100	Fixed	B36000107211350	B36000207211350
1100	Adjustable	B36000100011350	B36000200011350
1500	Fixed	B36000107215350	B36000207215350
1500	Adjustable	B36000100015350	B36000200015350

# CONCERTINA COUNTER

## CURVED BASE MODULES WITHOUT COUNTER TOPS - STEEL FRONT PANEL

A curved module with steel front panel and steel/perforated steel upper panel. When ordering an adjustable base module, it is necessary to mention whether it is a freestanding desk or whether it is followed by one or two add-ons. We do not recommend using 45° counters as freestanding due to minimal legroom between the end frames.

---

### Curved base module - with steel front panel and steel upper panel

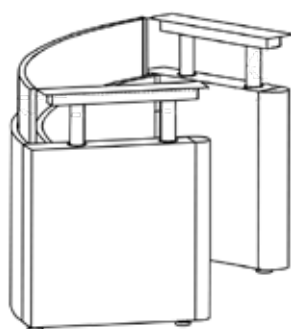

Curve	Fixed/ Adjustable	Starter module Item no.	Add-on module Item no.
45°	Fixed	B36000107245340	B36000207245340
45°	Adjustable	B36000100045340	B36000200045340
60°	Fixed	B36000107260340	B36000207260340
60°	Adjustable	B36000100060340	B36000200060340

---

### Curved base module - with steel front panel and perforated steel upper panel

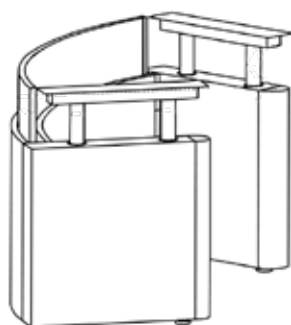

Curve	Fixed/ Adjustable	Starter module Item no.	Add-on module Item no.
45°	Fixed	B36000107245350	B36000207245350
45°	Adjustable	B36000100045350	B36000200045350
60°	Fixed	B36000107260350	B36000207260350
60°	Adjustable	B36000100060350	B36000200060350

# CONCERTINA COUNTER

## INTERMEDIATE MODULE - STEEL FRONT PANEL

The intermediate module is used when the counter top is wider than the base.

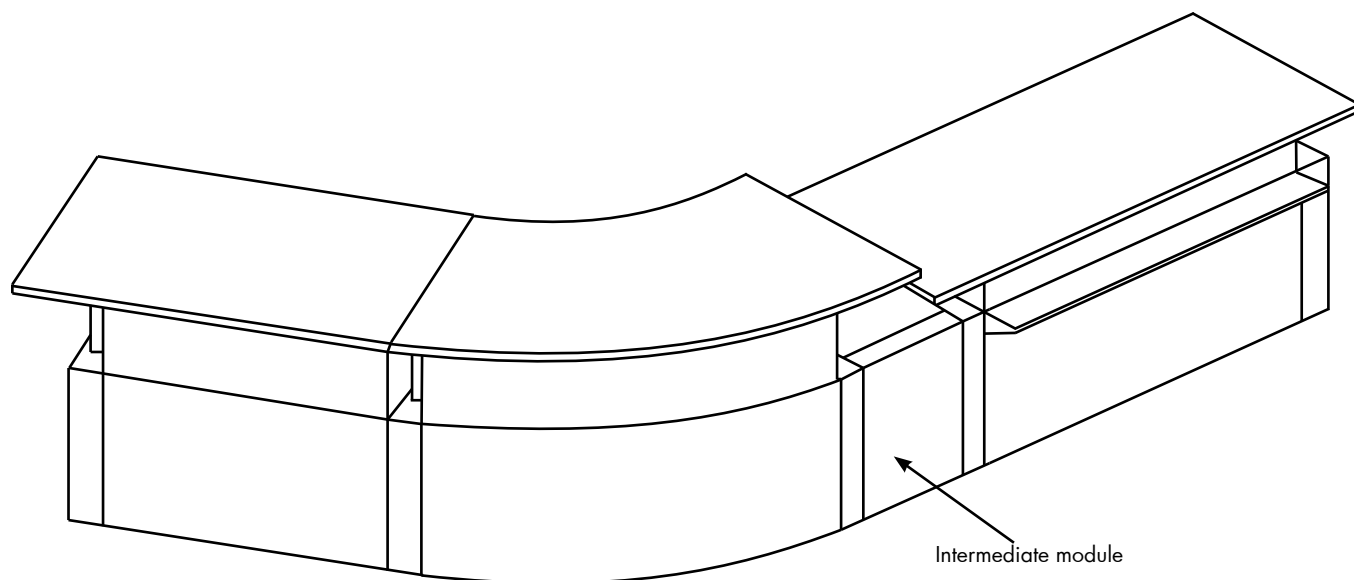

### Intermediate module - with steel front panel

Width  
mm

Item no.

440

B360009703

870

B360009873

# CONCERTINA COUNTER

## COUNTER TOPS FOR STRAIGHT BASE MODULE

The counter tops are available in four models; no projection, projection towards client, projection towards staff, and projection on both sides. Furthermore the counter tops are prepared for either freestanding, left side free, middle and right side free modules all depending on the position of the module. Note the construction of the Concertina counter is based on a left-to-right sequence (seen from the person's view sitting behind the counter).

### No projection - depth 660 mm - for straight base module

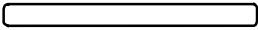
	Model	Width mm	Item no.
	Freestanding	1500	B36002115180
	Freestanding	1900	B36002119180
	Right side free	1300	B36002113160
	Right side free	1700	B36002117160
	Middle	1100	B36002111150
	Middle	1500	B36002115150
	Left side free	1300	B36002113170
	Left side free	1700	B36002117170

### Projection towards client - depth 780 mm - for straight base module

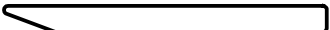
	Model	Width mm	Item no.
	Freestanding	1500	B36002115280
	Freestanding	1900	B36002119280
	Right side free	1300	B36002113260
	Right side free	1700	B36002117260
	Middle	1100	B36002111250
	Middle	1500	B36002115250
	Left side free	1300	B36002113270
	Left side free	1700	B36002117270

### Projection towards staff - depth 780 mm - for straight base module

	Model	Width mm	Item no.
	Freestanding	1500	B36002115380
	Freestanding	1900	B36002119380
	Right side free	1300	B36002113360
	Right side free	1700	B36002117360
	Middle	1100	B36002111350
	Middle	1500	B36002115350
	Left side free	1300	B36002113370
	Left side free	1700	B36002117370

### Projection on both sides - depth 900 mm - for straight base module

	Model	Width mm	Item no.
	Freestanding	1500	B36002115480
	Freestanding	1900	B36002119480
	Right side free	1300	B36002113460
	Right side free	1700	B36002117460
	Middle	1100	B36002111450
	Middle	1500	B36002115450
	Left side free	1300	B36002113470
	Left side free	1700	B36002117470

# CONCERTINA COUNTER

## COUNTER TOPS FOR 45° CURVED BASE MODULE

The counter tops are available in four models; no projection, projection towards client, projection towards staff, and projection on both sides. Furthermore the counter tops are prepared for either freestanding, left side free, middle and right side free modules all depending on the position of the module. Note the construction of the Concertina counter is based on a left-to-right sequence (seen from the person's view sitting behind the counter).

---

### No projection - depth 660 mm - for 45° curved base module

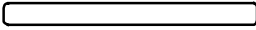
	Model	Item no.
	Freestanding	
	Right side free	B36002145160
	Middle	B36002145150
	Left side free	B36002145170

---

### Projection towards client - depth 780 mm - for 45° curved base module

	Model	Item no.
	Freestanding	
	Right side free	B36002145260
	Middle	B36002145250
	Left side free	B36002145270

---

### Projection towards staff - depth 780 mm - for 45° curved base module

	Model	Item no.
	Freestanding	
	Right side free	B36002145360
	Middle	B36002145350
	Left side free	B36002145370

---

### Projection on both sides - depth 900 mm - for 45° curved base module

	Model	Item no.
	Freestanding	
	Right side free	B36002145460
	Middle	B36002145450
	Left side free	B36002145470



# CONCERTINA COUNTER

## COUNTER TOPS FOR 60° CURVED BASE MODULE

The counter tops are available in four models; no projection, projection towards client, projection towards staff, and projection on both sides. Furthermore the counter tops are prepared for either freestanding, left side free, middle and right side free modules all depending on the position of the module. Note the construction of the Concertina counter is based on a left-to-right sequence (seen from the person's view sitting behind the counter).

---

### No projection - depth 660 mm - for 60° curved base module

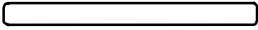
	Model	Item no.
	Freestanding	B36002160180
	Right side free	B36002160160
	Middle	B36002160150
	Left side free	B36002160170

---

### Projection towards client - depth 780 mm - for 60° curved base module

	Model	Item no.
	Freestanding	B36002160280
	Right side free	B36002160260
	Middle	B36002160250
	Left side free	B36002160270

---

### Projection towards staff - depth 780 mm - for 60° curved base module

	Model	Item no.
	Freestanding	B36002160380
	Right side free	B36002160360
	Middle	B36002160350
	Left side free	B36002160370

---

### Projection on both sides - depth 900 mm - for 60° curved base module

	Model	Item no.
	Freestanding	B36002160480
	Right side free	B36002160460
	Middle	B36002160450
	Left side free	B36002160470

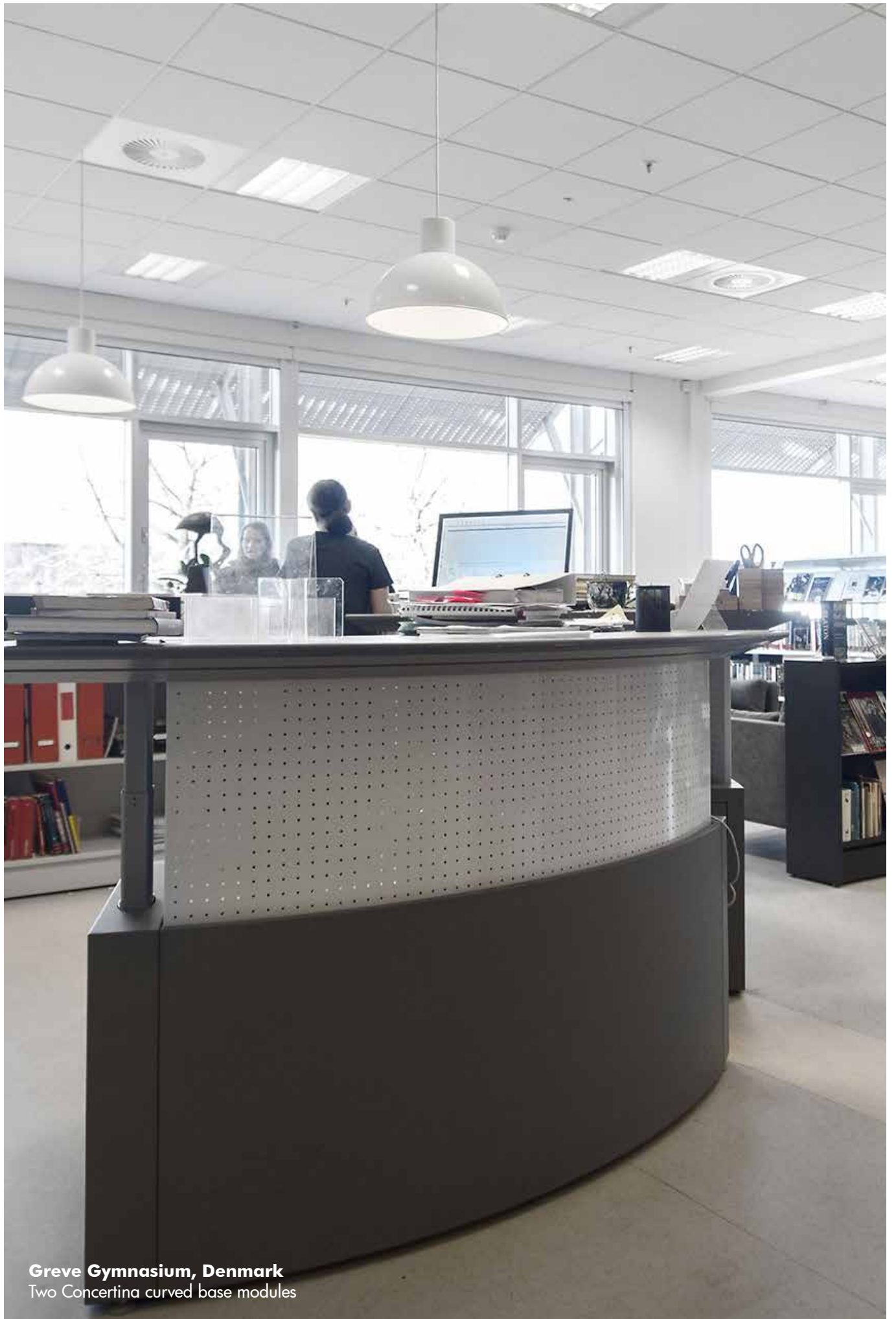

**Greve Gymnasium, Denmark**  
Two Concertina curved base modules

# CONCERTINA COUNTER

## ACCESSORIES

---

### Drawer pedestal with central lock and castors

Dimensions mm H x W x D	Drawers	Item no.
490 x 424 x 424	2	B36600421
490 x 424 x 424	3	B36600431

---

### Shelf pedestal

Dimensions mm H x W x D	With/without castors	Shelves	Item no.
490 x 424 x 424	With	1	B36600111
490 x 424 x 424	With	2	B36600121
425 x 424 x 424	Without	1	B36600110
425 x 424 x 424	Without	2	B36600120

---

### Base for shelf pedestal without castors

Item no.

B366010

---

### Bag shelf

Incl. brackets

For base module

For steel front  
Item no.

1100 mm straight counter	B360010113
1500 mm straight counter	B360010153
45° curved counter	B360010453
60° curved counter	B360010603

# LOCATIONS

WE ARE LIBRARY PEOPLE®



## DENMARK

Lammhults Biblioteksdesign A/S  
Dalbækvej 1  
6670 Holsted

bci@bci.dk  
www.bci.dk

## SWEDEN

Lammhults Biblioteksdesign AB  
Odlarevägen 16  
226 60 Lund

eurobib@eurobib.se  
www.eurobib.se

## UNITED KINGDOM

thedesignconcept Ltd.  
The Old Bakery,  
10 Greenless Road  
Cambuslang Belgrave Street  
Glasgow G72 8JJ

info@thedesignconcept.co.uk  
www.thedesignconcept.co.uk

## FRANCE

BC Intérieur Sarl  
6 allée Kepler  
77420 Champs sur Marne

bci@bcinterieur.com  
www.bcinterieur.com

## GERMANY

Schulz Speyer Bibliothekstechnik AG  
Hafenstraße 2  
67346 Speyer

sales@schulzspeyer.de  
www.schulzspeyer.de

## NORWAY

BS Eurobib AS  
Alf Bjerckes Vei 20  
0582 Oslo

post@bseurobib.no  
www.bseurobib.no

## BELGIUM

SBNL - Schulz Benelux BVBA  
Appelweg 94 C  
3221 Holsbeek

info@sbnl.be  
www.sbnl.be